



FALL 2010

SCHEDULE OF CLASSES

August 30 to December 19, 2010

Important Dates



Fall 2010

Registration Dates

EOPS/DSPS (in person or on-line)..... May 25 - 27, 2010
 Continuing Students (on-line only)May 28 - June 11, 2010
 New Students (on-line only)June 12, 2010 or after
 Open enrollment (in person or on-line).....August 9, 2010 or after

Fall 2010 Semester

Begins.....**August 30, 2010**

Ends.....**December 18, 2010**

First day to submit Application for Graduation.....**August 30, 2010**

Last Day To/For:

Add for semester length courses..... September 10, 2010
 Refund September 13, 2010
 Drop with a refund or without paying the fees..... September 13, 2010
 Drop without a "W" in person..... September 24, 2010
 File for Pass/No Pass September 24, 2010
 Drop without a "W" by WEB September 26, 2010
 Submit Application for Graduation..... October 8, 2010
 Drop with a "W" In Person November 19, 2010
 Drop with a "W" by WEB..... November 21, 2010

Holidays - No Classes

Labor Day.....September 6, 2010
 Veteran's DayNovember 11, 2010
 Thanksgiving Holiday November 25 - 28, 2010

Final Examinations:

- See Final Exam Schedule on page 111.

Room Changes:

- Due to ongoing construction, rooms may have changed after the schedule was printed. Please check the college website (www.latic.edu) for updates.

Refund

Request any allowable refund for classes from the College Business Office.

Full refund - 10% of class time usually during the first week of instruction. **No refund thereafter. Enrollment fees will be charged for classes dropped after this deadline.**

Admissions Office Hours

Monday - Thursday.....8:30 a.m. - 7 p.m.
 Friday:.....8:30 a.m. - 3 p.m.

Business Office Hours

Monday - Thursday.....8:30 a.m. - 7 p.m.
 Friday:.....8:30 a.m. - 3 p.m.

Counseling Center Hours

Monday - Thursday.....8:00 a.m. - 7 p.m.
 Friday:.....8:00 a.m. - 3 p.m.

Remember: It is the student's responsibility to drop their classes.

ATTENTION STUDENTS: ENROLL EARLY!!

For more information on how to enroll in your classes or to have other Student Services questions answered or about our "NEW" Queuing System located in the Student Services (ST) Building – First Floor, please refer to page 99.

Open Enrollment

Unless specifically exempted by law, every course for which State Aid is claimed is fully open to any person who has been admitted to the college and who meets the appropriate recommended academic prerequisites.

Accreditation

Los Angeles Trade-Technical College, a California public, tax-supported community college, is officially accredited by the Western Association of Schools and Colleges and is fully approved by the Board of Governors of the California State University and independent colleges and universities to give full credit for appropriate courses completed. The Culinary Arts program is also accredited by the American Culinary Federation and Educational Institute. The Registered Nursing program is also accredited by the National League of Nursing.

Accuracy Statement

The Los Angeles Community College District and Los Angeles Trade-Technical College have made every effort to make this schedule accurate and may, without notice, change general information, courses, or programs offered. The reasons for change may include student enrollment, level of funding, or other issues decided by the district or college. The district and college also reserve the right to add, change, or cancel any rules, regulations, policies and procedures as provided by law.

A MESSAGE FROM THE PRESIDENT

Welcome to Los Angeles Trade-Technical College!

We are excited that you have selected our school to further your education. We are truly unique among community colleges in that more than 75% of our programs are in the career-technical disciplines. This gives you yet another option to enter the global workforce with a two-year degree or certificate. If your career pathway involves transferring to a four-year university, we also have the classes necessary to make that choice available to you.

This school is focused on students and their success. Look through the pages of this schedule and you will find a very robust list of course offerings, in addition to information about resources designed to help you succeed in your educational journey. Make sure you learn about Financial Aid, our EOPS program, counseling, Gain/CalWORKS, our tutoring centers and our Transfer Center. These offices will assist you in attaining your goals and will make your Trade Tech experience that much more worthwhile. As a student, please get involved with your college. It's important to join the Associated Student Organization, which every year, plans some tremendous cultural and entertainment events on campus.

One thing you will notice this semester, is that our construction program is in full swing. We have two new South Campus buildings, and we are renovating both the A-building and the library. These changes will continue to polish the image of our college, and will make us a true hub of lifelong learning for our community.

Again, welcome, and we look forward to making your educational dreams come true.

Dr. Roland "Chip" Chapdelaine



President



LOS ANGELES COMMUNITY COLLEGE DISTRICT • 770 W. Wilshire Blvd., Los Angeles, California 90017 • (213) 891-2000

Board of Trustees

Mona Field,
President
Georgia L. Mercer,
Vice President
Kelly G. Candaele
Tina Park
Nancy Pearlman
Miguel Santiago
Sylvia Scott-Hayes
Rodney D. Robinson,
Student Trustee

District Administration

Dr. Tyree Wieder,
Interim Chancellor
Dr. Adriana D. Barrera,
Deputy Chancellor
John Clerx,
Vice Chancellor for Educational Support Services
Gary Colombo,
Vice Chancellor for Institutional Effectiveness
Marvin Martinez,
Vice Chancellor for Economic & Workforce Development
Larry H. Eisenberg,
Executive Director, Facilities Planning & Development

Camille A. Goulet,
General Counsel
Jeanette Gordon,
Chief Financial Officer/Treasurer

College Administration

Dr. Roland "Chip" Chapdelaine,
President
Dr. Kathleen Burke-Kelly,
Interim Vice President, Academic Affairs
Ramon S. Castillo,
Vice President, Student Services
Marcy Drummond,
Vice President, Workforce & Economic Development
Dr. Mary Gallagher,
Vice President, Administration
Leticia Barajas,
Dean, Academic Affairs
Dr. Raul Cardoza,
Dean, Enrollment Management

Dr. Theda Douglas,
Dean, Student Services
Vincent Jackson,
Dean, Academic Affairs
Cynthia Morley-Mower,
Dean, Academic Affairs
Anna Badalyan,
Dean, Institutional Effectiveness
Dorothy Smith,
Dean, Matriculation & Student Success
Derek Majors,
Associate Dean, EOPS/CARE
Luis Dorado,
Assistant Dean, Student Activities/ASO Advisor

TABLE OF CONTENTS

Vision and Mission of LATTC.....	3	Family Education Rights and Privacy Act.....	90
Fall 2010 Enrollment Process.....	4	Fee Exemption for Special Part-Time & Full-Time Students Grades K-12.....	90
Steps to Enroll.....	5	Freedom of Speech Area and Procedures.....	90
Orientations.....	6	Grades and Grade Changes.....	90
Registration.....	7	Graduation.....	91
Fees At a Glance.....	8-9	Graduation Application for Degrees/Certificates.....	91
Taking the Assessment Test.....	11	Hope Scholarship Tax Credit.....	91
Prerequisites, Co-requisites & Advisories.....	12	Limited English Proficiency.....	91
Enrollment Information.....	13	Estudiantes Con Falta de Competencia en Lengua Inglesa.....	91
Adding Classes.....	13	Nondiscrimination Policy.....	91
Auditing Classes.....	13	Normas del Plantel Referentes a la Discriminación.....	91
Basic Skills Enrollment Limitation.....	13	Open Enrollment.....	92
Dropping/Withdrawing From Classes.....	13	Parking on Campus.....	92
Concurrent Enrollment/Class Conflict.....	13	Sexual Assault.....	92
Cancelled Classes.....	13	Smoking/Non-Smoking Policy.....	92
Course and Activity Repetition for Additional Credit.....	13	Social Security Numbers/Student Identification Number.....	92
Course Repetition to Improve Substandard Grades.....	13	Standards of Student Conduct.....	92
Course Repetition Under Special Circumstances.....	13	Disciplinary Action.....	94
International Student Admission.....	13	Student Grievance Procedures.....	94
Parking Permits.....	14	Ombudsperson.....	94
Parking Locations.....	14	Student Records and Directory Information.....	94
Registration by Proxy.....	14	Student Rights and Responsibilities.....	95
Study Load.....	14	Student Right to Know.....	95
Veterans, Selected Reservist, National Guard, & Eligible Dependents.....	14	Transcripts.....	95
Plan A General Education.....	15	Verifications of Enrollment.....	95
Plan B General Education.....	16	Viewing Your Records.....	95
CSU General Education.....	17	Campus Offices & Services.....	96
IGETC General Education.....	18	Admission And Records.....	96
Educational Programs.....	19	Bridges to Success Center.....	96
Fall 2010 Schedule of Classes.....	20	Career Center.....	96
Web Enrollment.....	54	Child Development Center.....	96
The Financial Aid Application Process.....	57	Cooperative Agencies Resources for Education (C.A.R.E.).....	96
The Ability to Benefit (ATB) Test.....	58	Counseling Services.....	96
BOG Fee Waiver Application.....	59	Disabled Student Program & Services (DSP&S).....	96
Admissions Application.....	63	Extended Opportunity Program and Services (EOPS).....	96
Noncredit Classes.....	79	Financial Aid Services.....	96
LATTC On-line Classes.....	82	GAIN /CALWORKS.....	97
Cooperative Education.....	85	Information Center.....	97
Apprenticeship Education.....	86	International Students.....	97
Instructional TV Program- The Weekend College.....	87	Library.....	97
Student Resolution Process.....	88	Matriculation.....	97
College & District Policies.....	89	Puente Program.....	97
Academic Freedom.....	89	Student Activities Office.....	97
Academic Standards.....	89	Student Employment Center.....	97
Accuracy Statement.....	89	Student Health Center.....	97
Admission and Resident Classification of Non-Citizens.....	89	Umoja Program.....	97
Diversity.....	89	University Transfer Center.....	97
Attendance.....	89	Associated Students Organization (ASO).....	98
Conduct Expected of Students.....	89	New Student Services Numbering System.....	99
PASS/No PASS.....	90	LATTC Foundation.....	100
Drug-Free Workplace Policy.....	90	Directory.....	101
E-Mail Account for Enrolled Students.....	90	Public Transportations.....	108
Educational Environment Policy.....	90	Fall 2010 Final Exam Schedule.....	111
Emergency Information.....	90	Student Parking Guidelines.....	112

Vision and Mission of LATTC

College Vision through 2015

Los Angeles Trade-Technical College (LATTC) will be a global leader known for effectively incorporating leading-edge theories, proven educational practices, hands-on experiences and technology into its career technical and professional programs. LATTC graduates will be in high demand. Many will become community and business leaders and innovators.

Our Mission is to

Provide our students and community with high-quality technical and professional educational options that flexibly meet their life-long career development and academic goals; foster a climate of life-long learning; prepare our students to participate effectively in our democratic society; and generate economic development with our educational, governmental, community, and business partners.

Our Values are

Learning

We are committed to help all students define and attain their learning objectives whether career technical, professional, transfer, or basic skills. We are dedicated to student success and judge our success by their learning outcomes. Our faculty, administration and staff commit to and attain annual learning objectives.

Excellence

We set and meet the highest standards. We anticipate change. We regularly evaluate our programs, systems, facilities, equipment and teaching methods to incorporate improvements. We recruit the best faculty and staff and commit appropriate resources and time to their continuous development.

Respect

We value diversity in perspective, thought, and culture. We believe it contributes to creative approaches and solutions to problems or opportunities. Regardless of the extent of our differences, we are inclusive, civil, and collegial with each other, our students, our community, and all others.

Integrity

We say what we mean and we do what we say. We hold ourselves accountable to each other and our community. We meet or exceed professional standards and legal requirements. We honor the public's trust by providing high quality services, while using our resources prudently and efficiently.

Teamwork

We believe that teams working collaboratively produce superior results. We foster collaborative relationships and teams, encompassing both campus-wide and external membership, to optimize the quality, acceptance, and implementation of their recommendations.

Decision-making

In the spirit of shared governance, we strive to keep the whole campus informed on emerging issues and involved in key decisions. We make sound data-based decisions that address multiple perspectives and account for short-and long-term implications.

FALL 2010 ENROLLMENT PROCESS

FOR LATTC NEW OR RETURNING STUDENTS

Each box represents a process. For more information about the enrollment process please visit the matriculation webpage: www.lattc.edu/dept/tmat/matriculation.htm or stop by the Information Center, ST-Lobby.

Step 1

Fill out the application and submit it to Admissions & Records (ST-Lobby).
Admissions & Records: 213- 763-5300. You can also fill out the application on-line at <http://www.lattc.edu/dept/TADR/admissions.htm>

Step 2

Take a Computerized Assessment Test for non-exempt students (ST-303).
See page 9 for hours; for more information please call 213-763-5339.

Step 3

Attend an Orientation.
For orientation dates and times, see page 6.

Step 4

Speak to a counselor (ST-416).
The counselor will assist with course selection for semester &/or short-term sessions. To contact the Counseling office please call 213-763-7354.

Step 5

Register for classes.
You may register for classes online (www.lattc.edu) any time on or after your registration appointment date. You may also turn in the Course Request cards during "In-Person Registration" in Admissions & Records, ST-Lobby (Please see inside cover for exact dates).

Step 6

Submit completed Board of Governor's Grant (fee waiver), to the Financial Aid Office (ST-214).
You may also submit the financial aid FAFSA Application online in the Financial Aid Lab (ST-314). For more information please call 213-763-7082.

Step 7

Go to the Business Office (ST-Lobby) to pay for required fees and obtain parking permit.
Business Office #: 213-763-7225.

Step 8

Bring your current Fee Receipt to the Information Center (ST-Lobby) to obtain your free LATTC Student ID.
For more information please call 213-763-5337.

* For more detailed explanation about the Enrollment Process, please refer to page 5.

STEPS TO ENROLL

STEP 1: APPLY

Submit a completed application to the Admissions & Records Office in ST-Lobby.

- Documents you need to bring: Recommended: Valid photo identification; verification of immigration status for non citizens.
- For more information regarding the exemption from payment of nonresident tuition for nonresident students who have attended a high school in California and received a high school diploma or its equivalent (Assembly Bill 540), see the Information Center or the Admissions Office in ST-Lobby.
- For K-12 students who are currently attending a middle school or high school, a Supplemental Application for Admissions of Students in Grades K-12 must be submitted together with the LATTC application. These forms must be approved by an Academic Administrator. For more information, please see the Bridges to Success Center in ST-316.

STEP 2: ASSESSMENT TEST

If you are registering for English, Math, or English as a Second Language (ESL) class during this semester you will need to take the Assessment Test which is offered in ST-303 on a walk-in, first come, first served basis. For testing hours call (213) 763-5339.

- You need to bring a valid picture ID (no exceptions) and student ID number from the college.
- Exemption Criteria: You may be exempt from taking the assessment test if you meet and bring proof of any of the following criteria:
 - a) Valid assessment test scores from LATTC or another college taken within the last 2 years.
 - b) Completion of English 64 and Math 101 (or higher) at LATTC with a grade of "C" or better.
 - c) Transcripts which show the completion of English and Math courses at another accredited college with a "C" or better.
 - d) AP English and Calculus Exam with Scores of 3 or higher taken within the last 2 years.

STEP 3: ORIENTATION

LATTC currently offers two forms of orientation: In-person (highly recommended), or On-line. You may participate in any one. Please come to the Information Center for more information in ST-Lobby.

Exemption Criteria: You may be exempt from participating in orientation if earned an AA/AS or higher degree from an accredited institution. Please bring a copy of transcript or diploma to ST-Lobby to satisfy this exemption.

STEP 4: MEET WITH A COUNSELOR

During the registration period, counselors will be available to assist students on a limited walk-in basis in ST-416.

Documents you need to bring: your assessment results if you are registering for an English, Math, or ESL class.

STEP 5: REGISTER FOR CLASSES

You may register for classes any time on or after your registration appointment date and time. You may register online through the Student Information System or in –person during the In-Person Registration period in ST-Lobby. FOR SPECIFIC DATES FOR EACH METHOD OF REGISTERING, PLEASE REFER TO THE IMPORTANT DATES PAGE IN THE CURRENT SCHEDULE OF CLASSES.

STEP 6: FINANCIAL AID

You should apply for a Fee Waiver and Free Application for Federal Student Aid (FAFSA) as soon as possible!

Visit the Financial Aid Office in ST-Building, Second Floor, the Financial Aid Lab in ST-314, or call (213) 763-7082.

In order to qualify for financial aid you need to have a High School Diploma or GED or a passing score on the Ability to Benefit Test, which is administered in the Assessment Center in ST-303.

STEP 7: PAYING FEES

You can pay for your classes (if you are not receiving financial aid), pick up your Fee Receipt, and pay for your parking permit at the Business Office in ST-Lobby.

STEP 8: LATTC PHOTO IDENTIFICATION CARD

To receive your LATTC Photo ID, please go to the Information Center in ST-Lobby.

ID Office hours: Monday thru Thursday, 10:00 a.m. to 7:00 p.m. For more information call (213) 763-5337.

Documents you need to bring: your LATTC Fee Receipt for the current semester.

ORIENTATIONS

New Student In-Person Orientation

(semester begins August 30, 2010)

All orientations will be held in TE-111

May, 2010

Monday, May 24th – 1:00pm

June, 2010

Wednesday, June 16th – 5:30pm

Monday, June 28th- 10:30am

July, 2010

Wednesday, July 7th- 5:30pm

Thursday, July 15th -10:30am

Tuesday, July 20th- 5:30pm

Thursday, July 22nd – 10:30am

Tuesday, July 27th -10:30am

Thursday, July 29th -5:30pm

August, 2010

Thursday, August 12th- 10:30am

Tuesday, August 17th- 5:30pm

If you have any questions about the orientations, please call (213) 763-5336 or stop by the Information Center in ST-Lobby.

Please note: Orientation dates are subject to change. Please call (213) 763-5336 to verify.

REGISTRATION

FOR ALL STUDENTS THROUGH THE INTERNET

How to apply to LATTC on-line:

New & Returning Students:

Step 1: Fill out the Application:

- Go to www.laccd.edu
- Click on Admissions & Registration
- Click on Apply for Admission

Step 2: After submitting your application, you will receive an email response within 48 hours. You may then receive your appointment registration.

Continuing Students:

- Go to www.laccd.edu
- Click on Student Information System

Assistance for the hearing impaired

If you are Hearing Impaired and need an interpreter or other related services, please contact the Disabled Student Services at (213) 763-3773.

The screenshot shows the LATTC website interface. At the top left, it displays the college's name and address: LOS ANGELES TRADE-TECH COLLEGE, 400 W. WASHINGTON BLVD, LOS ANGELES, CA 90015, 213-763-7000. The LATTC logo is prominently featured. To the right, there are buttons for 'Apply Now' and 'Register for Classes'. Below the header is a navigation menu with links for 'Why LATTC', 'Students', 'Faculty & Staff', and 'Community'. A sidebar on the left lists various services such as 'About Trade-Tech College', 'Academic Affairs', 'Admissions', 'Bookstore', 'Bridge To College (K-12)', 'Counseling', 'Department Websites', 'Employment Opportunities', 'Foundation', 'Learning Center / Tutoring', 'Library', 'Sheriff's Department', 'Student Services', 'Campus Maps & Directories', 'Grand Theater', 'Workforce & Economic Development', and 'LACCD'. The main content area features a banner for 'MASTER A TRADE EARN YOUR DEGREE FASHION DESIGN' with a 'CLASS SCHEDULE - Click Here' button. To the right of the banner is a vertical column of service buttons: 'CLASS SCHEDULES & CATALOG', 'MYLATTC PORTAL STUDENT EMAIL ACCESS', 'TUTORING AND BASIC SKILLS', 'FINANCIAL AID FEE WAIVER AVAILABLE', 'ACCREDITATION COUNTDOWN', 'PARKING INFORMATION', and 'ONLINE CLASSES HYBRID & FULLY ONLINE'. At the bottom of the banner area, there is a 'SPRING CLASSES FIND CLASSES TODAY' button.

Your Appointment to Register Can be Used for ANY College in the LACCD!

With your appointment to register, you can use the college's web-based registration system to register for classes at any of the colleges in the Los Angeles Community College District (LACCD) - East L.A. College, L.A. City College, L.A. Harbor College, L.A. Mission College, Pierce College, L.A. Trade Technical College, L.A. Southwest College, L.A. Valley College, and West Los Angeles College. You can register for Instruction Television (ITV) classes as well. You do not need to apply separately in order to register at these colleges.

12,000 Classes to Choose From!

The opportunity to enroll at multiple colleges gives you access to over 12,000 classes throughout the nine colleges in the Los Angeles Community College District.

Search for Classes on the Web!

Using the college's web registration system, you can search for available classes at any college in the Los Angeles Community College District. You can even search for a particular course by time and days of the week!

FEES AT A GLANCE

Enrollment Fee

\$26* per unit for California residents, with no maximum.

* Subject to change by the California Legislature.

The State Education Code requires Community Colleges to charge enrollment fees of each student enrolling in college. The fee prescribed by these sections shall be twenty-six dollars (\$26*) per unit per semester with no maximum per semester. Non-resident students paying non-resident fees are required to pay the twenty-six dollars (\$26*) per unit enrollment fee. Fees must be paid at the time of registration or risk being excluded from class. Enrollment fee waivers are available to qualifying students. Contact the Financial Aid Office in Student Services Building, ST-214 or call (213) 763 - 7082 for information about fee waivers prior to payment.

Health Services Fee

* \$11 per semester

Spring & Fall

* \$8 per semester

Summer & Winter Intersession

* Subject to change by the LACCD Board of Trustees.

The Board of Trustees has required that each college collect a mandatory eight/eleven-dollar (\$8/\$11) health services fee. This fee must be paid at the time of registration. The Los Angeles Community College District Policy exempts the following students from paying the student health fee: (a) students who depend exclusively on prayer for healing in accordance with the teaching of a bona fide religious sect, (b) students who are attending classes under an approved apprenticeship training program, (c) non-credit education students, (d) students enrolled in District colleges exclusively at sites where student health services are not provided, (e) students who are enrolled District colleges exclusively through Instructional Television or distance education classes, (f) student who are enrolled in District colleges exclusively through contract education. Students exempted under the provisions of (b), and (c) above are eligible to receive the services of the college health program; all other exempted students are not eligible to receive the services.

Students who are exempted may obtain a Health Services Exemption Form from the Admission Office (ST-106). Completed forms must be returned to the Admissions Office for approval.

Non-Resident Tuition Fee

Out-of-state students: \$186 per unit plus enrollment fee of *\$26 per unit

Foreign students: \$186 per unit plus a \$18 per unit fee and enrollment fee of *\$26 per unit

Foreign Student Processing Fee
Per semester: \$25 *Non-refundable*

The 2010-2011 tuition for non-resident students is \$186 per unit plus the \$26* per unit enrollment fee. Fees must be paid at the time of registration or risk being excluded from class.

The 2010-2011 tuition for foreign students is \$186 per unit plus the \$26* per unit enrollment fee and the Board of Trustees adopted \$18 per unit fee pursuant to Education Code Section 76140. These fees are subject to change each academic year. Foreign students must pay a non-refundable \$35 application fee.

Effective Fall Semester, 2003, the Board established a twenty-five dollar (\$25.00) per semester processing fee for students classified as nonresidents who are both citizens and residents of a foreign country.

Nonresident tuition fee exemption for students taking either a total of four (4) UNITS or fewer or ONLY one class which is six (6) UNITS or fewer. Beginning with the Winter 2009 semester, all nonresidents who enroll for either: (a) a total of four UNITS or fewer, or (b) only one class which is six UNITS or fewer, shall be exempt from the nonresident tuition fee (Board Rule 8100.15, EC 76140(a)(1)). **Note:** Fees paid by federal financial aid funds will be subject to a special refund calculation.

Resident and Non-Resident Tuition Refund Schedule

Class Type	Date Request Time Stamped	Refund
Regular Length (Fall & Spring)	Through second week of instruction	Full Refund
	After second week of instruction	No Refund
Short Term, Summer, Winter Intersession (Less than regular length)	Through 10% of class length	Full Refund
	After 10% of class length	No Refund

Auditing

\$15 per unit

Non-refundable unless the class is cancelled

STUDENTS MAY BE PERMITTED TO AUDIT A CLASS UNDER THE FOLLOWING CONDITIONS:

1. Complete an application and be authorized to register in the college
2. Obtain permission of the instructor of the class at the beginning of the semester
3. No student auditing a course shall be permitted to change his or her enrollment in that course to receive credit for the course
4. Students enrolled in classes to receive credit for ten or more semester UNITS shall not be charged a fee to audit three or fewer semester UNITS unless they drop below 10 UNITS during the semester
5. Priority in class enrollment shall be given to students desiring to take the course for credit

Parking Permits

\$10 - Summer & Winter

\$20 - Spring & Fall

A limited number of student Parking Permits are available for purchase at the Business Office for \$20 per permit per semester for Spring and Fall, \$10 for Summer and Winter. Parking in areas marked "Parking by Permit ONLY" will be restricted to vehicles displaying a valid permit. Vehicles parking on college property without a valid permit will be subject to citation. **There is no replacement for lost or stolen permits.**

ASO Fee

\$7 per semester

The \$7 ASO membership fee is automatically charged, UNLESS the student declines. This is NOT a mandatory fee. ASO fees do not apply for Summer sessions and Winter Intersession.

Student Representation Fee

\$1 per semester - *Non-refundable*

The student representation fee is a mandatory fee to provide support for student representatives who state their view points before various governmental offices and agencies. Students may for religious, political, financial or other reasons, refuse to pay the fee in writing on a form provided for this purpose.

MTA TAP Cards

\$20 - Initial Card

\$15 - Reload

Students with 12 or more units may purchase a TAP Card which allows unlimited ridership on Metro bus and train lines. The initial card is \$20, reloading a card for a new semester is \$15. Lost cards may be replaced for an additional \$5.

FEES AT A GLANCE

CONTINUED

Enrollment Fee Assistance

For immediate enrollment fee assistance, students who are unable to pay the enrollment fee should complete the Board of Governors' Enrollment Fee Waiver application and submit it to the college Financial Aid Office for processing prior to payment of their enrollment fees. Students who complete a Free Application for Federal Student Aid (FAFSA) will be given an automatic fee waiver based upon the information reported on the application. There is no need to complete a paper application if you have received notification of an automatic fee waiver for the 2010-2011 school year. Go directly to the Business Office, Cashier Window, ST-109, to pick-up your registration receipt. Students who had a fee waiver last year must submit a new application for the new year, which includes Summer 2010, Fall 2010, Winter-Intersession 2011, and Spring 2011. Applications are available in the class schedule, the Information Center, and the Financial Aid Office. There are three ways to qualify:

Method A (BOG A) – For families or students who receive TANF/CALWORKS, General Relief (GR), Supplemental Security Income (SSI/SSP).

Method B (BOG B) – For families or students whose family income and size fall with the following limits:

Board of Governors Fee Waiver Program (BOGFW - B) 2010 - 2011 Income Standards

Family Size	2009 Income	Family Size	2009 Income
1.....	\$16,245	5.....	\$38,685
2.....	\$21,855	6.....	\$44,295
3.....	\$27,465	7.....	\$49,905
4.....	\$33,075	8.....	\$55,515
		Each Additional Family Member	\$5,610

Special Classification Enrollment Fee Waivers:

You also be eligible for a BOG if

- you are a dependent of a deceased or disabled veteran of the U.S. Military
- you are a recipient of a Congressional Medal of Honor or a child of a recipient
- you are a dependent of a victim of the September 11, 2001 terrorist attack
- you are a dependent of a deceased law enforcement/fire suppression person killed in the line of duty.

Proof of these benefits is required.

Method C (BOG C) – Students who do not meet the above criteria, but have financial need as established by the College Financial Aid Office, may also be eligible for an Enrollment Fee Waiver. To qualify, students must complete a Free Application for Federal Student Aid (FAFSA) and provide proof of prior year income. Processing of this type of fee waiver takes approximately ten working days.

Fee Exemption: Attention Board of Governors Fee Waiver Students

Beginning fall 2006, all students will be charged the health fee (\$11 for fall and spring and \$8 for summer and winter). This fee will no longer be waived for students who are eligible for a fee waiver. Please feel free to contact the Financial Aid Office on extension 7082 if you have any questions. There are no fee waivers for audited classes. Other financial aid may be available to students who meet the qualification requirements. Students with questions concerning financial aid eligibility should contact the College Financial Aid Office, Student Services Building ST-214.

Refund Policy

All refunds must be requested in the Business Office (ST-109).

- Full semester (Fall & Spring) refunds are issued for classes dropped through the end of the second week of instruction. Thereafter, no refund is authorized, except when college action to cancel or reschedule a class necessitates the drop.
- For all short term, Summer session, and Winter Intersession classes, a refund is issued for classes that are dropped prior to a period of time equal to 10% of the total class time, must usually be dropped during the first week of class. Thereafter, no refund is authorized, except when college action to cancel or reschedule a class necessitates the drop.
- If college expenses have been paid by federal financial aid funds, any refund due will revert to the financial aid program rather than to the student.
- The date used for refund purposes is the date on which the drop is processed, regardless of when separation may have occurred.
- All non-resident refunds will be made by mail or credit card.
- All students please check for refund disclaimer in section on course repetition.

Campus Refund Procedure

1. Student must drop class by refund deadline.
2. In order to receive a refund, the **student must request the refund in the Business Office** (ST-109).
3. There shall be no refund disbursements before the first day of the semester unless the student withdraws from all colleges in the District.
4. The campus Business Office will make no refund disbursements during the first 2 weeks of the semester.
5. Students who have paid their fees by check shall get their refunds pending verification that their checks have cleared the bank.
6. Cash refund limit is \$100.00

Instructional Materials

Students may be required to pay for or provide instructional and other materials required for a credit or noncredit course. Such materials shall be of continuing value to a student outside of the classroom setting and shall not be solely or exclusively available from the District. If class material are provided, the student may be assessed those costs for materials. Payment and verification of material fees is to be completed at the college Bookstore or Business Office K-126.

Returned Check Fee

A \$10 fee is charged for any check returned by the bank unpaid. A hold is placed on the student's record until the financial obligation is settled.



Attention Students: Need help paying your fees?

Enrollment fees for all California community colleges are \$26 per unit.

Before you write out that check or charge your credit card, why not apply for financial aid? Did you know that:

- Many students are eligible to have their fees waived, but they don't apply.
- The eligibility criteria for fee waiver is more lenient than for Federal Financial Aid.
- If you are eligible for a fee waiver, you may request a refund of the enrollment fees you may have already paid.
- Other kinds of financial aid are available as well. Apply for financial aid in addition to the fee waiver by using the Free Application for Federal Student Aid (FAFSA) online at www.fafsa.ed.gov, or by paper application.
- By applying via the FAFSA, you will be considered for all of the financial aid programs your college participates in, including the fee waiver
- You have nothing to lose; it's a free application so don't delay, apply today!
- See center insert for full information.

The Trade-Tech

Financial Aid Office

is located in the Student Services Building,
ST-214, (213) 763-7082

Financial Aid/EOPS Computer Lab is located in
Student Services Building ST-314.

TAKING THE ASSESSMENT TEST

In order to help students get the most out of their higher education, the college provides tests that assess a student's general educational background and skills in: Math, English, and English as a Second Language (ESL). The Matriculation Department is concerned that you successfully complete your course work at LATTTC by selecting courses that will meet your educational goals. These tests help students select courses that are realistic and compatible with their level of academic preparation and experience.

LATTTC offers computerized assessment testing. The student will receive a copy of their assessment results. You may take your assessment test results to the counselors who will make appropriate course recommendations.

Assessment Center

Phone: (213) 763-5339

Location: Building ST-303

Office Hours:

Monday:	8:30 a.m. to 5:00 p.m.
Tuesday:	8:30 a.m. to 5:00 p.m.
Wednesday:	8:30 a.m. to 8:00 p.m.
Thursday:	8:30 a.m. to 5:00 p.m.
Friday:	8:30 a.m. to 2:00 p.m.

Please REMEMBER that during testing:

- No food or drinks
- No children
- No calculators
- Cell phones and pagers MUST be turned OFF
- All electronics devices need to be turned off.

Frequently Asked Questions:

When can I take the test?

The test is available on a walk-in basis in ST-303 any time after you have submitted a current application to Admissions & Records. Please bring your LATTTC/LACCD Student I.D. number.

Do I need to study for this test?

No. This is not a pass or fail test. However, it is important for a student to take the test to the best of their ability. This test affects the number of Math and English courses a student must complete in order to meet graduation/transfer requirements. If the student disagrees with scores, they have the right to challenge their test scores.

What do I need to bring with me?

Students need to bring a valid photo ID in order to take the test. There are NO EXCEPTIONS to this policy! The ID must be original, No photocopies. Examples of ID include a California Driver's License, California ID, a pass-port, high school picture ID, etc.

How long does the test take?

The test is self-paced. Most students finish in about 2 hours. Please arrive at least two (2) hours before closing time.

How long are the test scores valid?

Test scores are valid for 2 years. Retesting for General Placement of English/Math/ESL is only every two years. You may challenge your placement results.

What does it take to be exempt from taking the assessment test?

The student must meet one of the following criteria:

- Valid assessment scores from LATTTC or another college taken within the last 2 years.
- Completion of English or Math courses at any accredited college with a grade of "C" or better (transcripts required).
- AP English or Calculus Exam Scores of 3 or higher taken within the last 2 years.

Transcript, test scores, or a college diploma MUST be provided as proof for assessment test exemption to the Assessment Center.

The Assessment Center offers "Tests of Adult Basic Education (TABE) a diagnostic test. This test will measure the student's grade level in Language, Math, and Reading. This is not a pass/fail test. This is a timed test. Test is available through department referral. Please see the Assessment Center for further information.

PREREQUISITES, CO-REQUISITES & ADVISORIES: YOUR PATH TO ACADEMIC SUCCESS!

Prerequisites, Co-requisites and Advisories

What Do They All Mean?

Prerequisite is a condition that a student has to meet prior to enrolling in the class. Completion of the prerequisite demonstrates that you are ready and able to succeed in the course you want to take. A prerequisite is usually either another course, or a specific test score on a standardized test.

Co-requisite is a course that must be taken at the same time as the course you want to take.

Advisory or recommended preparation means that you are advised, but not required, to have taken the course(s) or met the test scores before enrolling in the class.

PLEASE CHECK YOUR CLASSES CAREFULLY:

Prerequisites are enforced!

Want to take a course with a pre-requisite? You can satisfy a prerequisite several ways:

1. Take the prerequisite course at Trade-Tech or another college in the District and achieve a grade of "C" or better, so that it shows on your official transcript;
2. Provide proof that you've successfully completed the requirement(s) at another college. You can bring transcripts or assessment scores from another school to the Matriculation Department and they will be reviewed. If your course is approved, you'll be given a clearance to register.
3. Take a test – known as a challenge exam – to show that you have the knowledge and skills necessary to successfully prepare you for the course you want to take;
4. If the course you want to take has an assessment test score as a prerequisite, you'll need to visit the Assessment Center and complete the required test. Your score will then be given to you, and the prerequisite(s) will be cleared once you receive a copy of your placement score(s).

If you have any questions or need more information, please contact the Matriculation Office at (213) 763-5339.

Challenging a Pre- or Co-requisite

If you want to challenge a prerequisite or co-requisite, i.e., you have not met the necessary prerequisite conditions but believe you should be allowed into the class anyway, you can challenge it if:

1. The prerequisite has not been made reasonably available;
2. The prerequisite is not valid because it is not necessary for success in the course you want to take;
3. The prerequisite is discriminatory or applied in a discriminatory manner;
4. You believe you have the knowledge or ability to succeed in the class without the prerequisite.

If you believe any of the above is true, you have the right to challenge the prerequisite or co-requisite. To obtain a Challenge Form, please visit the Matriculation Office or the Assessment Center and follow their directions.

ENROLLMENT INFORMATION

ADDING CLASSES

Only students who have been admitted to the College and are in approved active status may add open classes. Any applicable fees for increased UNITS will apply.

Adding Classes Prior to the Start of the Semester - enrolled students may add a class prior to the first day of the semester/session by completing an Add/Drop Permit during the in-person registration process, or by using the web enrollment system at www.lattc.edu.

During Late Add Period – students can add an open class (or classes) by presenting a signed Add Permit to the Admissions and Records office. The Add Card must be signed by the instructor of record or their designee and returned to Admissions and Records the same day it was issued. A signed copy must be presented to the instructor at the next class meeting.

After Late Add Period – there is no petition process for late adds after the deadline, however, students may add any open entry/open exit class without an Add/Drop Permit.

AUDITING CLASSES

Classes may be audited on a space available basis. There is a \$15 per unit non-refundable fee to audit a class; for more information, please see the "Fees at a Glance" section of this schedule.

CONCURRENT ENROLLMENT/CLASS CONFLICT

Students are not allowed to enroll in multiple sections of the same course during a single semester. Concurrent enrollment in cross-referenced courses is not permitted, nor is enrollment in classes scheduled or conducted during overlapping times. Students violating this regulation will be excluded from both classes and be denied course credit. They will also be subject to disciplinary action. Please see Standards of Student Conduct in the current catalog for more information.

CANCELLED CLASSES

Due to low enrollment, some classes listed in this schedule may be cancelled. If a class has been cancelled, you are eligible for a refund of any fees you have paid toward that course.

COURSE AND ACTIVITY REPETITION FOR ADDITIONAL CREDIT

Certain courses may be repeated for additional credit. These courses, marked "RPT" in the class section of the college catalog, allow the student an expanded educational experience each time the student enrolls in the course. Enrollment in these courses is limited in any activity to a maximum of three repeats for a total of four (4) enrollments, regardless of the repeatability of individual courses. The activity limitation also applies to courses which are not repeatable in themselves but for which similar activities exist. For example, there are several similar course titles in Art, Music, Theater, and Physical Education which are considered to be the same activity. A student may enroll four times in courses which are considered to be the same activity. Any combination may be used as long as 4 enrollments in one activity is not exceeded. Please consult the current catalog for more information.

COURSE REPETITION TO IMPROVE SUBSTANDARD GRADES

Students may petition to repeat courses in which substandard grades (less than "C," 2.0) were awarded. See Catalog for details on Course Repletions.

COURSE REPETITION UNDER SPECIAL CIRCUMSTANCES

Repetition of courses for which substandard work has not been recorded shall be permitted only upon advance petition of the student and with written permission of the College president or their designee. Please consult the current catalog for further information.

DROPPING/WITHDRAWING FROM CLASSES

Please see the inside front cover for dates to drop or withdraw from classes.

Please note: It is the student's responsibility to drop a class they are not attending. If the class is not dropped, the student may receive an "F" in the class.

NOTICE: If you are receiving Financial Aid, you may have to repay federal funds for classes you have dropped or withdrawn from. Be sure to check with the Financial Aid Office before you stop attending classes!

INTERNATIONAL STUDENT ADMISSION

Los Angeles Trade-Technical College (LATTC) welcomes applications from international students. We also accept transfer applications for F-1 Visa students currently studying in the U.S. as well as Change of Status applications for visitors who currently have other visas. Applications may be obtained by contacting the office or on-line. The International Students Center is located in the Student Services Building, ST-415.

Application Deadlines:

- Fall Semester: July 1
- Spring Semester: December 1

NOTE: F-1 students transferring from schools within the United States (US) have a more flexible deadline; please call the International Student office for more information.

The applicant must provide:

1. The supplemental International Students Application
2. Two recent passport sized photographs of applicant
3. Copy of valid passport identification page
4. Official TOEFL scores sent directly from Educational Testing Services – this may be waived if you are from a country that uses English as its primary language of instruction or if you are transferring from a school within the United States. We also accept the International English Language Test Skills (IELTS) report and the Step Eiken in lieu of the TOEFL. Please contact us for all test cut scores.
5. Official transcripts and/or diplomas from secondary school and colleges attended – student must be a high school/secondary school graduate. If these documents are not in English, an official translation must also be submitted.
6. LATTC Affidavit of Support including an official bank statement or letter with a minimum of \$16,000 USD in available funds dated within the last 6 months
7. Non-refundable \$35 application fee – check, cash, or money order
8. Transfer students must also submit the following documents: the LATTC Transfer Approval Form, a copy of your current I-20, a copy of your visa, and a copy of the front and back of your I-94.

Please allow 2 – 4 days for application processing time once ALL documents are received by the college. Eligible students will be issued an I-20A form by LATTCC. This document can be used by the student to obtain an F-1 Visa from a US Embassy in his/her home country. Students who are already in the country may use this new I-20 to change their visa status or to complete their transfer process from another educational institution.

TUITION

International student fees are approximately \$230 per unit, subject to change by the California legislature.

HEALTH INSURANCE

Health care in the United States can be costly without proper insurance coverage. Starting in the Fall 2007 semester, LATTCC International Students will be fully covered by Blue Cross. The cost for a 6-month period of coverage is \$438, which is subject to change. The \$438 will be included as part of your LATTCC fees every Fall and Spring Semester (no waivers). Please visit our office for a copy of your benefits.

FULL-TIME COURSE LOAD

Per U.S. Citizenship and Immigration Services (USCIS) regulations, all F-1 International Students must maintain a full-time course load during the Fall and Spring semesters – certain exceptions apply, please see your Designated School Official (DSO) for more information. A full-time course load is defined as a minimum of 12 UNITS. Dropping below 12 UNITS without PRIOR written permission from the DSO places your student status at risk. F-1 students are not required to attend the Winter and Summer Sessions but may do so if they wish.

CHANGE OF STATUS

Effective April 12, 2002, the Immigration and Naturalization Service has issued an Interim Rule which requires students with B Visas to change their visa status to an F-1 Non-immigrant Visa prior to pursuing a course of study at the college. Applicants may only enroll in classes after F-1 student status has been approved by USCIS. Also note that holders of H-1, H-2, or H-3 Visas may only engage in incidental studies per USCIS regulations. If you wish to pursue a degree, please apply for a change of status to an F-1 Student Visa. Call our office for more information.

PARKING PERMITS

Parking permit fees are \$20 during the Fall and Spring semesters. All students must still display a valid parking permit for that semester. Failure to do so will result in a parking citation. To obtain your parking permit, please visit the Business Office, ST-109, during normal business hours and be a currently enrolled student.

PARKING LOCATIONS

Parking is available in the LATTCC Olive Street Parking Structure located at 2001 S. Olive Street [Across the street from the "K" building; 1/2 block South of Washington Blvd, between Grand and Olive. Entrance on Olive Street.] Parking is also located at various contracted lots adjacent to the campus. Contracted parking is subject to change based on the College's construction schedule and availability. For current information, please check our website at lattc.edu, or contact the Sheriff's Department at 213/763-3600.

REGISTRATION BY PROXY

Applications for acceptance to the college cannot be completed and signed by any person other than the applicant. An original signature is required on the application and the applicant is responsible for the correctness. If a student requests registration by proxy, a signed, completed "PROXY REGISTRATION FORM" must be presented and surrendered (at the Admissions and Records Office, ST-Lobby) by the proxy at the time of class enrollment. This document will serve in-lieu of the student's signature normally on the Course Request Card. The student assumes all responsibility for the proxy's action during the enrollment process. Proxy Registration Forms are available upon request in the Admissions and Records Office, ST-Lobby. Registration by proxy does not release the student from the responsibilities for all college rules and regulations or the mandatory intake process of Assessment and Orientation.

STUDY LOAD

A maximum of 18½ UNITS may be carried without prior approval. If a load of 18½ UNITS or more is requested, a student must file an Academic petition in the Admissions Office, ST-Lobby. Forms are available in the counseling office. Student benefits such as Financial Aid (6 UNITS minimum – 1/2 benefit) and Veterans Educational Benefits are based on a minimum full time study load of 12 acceptable UNITS. Associated Student officers and participants in conference athletics must be enrolled in at least 12 UNITS.

VETERANS, SELECTED RESERVIST, NATIONAL GUARD, & ELIGIBLE DEPENDENTS

The college is an institution of higher learning approved for Veterans, Selected Reservist, National Guard, and eligible dependents educational benefits. A large number of these individuals are currently enrolled and the college encourages students to take advantage of the benefits available. The Office of Veterans Affairs unit is located in the Admissions Office, ST-Lobby, (213) 763-5305.

Join Your Associated Students Organization Today!

Buy an ASO membership for only \$7, and enjoy these benefits all semester long!

- ASO picture ID card proving your student status and making you eligible for discounts at movies, plays, museums, dances, activities and athletic events, etc...
- Access to \$100 emergency student loans
- Admittance for you and your guests to a free brunch the day of graduation
- Membership in ASO clubs
- The opportunity to be part of an organized voice for your student government

All this and more for only \$7 per semester! For more information or to sign up, visit the ASO Student Office in C-105.

2010-2011 GRADUATION PLAN "A" STUDENT PROGRAM ADVISEMENT WORKSHEET for the Associate in Arts or Associate in Science Degree

Student's Name: _____
 (Please print) **Last** _____ **First** _____ **Middle** _____ **SSN (or student ID#)** _____

Units Requirement: 60 to 64 units of course credit in a related curriculum.

Major Requirement: At least 18 semester units of study taken in a single discipline or related disciplines.

Scholarship Requirement: A "C" (2.0) grade average or better in all college work attempted in the curriculum upon which the degree is based.

General Education Requirements: Successful completion of at least 30 semester units of general education as indicated in the areas below.

Students who are interested in transferring to a four-year college or university should visit the University Transfer Center, ST-203 or consult with a counselor regarding which courses can transfer.

	Units comp	Units in progress	Units needed	Equiv. courses other CC's		Units comp	Units in progress	Units needed	Equiv. courses other CC's	
A. NATURAL SCIENCES <i>(3 units minimum)</i> Anthropology 101 Astronomy 1, 2, 5 Biology 3, 6, 7, 20, 36 Chemistry 40, 51, 65, 70, 101, 102, 211, 212, 221 Chemical Technology 111, 121 Electronics 2 Environmental Science 1 Geography 1 Geology 1, 6 Microbiology 1, 20 Physical Science 1, 14 Physics 1, 2, 3, 4, 6, 7, 11, 12, 14 [†] , 29 [†] , 32 [†] Psychology 2					D. LANGUAGE & RATIONALITY <i>(12 units minimum)</i> 1. English Composition/English Competency Requirement <i>Completion of one of the following courses (or its equivalent at another college) with a grade of "C" or better</i> English 101 2. Communication & Analytical Thinking <i>Select two courses from the list below. To meet the mathematics competency, complete at least one course listed in Section a below (or its equivalent at another college) must be completed with a grade of "C" or better OR Achievement of a score of 15 or higher on the District Mathematics Competency Examination</i> a. Math 125 (Elective only Math 114 & 115) **Statistics 1 **Computer Technology 60 **Electronics 10, 12, 14 **General Engineering Technology 121 **Engineering Technology 49, 50, 51 b. Computer Information Systems 701 English 103 Philosophy 6, 8 Speech 101, 103, 104, 151 3. Select an additional course from D1 or D2 above					
B. SOCIAL & BEHAVIORAL SCIENCES <i>(9 units minimum)</i> 1. American Institutions & U.S. History History 11, 12, 13, 41, 42, 43, 44, 52, <i>or</i> Political Science 1 <i>or</i> Labor Studies 4 <i>Students can elect to take a competency exam. The exam is available upon request from the Social Science Department, room F-225, (213) 763-3938</i> 2. Social Sciences (Select one course from the list below): Anthropology 102, 109, 121 Business 1, 5 Child Development 1, 2, 3, 11, 42 Economics 1, 2 Geography 2 History 86, 87 Political Science 2, 7 Psychology 1, 11, 17, 32, 41, 69 Sociology 1, 2, 28 Speech Communication 121, 122, 122H 3. One additional course from B1 <i>or</i> B2 above					E. HEALTH & PHYSICAL EDUCATION <i>(3 units minimum)</i> Select one option 1. Health 2 or 6 (meets both Physical Education & Health requirements) 2. 1 unit of P.E. and choose one from Health 8, 11, 12, 21, 31, 32, 33, 35, 41, 42, 44, 45, 46, 47, 50, 51, or 52					
C. HUMANITIES <i>(3 units minimum)</i> American Sign Language 1, 2 Arabic 1 Architecture 130 [†] , 131 [†] Art 101, 102, 103, 104, 201, 202, 300, 501, 502 Chinese 1, 2 English 102, 203, 205, 205H, 206, 206H, 207, 208, 212, 212H, 213, 215, 215H, 218, 219, 220, 220H, 234, 240, 270 French 1, 2, 3, 21 Humanities 1, 2, 54, 60, 61, 73 Japanese 1, 21, 22 Journalism 105 Labor Studies 21 Music 101, 141, 142 Philosophy 1 Physical Education 750, 761, 762, 800 Spanish 1, 2, 3, 4, 21, 22, 35, 36 Speech 130 Theater 100, 210, 507 Visual Communications 106 [†] , 108 [†] , 120 [†] , 130 [†]					TOTAL Note: Nursing students are exempted from the Health requirement. Persons requiring exemption from physical Education for medical purposes or extenuating circumstances must file a general petition in the Office of Admissions & Records, ST-Lobby <i>Students who take and pass competency examinations are awarded competency credit but no unit credit.</i> [†] This course alone will not meet the unit requirement to fulfill the category. **These courses are not offered at Trade-Tech but may have been taken at another college in the Los Angeles Community College District					

You must apply for graduation. Forms and instructions are available in the Admissions and Records Office, Student Services Building, ST-Lobby.

Counselor's Signature _____

Date _____

2010-2011 GRADUATION PLAN "B" STUDENT PROGRAM ADVISEMENT WORKSHEET for the Associate in Arts or Associate in Science Degree

Student's Name: _____
(Please print) Last First Middle SSN (or student ID#)

Units Requirement: 60 to 64 units of course credit in a selected curriculum.

Major Requirement: At least 36 semester units of study taken in a single discipline or related disciplines.

Scholarship Requirement: A "C" (2.0) grade average or better in all college work attempted in the curriculum upon which the degree is based.

General Education Requirements: Successful completion of at least 18 semester units of general education as indicated in the areas below.

Students who are interested in transferring to a four-year college or university should visit the University Transfer Center, ST-203, or consult with a counselor regarding which courses can transfer.

GRADUATION & TRANSFER

	Units comp	Units in progress	Units needed	Equiv. courses other CC's		Units comp	Units in progress	Units needed	Equiv. courses other CC's
A. NATURAL SCIENCES (3 units minimum) Anthropology 101 Astronomy 1, 2, 5 Biology 3, 6, 7, 20, 36 Chemistry 40, 51, 65, 70, 101, 102, 211, 212, 221 Chemical Technology 111, 121 Electronics 2 Environmental Science 1 Geography 1 Geology 1, 6 Microbiology 1, 20 Physical Science 1, 14 Physics 1, 2, 3, 4, 6, 7, 11, 12, 14, 29, 32 Psychology 2					D. LANGUAGE & RATIONALITY (6 units minimum) 1. English Composition/English Competency Requirement Completion of one of the following courses (or its equivalent at another college) with a grade of "C" or better English 101 2. Communication & Analytical Thinking To meet the mathematics competency, complete at least one course listed in Section a below (or its equivalent at another college) must be completed with a grade of "C" or better OR Achievement of a score of 15 or higher on the District Mathematics Competency Examination a. Math 125 **Statistics 1 **Computer Technology 60 **Electronics 10, 12, 14 **General Engineering Technology 121 **Engineering Technology 49, 50, 51 Select 3 units from the following courses only if competency exam was taken and passed b. Computer Information Systems 701 English 103 Philosophy 6, 8 Speech 101, 103, 104, 151				
B. SOCIAL & BEHAVIORAL SCIENCES (3 units minimum) 1. American Institutions & U.S. History History 11, 12, 13, 41, 42, 43, 44, 52, or Political Science 1 or Labor Studies 4 Students can elect to take a competency exam. The exam is available upon request from the Social Science Dept., room F-225, (213) 763-3938 2. Social Sciences Select 3 units from the following courses only if competency exam was taken and passed Anthropology 102, 109, 121 Business 1, 5 Child Development 1, 2, 3, 11, 42 Economics 1, 2 Geography 2 History 86, 87 Political Science 2, 7 Psychology 1, 11, 17, 32, 41, 69 Sociology 1, 2, 28 Speech Communications 121, 122, 122H					E. HEALTH & PHYSICAL EDUCATION (3 units minimum) Select one option 1. Health 2 or 6 (meets both Physical Education & Health requirements) 2. 1 unit of P.E. and choose one from Health 8, 11, 12, 21, 31, 32, 33, 35, 41, 42, 44, 45, 46, 47, 50, 51, or 52 TOTAL				
C. HUMANITIES (3 units minimum) American Sign Language 1, 2 Arabic 1 Architecture 130, 131 ¹ Art 101, 102, 103, 104, 201, 202, 300, 501, 502 Chinese 1, 2 English 102, 203, 205, 205H, 206, 206H, 207, 208, 212, 212H, 213, 215, 218, 219, 220, 220H, 234, 240, 270 French 1, 2, 3, 21 Humanities 1, 2, 54, 60, 61, 73 Japanese 1, 21, 22 Journalism 105 Labor Studies 21 Music 101, 141, 142 Philosophy 1 Physical Education 750, 761, 762, 800 Spanish 1, 2, 3, 4, 21, 22, 35, 36 Speech 130 Theater 100, 210, 507 Visual Communications 106 ¹ , 108 ¹ , 120 ¹ , 130 ¹					Note: Nursing students are exempted from the Health requirement. Persons requiring exemption from physical Education for medical purposes or extenuating circumstances must file a general petition in the Office of Admissions & Records, ST-Lobby. Students who take and pass competency examinations are awarded competency credit but no unit credit. ¹ This course alone will not meet the unit requirement to fulfill the category. **These courses are not offered at Trade-Tech but may have been taken at another college in the Los Angeles Community College District				

You must apply for graduation. Forms and instructions are available in the Admissions and Records Office, Student Services Building, ST-Lobby.

Counselor's Signature _____

Date _____

2010Apr15

2010-2011 CALIFORNIA STATE UNIVERSITY GENERAL EDUCATION CHECK SHEET

Student's Name: _____
 (Please print) Last First Middle SSN (or student ID#)

Title 5 of the Administrative Code allows Los Angeles Trade-Technical College to specify a pattern of General Education courses which are acceptable to meet the General Education requirements at any of the California State Universities and Colleges. **UNITS IN AREA A AND B3 MUST BE COMPLETED WITH A "C" OR BETTER AND ARE REQUIRED FOR ADMISSION.** Students must maintain an overall grade point average of "C" or better in all courses. *Certification of these units is not automatic and must be requested.* Students must see a counselor to have records evaluated for certification. Each area, A through E, may be certified individually when completed. Course may be used in only one area.

A student who does not meet certification requirement will be evaluated by the State University and may be required to complete additional the General Education courses.

Lower Division Major Requirements: In addition to the General Education pattern, students transferring to the CSU may complete Lower Division Major Requirements at LATIC. Visit the University Transfer Center, ST-203 or consult with a counselor for a list of these courses.

(Students must complete a minimum of 60 semester units of transferable credit unless they were eligible to be admitted as freshmen.)

CSU Certification Requirements	Units comp	Units in progress	Units needed	Equiv. courses other CC's	CSU Certification Requirements	Units comp	Units in progress	Units needed	Equiv. courses other CC's	
A. COMMUNICATION & CRITICAL THINKING (9 units minimum) Select one course from each of A1, A2, & A3 A1. Oral Communication: Speech 101, 103, 151 A2. Written Communication: English 101, 101H A3. Critical Thinking: English 102, 103; Philosophy 6, 8; Speech 104					D. SOCIAL, POLITICAL AND ECONOMIC INSTITUTIONS AND BEHAVIOR; HISTORICAL BACKGROUND (9 units minimum) Select one course from D6, one from D8, and a third course from another D1-D10 category. Note: Courses which may be used to satisfy American Institutions at CSU are denoted by (‡) and include Political Science 1 with a U.S. History Class (History 11, 12, 13, 41, 42, 43). D0. Sociology Sociology 1, 2 D1. Anthropology: Anthropology 102, 109, 121 D2. Economics: Economics 1, 2 Labor Studies 8 D3. Ethnic Studies Speech 122, 122H D4. Gender Studies Anthropology 109 History 52 Psychology 32 D5. Geography Geography 2 D6. History: History 1‡, 12‡, 13‡, 41‡, 42‡, 43‡, 44, 52, 86, 87 Labor Studies 1 D7. Interdisciplinary: Labor Studies 4 Speech 122, 122H D8. Political Science: Political Science 1‡, 2, 7 D9. Psychology: Child Development 1 Psychology 1, 11, 32					
B. PHYSICAL UNIVERSE & ITS LIFE FORMS (9 units minimum) Select one course from each of B1, B2, and B3: At least one course must have a laboratory. Laboratory courses are marked with an asterisk (*) B1. Physical Science Astronomy 1, 2*, 5* Chemistry 51*, 65*, 70*, 70H, 101*, 101H, 102*, 102H, 211*, 211H, 212*, 212H, 221*, 221H Geography 1 Geology 1, 6* Physical Science 1, 14* Physics 1*, 2*, 3*, 4*, 6*, 7*, 11*, 12, 14* B2. Life Science Anthropology 101 Biology 3*, 6*, 7*, 20* Microbiology 1*, 20* B3. Mathematical/Quantitative: Mathematics 225, 227, 230, 235, 236, 240, 245, 260, 265, 266, 267, 270, 275										
C. ARTS, LITERATURE, PHILOSOPHY AND FOREIGN LANGUAGE (9 units minimum) Select at least one course from C1, one from C2, and a third course from C1 or C2 C1. Arts Architecture 130‡, 131‡ <i>‡ 2 units only</i> Art 101, 102, 103, 104, 201, 202, 501 Music 101, 141, 141H, 142, 142H Physical Education 800 Theater Arts 100, 507 C2. Humanities American Sign Language 1, 2 English 102, 203, 205, 205H, 206, 206H, 207, 208, 212, 212H, 213, 215, 215H, 219, 220, 220H, 234, 240, 270 French 1, 2, 3 History 52 Humanities 1, 2, 60, 61, 73 Japanese 1, 21 Labor Studies 21 Philosophy 1 Physical Education 750 Spanish 1, 2, 3, 4, 21, 22, 35, 36 Speech 130						E. LIFELONG UNDERSTANDING AND SELF-DEVELOPMENT (3 units minimum) Select one course Health 2, 6, 8, 11, 21, 52 Psychology 41				
						TOTAL				
						Certification of these units is not automatic and must be requested. First, see a counselor to have records evaluated for certification. Counselors forward completed certification form to Admissions Office Evaluation Technicians. Coursework from other colleges or universities must be on file (official transcript) in the Admission Office.				
						_____ [] Fully Certified [] Partially Certified Catalog Year				
						_____ / _____ Counselor's Signature/Date Evaluation Technician's Signature/Date				

GRADUATION & TRANSFER

2010-2011 UC/CSU – IGETC GENERAL EDUCATION CHECK SHEET

Student's Name:

(Please print) Last First Middle SSN (or student ID#)

The Intersegmental General Education Transfer Curriculum (IGETC) is a series of courses that community college students can use to satisfy lower division general education requirements at any CSU or UC campus. The IGETC provides an option to the California State University General Education Requirements. Students in high unit majors are encouraged to follow a particular UC campus' breadth requirements instead of the IGETC. See a counselor for additional information. **IMPORTANT:** The IGETC must be certified prior to transfer! If not certified, a student will be required to complete the four-year university's own general education/breadth requirements and additional lower-division coursework may be required. All courses must be completed with "C" grade or higher. (See your counselor for certification)

GRADUATION & TRANSFER

LEGEND: C = Completed IP = In Progress or AP Exam	EC = Equivalent Course R = Remaining	Units comp	Units in progress	Units needed	Equiv. courses other CC's	LEGEND: C = Completed IP = In Progress or AP Exam	EC = Equivalent Course R = Remaining	Units comp	Units in progress	Units needed	Equiv. courses other CC's
AREA 1 - ENGLISH COMMUNICATION CSU - 3 courses required, one from each group below, 9 semester units UC - 2 courses required, one each from Group A and B, 6 semester units Group A: English Composition (1 course, 3 semester units) English 101, 101H Group B: Critical Thinking - English Composition (1 course, 3 semester units) English 102, 103 Group C: Oral Communication (CSU only) (1 course, 3 semester units) Speech 101, 104, 151						AREA 4 - SOCIAL AND BEHAVIORAL SCIENCES (at least 3 courses, 9 semester units) At least three from two disciplines or an interdisciplinary sequence. Anthropology 102, 109, 121 Child Development 1 Economics 1, 2 Geography 2 History 11*, 12*, 13*, 41*, 42*, 43*, 44, 52**, 86, 87 Labor Studies 8 Political Science 1**, 2, 7 Psychology 1, 11, 32 Sociology 1, 2 Speech 122, 122H					
AREA 2 - MATHEMATICAL CONCEPTS AND QUANTITATIVE REASONING (1 course, 3 semester units) Math 225, 227, 235*, 236*, 245, 260, 265*, 266*, 267, 270, 275						AREA 5 - PHYSICAL AND BIOLOGICAL SCIENCES (at least 2 course, 7-9 semester units) One Physical Science course and one Biological Science course; at least one must include a laboratory (indicated by "L" in parentheses). PHYSICAL SCIENCES Astronomy 1*, 2*(L) or 5(L) Chemistry 51*(L), 65*(L), 70*(L), 101(L), 102(L), 211(L), 212(L), 221(L) Geography 1 Geology 1 Physics 1*(L), 2*(L), 3*(L), 4*(L), 6*(L), 7*(L), 11*(L), 12*, 14*(L) BIOLOGICAL SCIENCES Anthropology 101 Biology 3*(L), 6(L), 7(L), 20(L) Microbiology 1*(L), 20*(L)					
AREA 3 - ART AND HUMANITIES (at least 3 courses, 9 semester units) At least one course from Arts, one from Humanities, and a third course from Arts or Humanities Arts Courses Art 101, 102 103, 104 Music 101, 142 Physical Education 800 Theater 100, 507 Humanities Courses American Sign Language 2 English 102, 203, 205, 205H, 206, 206H, 207, 208, 212, 212H, 213, 215, 215H, 219, 220, 220H, 234, 240, 270 French 2, 3 History 52** Humanities 1, 2*, 60 Japanese 2 Labor Studies 21 Philosophy 1 Spanish 2, 3, 4 Theater 100**, 507**						FOREIGN LANGUAGE (UC requirement only) Proficiency equivalent to two years of high school study in the same language. American Sign Language 1, 2** Arabic 1 Chinese 1, 2 French 1, 2**, 3** Japanese 1, 2**, 22 Spanish 1, 2**, 3**, 4**, 21, 22, 35, 36 Completed at high school					
*Indicates that transfer credit may be limited by either UC or CSU or both. Please consult with a counselor for additional information. **Course may be listed in more than one area, but shall not be certified in more than one area.						TOTAL					

Certification of these units is not automatic and must be requested. First, see a counselor to have records evaluated for certification. Coursework from other colleges or universities must be on file (official transcript) in the Admission Office.

CSU GRADUATION REQUIREMENT IN AMERICAN INSTITUTIONS 6 units, one course from (a) and one course from (b) (a) Political Science 1 (b) History 11, 12, 13					
Note: Courses used to meet this requirement may not be used to satisfy requirements for IGETC					

_____ Counselor (Print Name)	_____ Signature	_____ Date
_____ Evaluation Technician (Print Name)	_____ Signature	_____ Date

Full IGETC Certification

Partial IGETC Certification

_____ Units Needed

EDUCATIONAL PROGRAMS

Los Angeles Trade-Technical College has approval from the District Board of Trustees and the State Chancellor's Office to offer the following occupational programs and to grant the degrees and/or certificates as indicated.

Major Code		Degree	Certificate	Major Code		Degree	Certificate
0201.00	Architectural Technology	•	•	0934.23	• Programmable Logic Controllers		
0201.02	• Computer Aided Drafting			0934.21	• Voice Data Video and Fire Life Safety Technician		
0299.00	• Digital Design			0952.22	• Motor Control		
0299.01	• Historic Preservation			0934.01	Electronics Communication	•	•
2206.11	• Community GIS Mapping			0934.17	• Advanced Electronics Assembly and Repair		
0299.00	• M.A.P./S/G.I.S		•	0934.25	• Basic Electronics Assembly and Repair		
0948.20	Automotive Collision Repair	•	•	0934.18	• Digital Circuits Technician		
0948.00	Automotive And Related Technology	•	•	0934.31	• Electronics Communications Technician		
0948.00	• Engine Performance			0999.02	• Robotics		
0948.01	• Transmission Repair			0934.27	• Semiconductor Devices Technician		
0948.02	• Mechanical Repair			0934.35	• Telecommunication Field Technician		
0948.04	• Brake Suspension and Steering Technology			0709.05	• IT Security Specialist - Level I		
1306.32	Baking, Professional	•	•	0708.11	• CIS/Linux Networking Certificate		
	Business			0934.81	• Fiber Optics Network Cabling Specialist		
0502.00	• Accounting	•	•	0999.01	• Soldering Surface Mount Technology		
0502.01	• Accounting Clerk		•	1501.00	English	•	
0502.05	• Accounting Clerk Assistant			1303.10	Fashion Design	•	•
1499.01	• Bilingual Law Assistant			1303.33	• Apparel Computer Technology		
0509.51	• Customer Service Specialist			1303.11	• Fashion Technology	•	
0506.31	• Governmental Supervision		•	1303.10	Fashion Design-Adjunct		•
0502.12	• Income Tax Preparation Specialist			1303.20	Fashion Merchandising	•	•
0506.01	• Management/Supervision	•	•	1303.22	• Fashion Promotion		
0509.50	• Marketing and Public Relations	•	•	1303.21	• Retail Fashion Management		
0502.04	• Payroll Specialist			0516.00	Labor Studies	•	•
0506.03	• Project Management Specialist			4901.00	Liberal Arts	•	
0511.00	• Real Estate	•	•	0956.31	Machine Shop CNC	•	•
0509.51	• Retail Merchandising	•		0956.32	Machine Shop CNC - Adjunct	•	•
0509.52	• Sales and Marketing Specialist			0934.02	Microcomputer Technician I.T. Essentials	•	•
0709.01	• Website Development & Maintenance Assistant/Small Bus			0708.18	• A + Microcomputer Technician		
0506.02	• Small Business Entrepreneurship		•	0504.00	Mortgage Finance – Plan A	•	
0952.50	Cabinetmaking and Millwork	•	•	0504.00	Mortgage Finance – Plan B	•	•
0951.51	Construction Technologies	•	•	0504.04	• Mortgage Loan Officer		
0952.10	Carpentry	•	•	0504.03	• Financial/Home Ownership Counselor		
0952.11	Carpentry: Construction Technologies	•	•	0504.01	• Bank Teller		
0955.00	Chemical Technology	•	•	0948.31	Motorcycle Repair Mechanics		•
0954.01	• Process Plant Technology			0945.13	Operation and Maintenance Engineering		•
0958.01	• Solid Waste Management Technology		•	1203.00	Nursing, Registered	•	
1305.10	Child Development - Plan A	•		1302.20	Nursing, Vocational	•	•
1305.11	Child Development - Plan B	•		1230.35	• Certified Nurse Assistant (C.N.A.)		
1305.15	• Center Director			1230.81	• Home Health Aide (HHA)		
1305.16	• Infant Care Teacher				Physical Education		
1305.12	• Preschool Teacher		•	0835.71	• Aquatics		
1305.14	• Preschool Teacher Assistant			0835.61	• Coaching		
1305.17	• School Age Programs Teacher/Daycare			1305.52	• Elementary Movement Education/Playground		
2102.01	Community Planning and Economic Development	•	•	0835.81	• Fitness for Special Population		
0506.01	• Nonprofit Executive Management			0835.10	• Dance, Beginning		
2102.03	• Community Safety Specialist			0835.11	• Dance, Advanced		
0511.03	• Urban Real Estate Development			0952.30	Plumbing	•	•
2102.01	• Neighborhood Emergency Preparedness Specialist			0952.31	Plumbing: Construction Technologies	•	•
0511.01	• Apartment Management			0958.00	Process Technology	•	•
	Computer Applications and Office Technologies			0945.11	Refrigeration and Air Conditioning Mechanics-AA	•	•
0514.00	• Administrative Assistant	•	•	0945.10	Refrigeration and Air Conditioning Mechanics-AS	•	•
0514.03	• General Office Assistant			0946.11	• Fundamentals of Refrigeration & Air Conditioning		
0514.02	• Information Processing Specialist	•	•	1306.11	Restaurant Management	•	•
1402.03	• Legal Office Assistant			1013.01	Sign Graphics	•	•
0514.21	• Medical Office Assistant	•	•	0999.01	Street Maintenance Technology	•	•
0514.01	• Office Assistant-Clerical	•	•	1303.32	Tailoring-Adjunct	•	•
0701.00	Computer Information Systems	•	•	1013.00	Visual Communications	•	•
3007.00	Cosmetology	•	•	0958.00	Water Systems Technology	•	
1306.30	Culinary Arts	•	•	0958.02	• Supply Water Technology		•
1306.30	• Baking, Professional	•	•	0958.03	• Wastewater Technology		•
1306.31	• Resturant & Food Services Management	•	•	0958.40	• Solid Waste Management Technology		•
0947.00	Diesel and Related Technology	•	•	0956.51	Welding Gas and Electric	•	•
0952.24	Electrical Construction and Maintenance	•	•	0956.51	Welding Gas and Electric: Construction Technologies	•	•
0935.01	• Basic Electrician Trainee			1002.21	• Metal Sculpture		•
0935.01	• National Electrical Code						



FALL 2010 SCHEDULE OF CLASSES

How to read the schedule of classes:

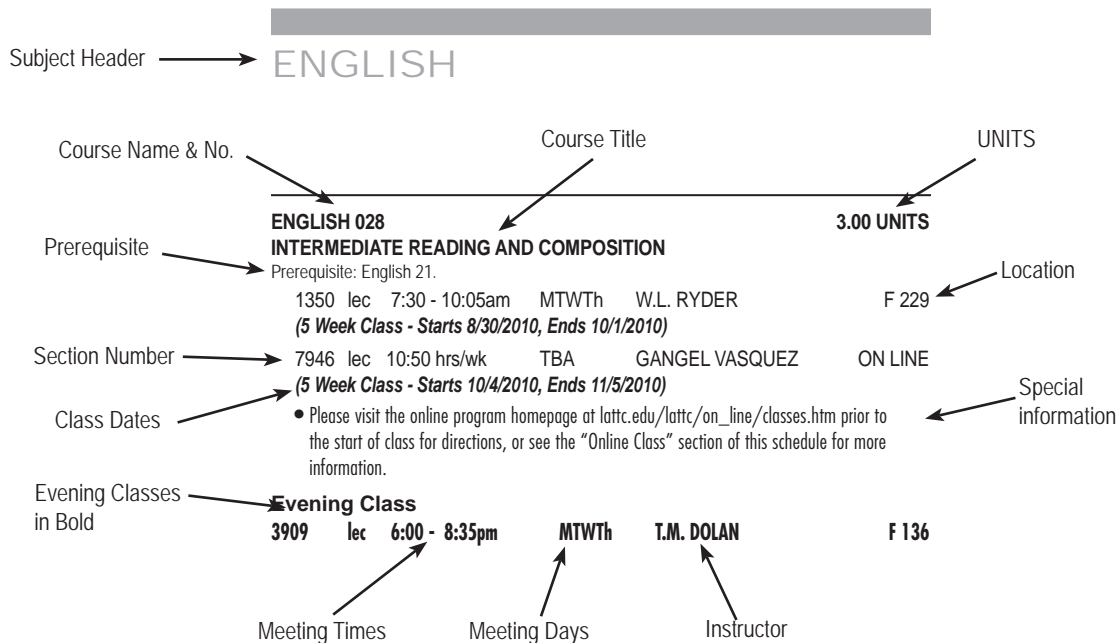

Notes:

1. Bold face type denotes Evening Classes
2. Building and Room Number (If an address is given instead of a regular building and room number, the class is an off-campus class meeting at the address shown.)
3. TBA - To Be Arranged
4. "RPT" followed by a number shows the number of times that a class may be repeated for credit.
5. HRS - Hours per week
6. Lab - Laboratory
7. Lec - Lecture

Course Descriptions:

1. UC - this course is acceptable for unit credit at all branches of the University of California.
2. CSU - this course is acceptable for credit at all branches of the California State universities and colleges.
3. NDA - (Non Degree Applicable)—this course is offered for college credit but cannot be applied toward graduation requirements for the associate degree.



Notice of Room Changes

Trade-Tech will be undergoing construction throughout the 2010-11 school year and classroom locations are subject to change after the printing of this schedule. Please check the college website for updates on individual class locations by logging onto the LATTC.edu website, then going to "Schedule of Classes" and following the individual links. Thank you for your patience during this process.

ACCOUNTING

ACCOUNTING 001 INTRODUCTORY ACCOUNTING I (UC:CSU) 5.00 UNITS

Recommended Preparation: Business 38.

0101 lec 8:35am - 9:50am MTWTh STAFF K 324

Evening Class

3004 lec 5:30pm - 8:30pm T C.R. MONTOUR K 208
& lec 2:30 hrs/wk TBA C.R. MONTOUR ON LINE

• Please visit the online program homepage at <http://moodle.lattc.edu> prior to the start of class for directions, or see pages 82-84 of this schedule for more information.

ACCOUNTING 002 INTRODUCTORY ACCOUNTING II (UC:CSU) 5.00 UNITS

Evening Class

3005 lec 5:30pm - 9:00pm W C.R. MONTOUR K 208
& lec 1:30 hrs/wk TBA - C.R. MONTOUR K 208

ACCOUNTING 003 INTERMEDIATE ACCOUNTING I (CSU) 3.00 UNITS

Evening Class

3006 lec 6:00pm - 9:10pm M STAFF K 208

ACCOUNTING 015 TAX ACCOUNTING I (CSU) 3.00 UNITS

Evening Class

3010 lec 6:00pm - 9:10pm Th R.L. GONZALEZ K 324

ACCOUNTING 018 COMPUTERIZED PAYROLL ACCOUNTING 3.00 UNITS

0104 lec 1:00pm - 3:05pm S R.A. JOHNSON K 304
& lab 3:05pm - 5:15pm S R.A. JOHNSON K 304

ACCOUNTING 021 BOOKKEEPING AND ACCOUNTING I (UC:CSU) 3.00 UNITS

0105 lec 8:35am - 9:50am MTWTh STAFF K 324
(11 Week Class - Starts 8/30/2010, Ends 11/11/2010)

ADMINISTRATION OF JUSTICE

ADMINISTRATION OF JUSTICE 002 CONCEPTS OF CRIMINAL LAW (UC:CSU) 3.00 UNITS

6831 lec 8:40am - 11:50am S D. JACKSON HPK HS

• 6020 Miles Ave., Los Angeles, CA 90255

7878 lec 3:30 hrs/wk TBA - W.D. ELARTON ON LINE

• Please visit the online program homepage at <http://moodle.lattc.edu> prior to the start of class for directions, or see pages 82-84 of this schedule for more information.

ADMINISTRATION OF JUSTICE 003 LEGAL ASPECTS OF EVIDENCE (CSU) 3.00 UNITS

8316 lec 12:00pm - 3:10pm S D. JACKSON HPK HS

• 6020 Miles Ave., Los Angeles, CA 90255

AMERICAN SIGN LANGUAGE

AMERICAN SIGN LANGUAGE 001 AMERICAN SIGN LANGUAGE I (UC:CSU) 4.00 UNITS

0760 lec 8:00am - 10:05am TTh S. CORNEAL H 353

0761 lec 8:00am - 10:05am MW J.H. WONG H 353

Evening Class

3500 lec 4:30pm - 6:30pm MW V.M. ANDERSON H 353

AMERICAN SIGN LANGUAGE 002 AMERICAN SIGN LANGUAGE II (UC:CSU) 4.00 UNITS

Prerequisite: American Sign Language I.

0762 lec 8:00am - 10:05am MW A.C. NATALE H 352

ANTHROPOLOGY

ANTHROPOLOGY 101 HUMAN BIOLOGICAL EVOLUTION (UC:CSU) 3.00 UNITS

1000 lec 8:35am - 10:00am MW P.J. HULD TE 315

1002 lec 11:45am - 1:10pm MW P.J. HULD TE 315

1004 lec 10:10am - 11:35am TTh P.J. HULD TE 315

1168 lec 10:10am - 11:35am TTh P.J. HULD TE 315

7971 lec 3:30 hrs/wk TBA - P.J. HULD ON LINE

• Please visit the online program homepage at <http://moodle.lattc.edu> prior to the start of class for directions, or see pages 82-84 of this schedule for more information.

Evening Class

3601 lec 6:00pm - 9:10pm W M.J. CARTER TE 315

ANTHROPOLOGY 102 HUMAN WAYS OF LIFE: CULTURAL ANTHROPOLOGY (UC:CSU) 3.00 UNITS

1005 lec 10:10am - 11:35am MW P.J. HULD TE 315

1006 lec 8:35am - 10:00am TTh P.J. HULD TE 315

1169 lec 8:35am - 10:00am TTh P.J. HULD TE 315

• Section #1169 - Honor Class

ARCHITECTURE

ARCHITECTURE 130 HISTORY OF ARCHITECTURE I (UC:CSU) 2.00 UNITS

8021 lec 7:00am - 9:05am F J. LEWIS D 325

ARCHITECTURE 152 EQUIPMENT OF BUILDINGS (CSU) 3.00 UNITS

8041 lec 7:00am - 8:05am TTh M. OLIVA D 330

& lab 8:05am - 9:25am TTh M. OLIVA D 330

ARCHITECTURE 172
ARCHITECTURAL DRAWING I (CSU) **3.00 UNITS**

8036	lec	7:00am - 8:05am	MW	M. OLIVA	D 331
&	lab	8:05am - 9:35am	MW	M. OLIVA	D 331

ARCHITECTURE 201
ARCHITECTURAL DESIGN I (UC:CSU) **3.00 UNITS**

8042	lec	9:45am - 10:50am	MW	M. OLIVA	D 302
&	lab	10:50am - 12:20pm	MW	M. OLIVA	D 302

ARCHITECTURE 202
ARCHITECTURAL DESIGN II (UC:CSU) **3.00 UNITS**

8043	lec	9:45am - 10:50am	MW	M. OLIVA	D 302
&	lab	10:50am - 12:20pm	MW	M. OLIVA	D 302

ARCHITECTURE 261
COMPUTER-AIDED DESIGN FOR ARCHITECTURE I (CSU) **3.00 UNITS**

8024	lec	9:45am - 10:50am	MW	STAFF	D 302
&	lab	10:50am - 12:20pm	MW	STAFF	D 302

ARCHITECTURE 271
ARCHITECTURAL DRAWING III (CSU) **3.00 UNITS**

8040	lec	7:00am - 8:05am	MW	M. OLIVA	D 331
&	lab	8:05am - 9:35am	MW	M. OLIVA	D 331

ARCHITECTURE 341
GIS METROPOLITAN ACCESS PLANNING SYSTEMS I (CSU) **3.00 UNITS**

8032	lec	8:00am - 9:40am	S	M. OLIVA	D 331
&	lab	9:40am - 2:30pm	S	M. OLIVA	D 331

ARCHITECTURE 342
GIS METROPOLITAN ACCESS PLANNING SYSTEMS II (CSU) **3.00 UNITS**

8033	lec	8:00am - 9:40am	S	M. OLIVA	D 330
&	lab	9:40am - 2:30pm	S	M. OLIVA	D 330

ARCHITECTURE 200
RESIDENTIAL PLANNING (CSU) **3.00 UNITS**

8039	lec	7:00am - 8:05am	TTh	STAFF	D 330
&	lab	8:05am - 9:35am	TTh	STAFF	D 330

ART

ART 101
SURVEY OF ART HISTORY I (UC:CSU) **3.00 UNITS**

Western art from prehistoric times through the Renaissance.

1340	lec	7:00am - 8:25am	MW	P.J. HERBERT	H 224
1341	lec	10:10am - 11:35am	MW	P.J. HERBERT	H 224
1342	lec	11:45am - 1:10pm	MW	P.J. HERBERT	H 224
1584	lec	7:00am - 8:25am	MW	P.J. HERBERT	H 224

- Section #1584 - Honor Class.

7940	lec	3:25 hrs/wk TBA	-	G.J. SZYMANSKI	ON LINE
------	-----	-----------------	---	----------------	---------

- Please visit the online program homepage at <http://moodle.lattc.edu> prior to the start of class for directions, or see pages 82-84 of this schedule for more information.

7944	lec	3:25 hrs/wk TBA	-	A. MALONE	ON LINE
------	-----	-----------------	---	-----------	---------

(10 Week Class - Starts 10/11/2010, Ends 12/19/2010)

- Please visit the online program homepage at <http://moodle.lattc.edu> prior to the start of class for directions, or see pages 82-84 of this schedule for more information.

Evening Classes

3825	lec	6:00pm - 9:10pm	Th	C.D. PARKER	F 229
3838	lec	6:00pm - 9:10pm	MW	STAFF	F 223

(8 Week Class - Starts 10/25/2010, Ends 12/16/2010)

ART 102
SURVEY OF ART HISTORY II (UC:CSU) **3.00 UNITS**

Western art from early Renaissance to the present.

1343	lec	8:35am - 10:00am	MW	P.J. HERBERT	H 224
------	-----	------------------	----	--------------	-------

ART 103
ART APPRECIATION I (UC:CSU) **3.00 UNITS**

1345	lec	10:10am - 11:35am	TTh	G.J. SZYMANSKI	H 236
------	-----	-------------------	-----	----------------	-------

ART 104
ART APPRECIATION II (UC:CSU) **3.00 UNITS**

7942	lec	3:25 hrs/wk TBA	-	A. MALONE	ON LINE
------	-----	-----------------	---	-----------	---------

- Please visit the online program homepage at <http://moodle.lattc.edu> prior to the start of class for directions, or see pages 82-84 of this schedule for more information.

ART 201
DRAWING I (UC:CSU) **3.00 UNITS**

Pencil, charcoals, pastel and other drawing media.

1347	lec	8:00am - 9:05am	TTh	P.J. HERBERT	H 224
&	lab	9:05am - 10:05am	TTh	P.J. HERBERT	H 224
1348	lec	12:30pm - 1:35pm	MW	G.J. SZYMANSKI	H 236
&	lab	1:35pm - 2:35pm	MW	G.J. SZYMANSKI	H 236
1358	lec	10:10am - 11:15am	MW	G.J. SZYMANSKI	H 236
&	lab	11:15am - 12:15pm	MW	G.J. SZYMANSKI	H 236
1375	lec	8:30am - 10:50am	S	A. MANN	H 334
&	lab	10:50am - 1:45pm	S	A. MANN	H 334

(13 Week Class - Starts 9/18/2010, Ends 12/19/2010)

Evening Class

3826	lec	6:00pm - 8:05pm	T	F.J. WILLIAMS	H 236
&	lab	8:05pm - 10:10pm	T	F.J. WILLIAMS	H 236

ART 202
DRAWING II (UC:CSU) **3.00 UNITS**

Continuation of Art 201.

1349	lec	8:00am - 9:05am	TTh	P.J. HERBERT	H 224
&	lab	9:05am - 10:05am	TTh	P.J. HERBERT	H 224
1350	lec	12:30pm - 1:35pm	MW	G.J. SZYMANSKI	H 236
&	lab	1:35pm - 2:35pm	MW	G.J. SZYMANSKI	H 236
1365	lec	10:10am - 11:15am	MW	G.J. SZYMANSKI	H 236
&	lab	11:15am - 12:15pm	MW	G.J. SZYMANSKI	H 236

Evening Class

3828	lec	6:00pm - 8:05pm	T	F.J. WILLIAMS	H 236
&	lab	8:05pm - 10:10pm	T	F.J. WILLIAMS	H 236

ART 300
INTRODUCTION TO PAINTING (UC:CSU) **3.00 UNITS**

Applications of acrylic, oil, and watercolor.

1357	lec	10:10am - 11:15am	TTh	P.J. HERBERT	H 224
&	lab	11:15am - 12:15pm	TTh	P.J. HERBERT	H 224

ART 304 **3.00 UNITS**
ACRYLIC PAINTING I (CSU)

1364	lec	10:10am - 11:15am	TTh	P.J. HERBERT	H 224
&	lab	11:15am - 12:15pm	TTh	P.J. HERBERT	H 224

ART 385 **3.00 UNITS**
DIRECTED STUDY - ART HONORS (CSU)

1355	lec	3:25 hrs/wk TBA	-	P.J. HERBERT	H 224
------	-----	-----------------	---	--------------	-------

ART 501 **3.00 UNITS**
BEGINNING TWO-DIMENSIONAL DESIGN (UC:CSU)

1359	lec	12:20pm - 1:25pm	TTh	G.J. SZYMANSKI	H 236
&	lab	1:25pm - 2:25pm	TTh	G.J. SZYMANSKI	H 236

ART 502 **3.00 UNITS**
BEGINNING THREE-DIMENSIONAL DESIGN (UC:CSU)

1360	lec	12:20pm - 1:25pm	TTh	G.J. SZYMANSKI	H 236
&	lab	1:25pm - 2:25pm	TTh	G.J. SZYMANSKI	H 236

ASTRONOMY

ASTRONOMY 001 **3.00 UNITS**
ELEMENTARY ASTRONOMY (UC:CSU)

1600	lec	7:00am - 8:25am	MW	F.J. PADILLA	K 406
1601	lec	11:45am - 1:10pm	MW	M.A. MORENO	K 420
1602	lec	10:10am - 11:35am	TTh	F.J. PADILLA	K 406

Evening Class

4045	lec	5:00pm - 6:25pm	TTh	M.A. MORENO	USC EART
------	-----	-----------------	-----	-------------	----------

- First Class meeting at Los Angeles Trade Tech College in Room K-420.
- USC - University Park Campus Earth Science, Building B-56. Contact 213-763-7295

ASTRONOMY 005 **1.00 UNIT**
FUNDAMENTALS OF ASTRONOMY LABORATORY (UC:CSU)

1603	lab	7:00am - 10:10am	T	F.J. PADILLA	K 420
------	-----	------------------	---	--------------	-------

Evening Class

4046	lab	7:00pm - 8:25pm	TTh	M.A. MORENO	USC EART
------	-----	-----------------	-----	-------------	----------

- First Class Meeting at Los Angeles Trade Tech College in Room k-420.
- USC - University Park Campus Earth Science, Building B-56. Contact 213-763-7295

AUTOMOTIVE AND RELATED TECHNOLOGY

AUTOMOTIVE AND RELATED TECHNOLOGY 100 **3.00 UNITS**
HEATING AND AIR CONDITIONING SYSTEMS THEORY, INSPECTION & REPAIR**Evening Class**

4382	lec	5:35pm - 6:30pm	TTh	B.A. GOYN	F 128
&	lab	6:30pm - 9:30pm	TTh	B.A. GOYN	F 128

AUTOMOTIVE AND RELATED TECHNOLOGY 112 **3.00 UNITS**
BASIC SHOP PRINCIPLES AND PRACTICES

7490	lec	7:00am - 7:50am	MTWThF	D.A. ENCINAS	F 124
&	lec	7:50am - 12:00pm	MTWThF	D.A. ENCINAS	F 124

(5 Week Class - Starts 8/30/2010, Ends 10/1/2010)

7492	lec	7:00am - 7:50am	MTWThF	D.A. ENCINAS	F 124
&	lec	7:50am - 12:00pm	MTWThF	D.A. ENCINAS	F 124

(6 Week Class - Starts 11/8/2010, Ends 12/16/2010)

AUTOMOTIVE AND RELATED TECHNOLOGY 113A **3.00 UNITS**
DRIVE TRAIN COMPONENTS PRINCIPLES AND PRACTICES

7340	lec	7:00am - 7:45am	MTWThF	J.R. URIBE	F 130
&	lab	7:45am - 12:00pm	MTWThF	J.R. URIBE	F 130

(5 Week Class - Starts 8/30/2010, Ends 10/1/2010)

Evening Class

4381	lec	5:35pm - 6:30pm	MW	R. GUERRA	F 130
&	lab	6:30pm - 9:30pm	MW	R. GUERRA	F 132

AUTOMOTIVE AND RELATED TECHNOLOGY 113B **3.00 UNITS**
DRIVE TRAIN COMPONENTS PRINCIPLES AND PRACTICES

7346	lec	7:00am - 7:50am	MTWThF	D.A. ENCINAS	F 130
&	lab	7:50am - 12:00pm	MTWThF	D.A. ENCINAS	F 130

(5 Week Class - Starts 10/4/2010, Ends 11/5/2010)

AUTOMOTIVE AND RELATED TECHNOLOGY 114A **3.00 UNITS**
STEERING,SUSPENSION,BRAKES,PRINCIPLES AND PRACTICES

7353	lec	7:00am - 7:50am	MTWThF	J.R. URIBE	F 108
&	lab	7:50am - 12:00pm	MTWThF	J.R. URIBE	F 108

(6 Week Class - Starts 11/8/2010, Ends 12/16/2010)

AUTOMOTIVE AND RELATED TECHNOLOGY 114B **3.00 UNITS**
STEERING,SUSPENSION,BRAKES,PRINCIPLES AND PRACTICES

7347	lec	7:00am - 7:50am	MTWThF	J.R. URIBE	F 108
&	lab	7:50am - 12:00pm	MTWThF	J.R. URIBE	F 108

(5 Week Class - Starts 10/4/2010, Ends 11/5/2010)

Evening Class

4380	lec	5:35pm - 6:30pm	MW	J.R. URIBE	F 108
&	lec	6:30pm - 9:30pm	MW	J.R. URIBE	F 108

AUTOMOTIVE AND RELATED TECHNOLOGY 121 **3.00 UNITS**
BASIC ENGINE THEORY INSPECTION AND REPAIR (CSU)

7342	lec	7:00am - 7:50am	MTWThF	T.J. MCFALL	F 122
&	lab	7:50am - 12:00pm	MTWThF	T.J. MCFALL	F 122

(5 Week Class - Starts 8/30/2010, Ends 10/1/2010)

7348	lec	7:00am - 7:50am	MTWThF	T.J. MCFALL	F 122
&	lab	7:50am - 12:00pm	MTWThF	T.J. MCFALL	F 122

(5 Week Class - Starts 10/4/2010, Ends 11/5/2010)

7354	lec	7:00am - 7:50am	MTWThF	T.J. MCFALL	F 122
&	lab	7:50am - 12:00pm	MTWThF	T.J. MCFALL	F 122

(6 Week Class - Starts 11/8/2010, Ends 12/16/2010)

Evening Class

4400	lec	5:35pm - 6:10pm	TTh	R.C. SERRATO	F 132
&	lab	6:10pm - 9:30pm	TTh	R.C. SERRATO	F 106

AUTOMOTIVE AND RELATED TECHNOLOGY 122 **3.00 UNITS**
ELECTRICAL/ELECTRONIC SYSTEMS THEORY, INSPECTION & REPAIR (CSU)

7343	lec	7:00am - 7:50am	MTWThF	W.F. WOO	F 128
&	lab	7:50am - 12:00pm	MTWThF	W.F. WOO	F 128

(5 Week Class - Starts 8/30/2010, Ends 10/1/2010)

7349	lec	7:00am - 7:50am	MTWThF	W.F. WOO	F 128
&	lab	7:50am - 12:00pm	MTWThF	W.F. WOO	F 128

(5 Week Class - Starts 10/4/2010, Ends 11/5/2010)

Evening Class

4384	lec	5:35pm - 6:30pm	MW	W.F. WOO	F 128
&	lab	6:30pm - 9:30pm	MW	W.F. WOO	F 128

**AUTOMOTIVE AND RELATED TECHNOLOGY 123
FUEL & EMISSIONS SYSTEMS THEORY, INSPECTION & REPAIR (CSU)** **3.00 UNITS**

7344	lec	7:00am - 7:50am	MTWThF	M.A. MARROQUIN	F 116
&	lab	7:50am - 12:00pm	MTWThF	M.A. MARROQUIN	F 116

(5 Week Class - Starts 8/30/2010, Ends 10/1/2010)

7350	lec	7:00am - 7:50am	MTWThF	M.A. MARROQUIN	F 116
&	lab	7:50am - 12:00pm	MTWThF	M.A. MARROQUIN	F 116

(5 Week Class - Starts 10/4/2010, Ends 11/5/2010)

7356	lec	7:00am - 7:50am	MTWThF	M.A. MARROQUIN	F 116
&	lab	7:50am - 12:00pm	MTWThF	M.A. MARROQUIN	F 116

(6 Week Class - Starts 11/8/2010, Ends 12/16/2010)

Evening Class

4390	lec	5:35pm - 6:30pm	TTh	R.P. GRISETT	F 116
&	lab	6:30pm - 9:30pm	TTh	R.P. GRISETT	F 116

**AUTOMOTIVE AND RELATED TECHNOLOGY 130
AUTOMOTIVE THEORY AND REPAIR I (CSU)** **3.00 UNITS**

Advanced course on engines and transmissions.

7358	lec	7:00am - 7:50am	MTWThF	R.C. SERRATO	F 132
&	lab	7:50am - 12:00pm	MTWThF	G.B. SPEAR	F 106

(5 Week Class - Starts 8/30/2010, Ends 10/1/2010)

**AUTOMOTIVE AND RELATED TECHNOLOGY 131
AUTOMOTIVE THEORY AND REPAIR II** **3.00 UNITS**

Advanced course on emission controls and fuel systems.

7360	lec	7:00am - 7:50am	MTWThF	R.C. SERRATO	F 132
&	lab	7:50am - 12:00pm	MTWThF	G.B. SPEAR	F 106

(5 Week Class - Starts 10/4/2010, Ends 11/5/2010)

**AUTOMOTIVE AND RELATED TECHNOLOGY 132
AUTOMOTIVE THEORY AND REPAIR III (CSU)** **3.00 UNITS**

Service and repair of electrical and electronic systems.

7362	lec	7:00am - 7:50am	MTWThF	R.C. SERRATO	F 132
&	lab	7:50am - 12:00pm	MTWThF	G.B. SPEAR	F 106

(6 Week Class - Starts 11/8/2010, Ends 12/16/2010)

**AUTOMOTIVE AND RELATED TECHNOLOGY 135
COMPUTER CONTROL AND FUEL INJECTION (CSU)** **3.00 UNITS**

7357	lec	7:00am - 7:50am	MTWThF	W.F. WOO	F 118
&	lab	7:50am - 12:00pm	MTWThF	W.F. WOO	F 118

(6 Week Class - Starts 11/8/2010, Ends 12/16/2010)

Evening Class

4385	lec	5:35pm - 6:30pm	T	G.B. SPEAR	F 118
&	lec	6:30pm - 9:30pm	Th	G.B. SPEAR	F 118

**AUTOMOTIVE AND RELATED TECHNOLOGY 136
AUTOMOTIVE EMISSION CONTROL SYSTEMS** **3.00 UNITS**

Includes preparation for State of California Bureau of Automotive Repair test.

Evening Class

4396	lec	5:35pm - 6:30pm	TTh	G.B. SPEAR	F 118
&	lab	6:30pm - 9:30pm	TTh	G.B. SPEAR	F 118

**AUTOMOTIVE AND RELATED TECHNOLOGY 140
AUTOMOTIVE THEORY AND REPAIR IV (CSU)** **3.00 UNITS**

7364	lec	7:00am - 7:50am	MTWThF	G.B. SPEAR	F 108
&	lab	7:50am - 12:00pm	MTWThF	G.B. SPEAR	F 104

(5 Week Class - Starts 8/30/2010, Ends 10/1/2010)

**AUTOMOTIVE AND RELATED TECHNOLOGY 141
AUTOMOTIVE THEORY AND REPAIR V (CSU)** **3.00 UNITS**

7365	lec	7:00am - 7:50am	MTWThF	G.B. SPEAR	F 124
&	lab	7:50am - 12:00pm	MTWThF	G.B. SPEAR	F 104

(5 Week Class - Starts 10/4/2010, Ends 11/5/2010)

**AUTOMOTIVE AND RELATED TECHNOLOGY 142
AUTOMOTIVE THEORY AND REPAIR VI (CSU)** **3.00 UNITS**

7366	lec	7:00am - 7:50am	MTWThF	G.B. SPEAR	F 130
&	lab	7:50am - 12:00pm	MTWThF	G.B. SPEAR	F 104

(6 Week Class - Starts 11/8/2010, Ends 12/16/2010)

**AUTOMOTIVE AND RELATED TECHNOLOGY 185
DIRECTED STUDY - AUTOMOTIVE AND RELATED TECHNOLOGY** **1.00 UNIT**

7367	lec	4:00 hrs/wk TBA	-	R.C. SERRATO	F 114
(5 Week Class - Starts 8/30/2010, Ends 10/1/2010)					
7368	lec	4:00 hrs/wk TBA	-	R.C. SERRATO	F 114
(5 Week Class - Starts 10/4/2010, Ends 11/5/2010)					
7369	lec	4:00 hrs/wk TBA	-	R.C. SERRATO	F 114
(6 Week Class - Starts 11/8/2010, Ends 12/16/2010)					

**AUTOMOTIVE AND RELATED TECHNOLOGY 285
DIRECTED STUDY - AUTOMOTIVE AND RELATED TECHNOLOGY** **2.00 UNITS**

7370	lec	8:05 hrs/wk TBA	-	R.C. SERRATO	F 114
(5 Week Class - Starts 8/30/2010, Ends 10/1/2010)					
7371	lec	8:15 hrs/wk TBA	-	R.C. SERRATO	F 114
(5 Week Class - Starts 10/4/2010, Ends 11/5/2010)					
7372	lec	8:15 hrs/wk TBA	-	R.C. SERRATO	F 114
(6 Week Class - Starts 11/8/2010, Ends 12/16/2010)					

**AUTOMOTIVE AND RELATED TECHNOLOGY 385
DIRECTED STUDY - AUTOMOTIVE AND RELATED TECHNOLOGY** **3.00 UNITS**

7373	lec	11:00 hrs/wk TBA	-	R.C. SERRATO	F 114
(5 Week Class - Starts 8/30/2010, Ends 10/1/2010)					
7374	lec	11:00 hrs/wk TBA	-	R.C. SERRATO	F 114
(5 Week Class - Starts 10/4/2010, Ends 11/5/2010)					
7375	lec	11:00 hrs/wk TBA	-	R.C. SERRATO	F 114
(6 Week Class - Starts 11/8/2010, Ends 12/16/2010)					

**AUTOMOTIVE AND RELATED TECHNOLOGY 941
COOPERATIVE EDUCATION - AUTOMOTIVE AND RELATED TECHNOLOGY** **4.00 UNITS**

See page 85 for detail and meeting times

9024	lec	4:25 hrs/wk TBA	-	C.A. MORLEY MOWER	D 236
------	-----	-----------------	---	-------------------	-------

**Don't Wait,
Get Online!!!**

- Registration
- FAQ's
- Counseling
- Financial Aid
- Grades
- Orientation

www.laftc.edu

Become a Certified Automotive Technician!

Did you know Trade-Tech offers a number of degrees and certificates in the fast-growing field of automotive technology? Hands-on courses are taught by automotive professionals in areas such as:

- » Transmission Repair
- » Motorcycle Repair Mechanics
- » Brake Suspension and Steering
- » Transmission Repair
- » Engine Performance Technology



AUTOMOTIVE COLLISION REPAIR

AUTOMOTIVE COLLISION REPAIR 114 3.00 UNITS BASIC WELDING THEORY AND PRACTICES

7300	lec	7:00am - 7:45am	TWThF	B.E. FERRE	F 120
&	lab	8:00am - 1:10pm	TWThF	B.E. FERRE	F 110

(5 Week Class - Starts 8/31/2010, Ends 10/1/2010)

AUTOMOTIVE COLLISION REPAIR 115 3.00 UNITS AUTO BODY CONSTRUCTION

7301	lec	7:00am - 7:45am	TWThF	B.E. FERRE	F 120
&	lab	8:00am - 1:10pm	TWThF	B.E. FERRE	F 110

(5 Week Class - Starts 10/5/2010, Ends 11/5/2010)

AUTOMOTIVE COLLISION REPAIR 116 3.00 UNITS BASIC COLLISION REPAIR

7302	lec	7:00am - 7:45am	TWThF	B.E. FERRE	F 120
&	lab	8:00am - 1:10pm	TWThF	B.E. FERRE	F 110

(6 Week Class - Starts 11/9/2010, Ends 12/16/2010)

AUTOMOTIVE COLLISION REPAIR 124 3.00 UNITS INTERMEDIATE COLLISION REPAIR-PARTS & REPLACEMENT ALIGNMENT

7303	lec	7:00am - 7:45am	TWThF	B.E. FERRE	F 120
&	lab	8:00am - 1:10pm	TWThF	B.E. FERRE	F 110

(5 Week Class - Starts 8/31/2010, Ends 10/1/2010)

AUTOMOTIVE COLLISION REPAIR 125 3.00 UNITS INTERMEDIATE COLLISION REPAIR-METAL REPAIR AND REFINISHING

7304	lec	7:00am - 7:45am	TWThF	B.E. FERRE	F 120
&	lab	8:00am - 1:10pm	TWThF	B.E. FERRE	F 110

(5 Week Class - Starts 10/5/2010, Ends 11/5/2010)

AUTOMOTIVE COLLISION REPAIR 126 3.00 UNITS INTERMEDIATE COLLISION REPAIR-FRAME STRAIGHTENING

7305	lec	7:00am - 7:45am	TWThF	B.E. FERRE	F 120
&	lab	8:00am - 1:10pm	TWThF	B.E. FERRE	F 110

(6 Week Class - Starts 11/9/2010, Ends 12/16/2010)

AUTOMOTIVE COLLISION REPAIR 134 3.00 UNITS BODY PANEL REPLACEMENT

7306	lec	1:15pm - 2:15pm	TWThF	F.J. MORAGO	F 120
&	lab	2:15pm - 6:45pm	TWThF	F.J. MORAGO	F 110

(5 Week Class - Starts 8/31/2010, Ends 10/1/2010)

AUTOMOTIVE COLLISION REPAIR 136 3.00 UNITS UNITIZED BODY AND FRAME ALIGNMENT

7307	lec	1:15pm - 2:15pm	TWThF	F.J. MORAGO	F 120
Team	lab	2:15pm - 6:45pm	TWThF	F.J. MORAGO	F 110

(5 Week Class - Starts 10/5/2010, Ends 11/5/2010)

7308	lec	1:15pm - 2:15pm	TWThF	F.J. MORAGO	F 120
&	lab	2:15pm - 6:45pm	TWThF	F.J. MORAGO	F 110

(6 Week Class - Starts 11/9/2010, Ends 12/16/2010)

Evening Class

4375	lec	6:45pm - 7:45pm	MW	S. MURADIAN	F 120
&	lab	7:45pm - 10:30pm	MW	S. MURADIAN	F 110

(5 Week Class - Starts 10/5/2010, Ends 11/5/2010)

AUTOMOTIVE COLLISION REPAIR 140 3.00 UNITS ADVANCED COLLISION REPAIR-ESTIMATING

7309	lec	1:15pm - 2:15pm	TWThF	F.J. MORAGO	F 120
&	lab	2:15pm - 6:45pm	TWThF	F.J. MORAGO	F 110

(5 Week Class - Starts 8/31/2010, Ends 10/1/2010)

Evening Class

4374	lec	6:45pm - 7:45pm	TTh	F.J. MORAGO	F 120
&	lab	7:45pm - 10:30pm	TTh	F.J. MORAGO	F 110

AUTOMOTIVE COLLISION REPAIR 144 3.00 UNITS ADVANCED COLLISION REPAIR-PRIMERS AND PAINTS

7310	lec	1:15pm - 2:15pm	TWThF	F.J. MORAGO	F 120
&	lab	2:15pm - 6:45pm	TWThF	F.J. MORAGO	F 110

(5 Week Class - Starts 10/5/2010, Ends 11/5/2010)

AUTOMOTIVE COLLISION REPAIR 145 3.00 UNITS ADVANCED COLLISION REPAIR-SPECIAL PROBLEMS & SOLUTIONS

7311	lec	1:15pm - 2:15pm	TWThF	F.J. MORAGO	F 120
&	lab	2:15pm - 6:45pm	TWThF	F.J. MORAGO	F 110

(6 Week Class - Starts 11/9/2010, Ends 12/16/2010)

7316	lec	8:30am - 9:30am	S	B.E. FERRE	F 120
&	lab	9:30am - 4:00pm	S	B.E. FERRE	F 110

**AUTOMOTIVE COLLISION REPAIR 148
PAINT PREPARATION AND APPLICATION** **3.00 UNITS**

7315	lec	8:30am - 9:30am	S	B.E. FERRE	F 120
&	lab	9:30am - 4:00pm	S	B.E. FERRE	F 110

**AUTOMOTIVE COLLISION REPAIR 149
ESTIMATING BODY DAMAGE** **3.00 UNITS**
Evening Class

4371	lec	6:45pm - 7:45pm	TTh	F.J. MORAGO	F 120
&	lab	7:45pm - 10:30pm	TTh	F.J. MORAGO	F 110

**AUTOMOTIVE COLLISION REPAIR 227
AUTO BODY AND FENDER II** **3.00 UNITS**
Evening Class

4370	lec	6:45pm - 7:45pm	MW	S. MURADIAN	F 120
&	lab	7:45pm - 10:30pm	MW	S. MURADIAN	F 110

**AUTOMOTIVE COLLISION REPAIR 941
COOPERATIVE EDUCATION - AUTOMOTIVE COLLISION REPAIR** **4.00 UNITS**

See page 85 for detail and meeting times

9025	lec	4:25 hrs/wk TBA	-	C.L. ANDERSON	D 236
------	-----	-----------------	---	---------------	-------

BAKING, PROFESSIONAL

**BAKING, PROFESSIONAL 101
ASSEMBLING AND DECORATING CAKES** **2.00 UNITS**

7548	lec	7:00am - 9:05am	F	D.M. THOMPSON	H 334
&	lab	9:05am - 1:20pm	F	D.M. THOMPSON	H 315
<i>(8 Week Class - Starts 10/29/2010, Ends 12/17/2010)</i>					

**CULINARY ARTS 111
CULINARY ARTS ORIENTATION I (CSU)** **4.00 UNITS**

Pre/corequisite: Cul Art 112

7500	lec	7:00am - 9:00am	TWTh	R.T. SPENCE	H 236
&	lab	9:00am - 12:40pm	TWTh	R.T. SPENCE	H 102
<i>(8 Week Class - Starts 8/30/2010, Ends 10/22/2010)</i>					
7503	lec	7:00am - 9:00am	TWTh	STAFF	H 236
&	lab	9:00am - 12:50pm	TWTh	STAFF	H 102
<i>(8 Week Class - Starts 10/25/2010, Ends 12/16/2010)</i>					
7504	lec	2:00pm - 4:05pm	TTh	D. WARRINER	H 132
&	lab	4:05pm - 6:20pm	TTh	D. WARRINER	H 107
<i>(16 Week Class - Starts 8/30/2010, Ends 12/16/2010)</i>					
7523	lec	1:30pm - 2:50pm	TWTh	J.M. LISANTI	H 119
&	lab	2:55pm - 7:55pm	TWTh	J.M. LISANTI	H 102
<i>(8 Week Class - Starts 10/25/2010, Ends 12/16/2010)</i>					

**BAKING, PROFESSIONAL 112
BAKING PROCESSES AND THEORY OF INGREDIENTS** **6.00 UNITS**

7541	lec	8:00am - 10:55am	TWTh	R.T. SPENCE	H 315
&	lab	10:55am - 4:10pm	TWTh	R.T. SPENCE	H 330
<i>(8 Week Class - Starts 10/25/2010, Ends 12/16/2010)</i>					
7549	lec	8:00am - 10:00am	MTWTh	S.D. DAMASO	H 315
&	lab	10:00am - 1:35pm	MTWTh	S.D. DAMASO	H 330
<i>(8 Week Class - Starts 8/30/2010, Ends 10/22/2010)</i>					

**CULINARY ARTS 112
SANITATION AND SAFETY (CSU)** **2.00 UNITS**

7501	lec	7:10am - 9:25am	MW	D. SCHERER	H 103
<i>(8 Week Class - Starts 10/25/2010, Ends 12/16/2010)</i>					
7502	lec	7:20am - 9:30am	MW	G. DELROSARIO	H 103
<i>(8 Week Class - Starts 8/30/2010, Ends 10/22/2010)</i>					
7505	lec	2:00pm - 4:05pm	MW	S.B. FEIGENBAUM	H 132
<i>(8 Week Class - Starts 8/30/2010, Ends 10/22/2010)</i>					
7526	lec	2:15pm - 4:25pm	TTh	G. DELROSARIO	H 301
<i>(8 Week Class - Starts 10/26/2010, Ends 12/19/2010)</i>					
7531	lec	2:10pm - 4:15pm	MW	S.B. FEIGENBAUM	H 132
<i>(8 Week Class - Starts 10/25/2010, Ends 12/16/2010)</i>					
Evening Classes					
7551	lec	4:20pm - 6:30pm	MW	S.B. FEIGENBAUM	H 132
<i>(8 Week Class - Starts 8/30/2010, Ends 10/20/2010)</i>					
7553	lec	4:25pm - 6:25pm	MW	S.B. FEIGENBAUM	H 132
<i>(8 Week Class - Starts 10/25/2010, Ends 12/19/2010)</i>					

**BAKING, PROFESSIONAL 121
BEGINNING YEAST BREADS AND QUICKBREADS** **6.00 UNITS**

7542	lab	6:45am - 10:25am	MTWTh	D.M. THOMPSON	H 315
&	lec	10:25am - 12:25pm	MTWTh	D.M. THOMPSON	H 334
<i>(8 Week Class - Starts 8/30/2010, Ends 10/22/2010)</i>					

**BAKING, PROFESSIONAL 122
ARTESIAN BREADS, SPECIALTY BREADS** **6.00 UNITS**

7543	lab	6:45am - 10:25am	MTWTh	S.D. DAMASO	H 330
&	lec	10:25am - 12:35pm	MTWTh	S.D. DAMASO	H 334
<i>(8 Week Class - Starts 10/25/2010, Ends 12/16/2010)</i>					

**BAKING, PROFESSIONAL 131
BAKING PROCEDURES AND THEORY OF INGREDIENTS II** **6.00 UNITS**

7544	lec	7:15am - 9:15am	MTWTh	R.B. WEMISCHNER	H 334
&	lab	9:15am - 12:55pm	MTWTh	R.B. WEMISCHNER	H 315
<i>(8 Week Class - Starts 8/30/2010, Ends 10/22/2010)</i>					

**BAKING, PROFESSIONAL 132
BAKING PROCESSES AND INGREDIENT CONTROL II** **6.00 UNITS**

7545	lec	7:15am - 9:15am	MTWTh	R.B. WEMISCHNER	H 334
&	lab	9:15am - 12:55pm	MTWTh	R.B. WEMISCHNER	H 315
<i>(8 Week Class - Starts 10/25/2010, Ends 12/16/2010)</i>					

**BAKING, PROFESSIONAL 141
BAKING PROCEDURES AND THEORY OF INGREDIENTS III** **6.00 UNITS**

7546	lab	6:45am - 10:35am	MTWTh	D.M. THOMPSON	H 315
&	lec	10:35am - 12:35pm	MTWTh	D.M. THOMPSON	H 334
<i>(8 Week Class - Starts 10/25/2010, Ends 12/18/2010)</i>					

**CULINARY ARTS 142
ADVANCED RESTAURANT PRACTICES II (CSU)** **6.00 UNITS**

7515	lab	6:45am - 10:25am	MTWTh	W.R. SHARP	H 107
&	lec	10:25am - 12:45pm	MTWTh	W.R. SHARP	H 109
<i>(8 Week Class - Starts 10/25/2010, Ends 12/16/2010)</i>					
7532	lab	6:45am - 10:20am	MTWTh	J.M. LISANTI	H 107
&	lec	10:25am - 12:30pm	MTWTh	J.M. LISANTI	H 109
<i>(8 Week Class - Starts 8/30/2010, Ends 10/22/2010)</i>					

**BAKING, PROFESSIONAL 941
COOPERATIVE EDUCATION - BAKING, PROFESSIONAL** **4.00 UNITS**

See page 85 for detail and meeting times

9028	lec	4:25 hrs/wk TBA	-	C.A. MORLEY MOWER	D 236
------	-----	-----------------	---	-------------------	-------

BIOLOGY

BIOLOGY 003 4.00 UNITS

INTRODUCTION TO BIOLOGY (UC:CSU)

Introduction to the fundamental properties of living things.

1610	lec	7:00am - 9:05am	MW	X.V. WRIGHT	K 468
&	lab	7:00am - 9:05am	F	X.V. WRIGHT	K 468
1611	lec	12:00pm - 3:10pm	T	M.C. PANTASTICO CALDAS	K 408
&	lab	12:00pm - 3:10pm	Th	M.C. PANTASTICO CALDAS	K 408
1613	lec	8:00am - 11:10am	S	R.L. STEWART	K 468
&	lab	12:00pm - 3:10pm	S	R.L. STEWART	K 468
Evening Classes					
4050	lec	6:00pm - 9:10pm	M	B.D. OLSEN	K 468
&	lab	6:00pm - 9:10pm	W	B.D. OLSEN	K 468
4051	lec	6:00pm - 9:10pm	T	K. NEDDERMEYER	K 408
&	lab	6:00pm - 9:10pm	Th	K. NEDDERMEYER	K 408
4052	lec	6:00pm - 9:10pm	M	S.W. LAVINGER	K 420
&	lab	6:00pm - 9:10pm	W	S.W. LAVINGER	K 420

BIOLOGY 006 5.00 UNITS

GENERAL BIOLOGY I (UC:CSU)

Prerequisite: Chemistry 51 or higher and Math 125.

Cellular and molecular processes for life science and pre-med majors.

1621	lec	9:05am - 12:10pm	M	M.C. PANTASTICO CALDAS	K 468
&	lab	9:05am - 12:10pm	WF	M.C. PANTASTICO CALDAS	K 468

BIOLOGY 020 8.00 UNITS

HUMAN ANATOMY AND PHYSIOLOGY (UC:CSU)

Prerequisite: Biology 3 or 36 with a grade of "C" or better

1630	lec	8:35am - 11:45am	MW	R.K. WONG	TE 107
&	lab	8:00am - 11:10am	T	R.K. WONG	K 468
&	lab	8:00am - 11:10am	Th	R.K. WONG	K 468
1631	lec	8:35am - 11:45am	MW	R.K. WONG	TE 107
&	lab	11:20am - 2:30pm	T	R.K. WONG	K 468
&	lab	11:20am - 2:30pm	Th	R.K. WONG	K 468
1632	lec	2:40pm - 5:50pm	MW	T.L. DENTON	TE 107
&	lab	2:40pm - 5:50pm	T	T.L. DENTON	K 468
&	lab	2:40pm - 5:50pm	Th	T.L. DENTON	K 468
1633	lec	2:40pm - 5:50pm	MW	T.L. DENTON	TE 107
&	lab	6:00pm - 9:10pm	T	T.L. DENTON	K 468
&	lab	6:00pm - 9:10pm	Th	T.L. DENTON	K 468

BIOLOGY 036 4.00 UNITS

BIOSCIENCE FOR HEALTH OCCUPATIONS

1640	lec	12:30pm - 3:40pm	M	E.H. BROCKMANN	K 468
&	lab	12:30pm - 3:40pm	W	E.H. BROCKMANN	K 468
1641	lec	8:00am - 11:10am	F	O.B. GBONEGUN	K 406
&	lab	12:30pm - 3:40pm	F	O.B. GBONEGUN	K 468



**Don't Wait,
Get Online!!!**

- Registration
- FAQ's
- Counseling
- Financial Aid
- Grades
- Orientation

www.lattc.edu

BUILDING CONSTRUCTION TECHNIQUES

BUILDING CONSTRUCTION TECHNIQUES 002 3.00 UNITS

PRE-EMPLOYMENT APPLIED TRADES CALCULATIONS AND MEASUREMENT

8331	lec	12:10pm - 1:35pm	TTh	W.G. HANLEY	B 301
------	-----	------------------	-----	-------------	-------

BUILDING CONSTRUCTION TECHNIQUES 003 2.00 UNITS

MATERIALS OF THE BUILDING INDUSTRY

8332	lab	1:40pm - 4:50pm	TTh	J.B. LESTER	B 301
------	-----	-----------------	-----	-------------	-------

BUILDING CONSTRUCTION TECHNIQUES 004 3.00 UNITS

PRINCIPLES OF HAND AND POWER TOOLS

8333	lab	1:35pm - 4:45pm	MWF	T.G. NIEVES	B 301
------	-----	-----------------	-----	-------------	-------

BUILDING CONSTRUCTION TECHNIQUES 007 3.00 UNITS

WEATHERIZATION - PRACTICAL ENERGY EFFICIENCY TECHNIQUES

6972	lec	12:30pm - 5:00pm	MTWThF	T.J. VESSELLA	B 104
<i>(3 Week Class - Starts 10/6/2010, Ends 10/21/2010)</i>					
9509	lec	12:00pm - 4:50pm	MTWThF	T.J. VESSELLA	B 105
&	lec	1:00 hrs/wk TBA	-	T.J. VESSELLA	TBA
<i>(2 Week Class - Starts 11/8/2010, Ends 11/19/2010)</i>					

BUILDING CONSTRUCTION TECHNIQUES 101 3.00 UNITS

CONTRACT'S LICENSE LAW (CSU)

Evening Class					
4840	lec	6:00pm - 9:35pm	F	G.A. THOMPSON	B 351

BUSINESS

BUSINESS 001 3.00 UNITS

INTRODUCTION TO BUSINESS (UC:CSU)

0130	lec	8:35am - 10:00am	TTh	J. AHMAD	K 321
0131	lec	10:10am - 11:35am	MW	M.C. BESSLER	K 262

Evening Class					
3016	lec	6:00pm - 9:10pm	M	R.S. SHERER	K 262

BUSINESS 005 3.00 UNITS

BUSINESS LAW I (UC:CSU)

0141	lec	1:20pm - 2:45pm	MW	K.L. GARY	K 324
------	-----	-----------------	----	-----------	-------

Evening Classes					
3017	lec	5:30pm - 8:40pm	Th	S.B. SCUDDER	K 222
&	lec	8:00am - 12:05pm	S	S.B. SCUDDER	K 222
<i>(8 Week Class - Starts 10/21/2010, Ends 12/16/2010)</i>					
3018	lec	6:00pm - 9:10pm	Th	J.D. ENDMAN	K 262

BUSINESS 012 3.00 UNITS

CUSTOMER SERVICE PRINCIPLES

0142	lec	10:10am - 11:35am	TTh	M.C. BESSLER	K 262
------	-----	-------------------	-----	--------------	-------

BUSINESS 022 **3.00 UNITS**
THE BUSINESS OF ELECTRIC COMMERCE

0148 lec 11:45am - 1:10pm MW M.C. BESSLER K 262

BUSINESS 032 **3.00 UNITS**
BUSINESS COMMUNICATIONS (CSU)

0145 lec 9:45am - 10:50am TTh D.M. THORNHILL K 320

& lab 10:50am - 11:50am TTh D.M. THORNHILL K 320

3019 lec 5:00pm - 7:05pm W Y.O. TOURE K 320

& lab 7:05pm - 9:15pm W Y.O. TOURE K 320

BUSINESS 038 **3.00 UNITS**
BUSINESS COMPUTATIONS (CSU)

0146 lec 8:35am - 10:00am MW J. AHMAD K 321

0147 lec 10:10am - 11:35am TTh R.S. SHERER K 258

Evening Class

3024 lec 6:00pm - 9:10pm W R.S. SHERER K 262

BUSINESS 941 **4.00 UNITS**
COOPERATIVE EDUCATION - BUSINESS (CSU)

See page 85 for detail and meeting times

9032 lec 4:25 hrs/wk TBA - C.L. ANDERSON D 236

CABINET MAKING AND MILLWORK

CABINET MAKING AND MILLWORK 170 **3.00 UNITS**
INTRODUCTION TO CNC WOODWORKING MACHINING CENTER

Furniture and other CNC applications.

8034 lec 12:30pm - 1:15pm TTh L. HUBBARD B 120

& lab 1:15pm - 3:35pm TTh L. HUBBARD B 120

CARPENTRY

CARPENTRY 105 **3.00 UNITS**
CALCULATIONS AND MEASUREMENT FOR WOODWORKING STUDENTS I

8103 lec 10:40am - 12:10pm TTh L. HUBBARD B 136

Evening Class

4705 lec 6:00pm - 9:10pm T W.G. HANLEY B 136

CARPENTRY 111A **3.00 UNITS**
CONSTRUCTION I

Use and operation of standard industry tools.

Evening Class

4703 lec 6:00pm - 9:10pm M R.W. DUNN B 105

CARPENTRY 114 **4.00 UNITS**
HAND AND POWER TOOL APPLICATION

8104 lec 7:00am - 7:20am MWF L. HUBBARD B 136

& lab 7:20am - 10:30am MWF L. HUBBARD B 104

CARPENTRY 115 **3.00 UNITS**
BASIC BLUEPRINT READING

8105 lec 7:00am - 7:20am TTh L. HUBBARD B 136

& lab 7:20am - 10:30am TTh L. HUBBARD B 104

CARPENTRY 117 **2.00 UNITS**
CONSTRUCTION MATERIALS

8106 lec 10:40am - 11:10am MWF L. HUBBARD B 136

& lab 11:10am - 12:10pm MWF L. HUBBARD B 104

CARPENTRY 123 **4.00 UNITS**
BASIC HOUSE CONSTRUCTION

8114 lec 7:00am - 7:50am MW W.G. HANLEY B 133

& lab 7:00am - 10:10am TTh W.G. HANLEY B 104

CARPENTRY 124 **3.00 UNITS**
BLUEPRINT READING II

8115 lec 7:00am - 8:00am F W.G. HANLEY B 133

& lab 8:00am - 10:10am MWF W.G. HANLEY B 104

CARPENTRY 129 **2.00 UNITS**
BASIC RESIDENTIAL ESTIMATING

8116 lab 10:10am - 12:15pm MWF W.G. HANLEY B 104

CARPENTRY 130 **3.00 UNITS**
CALCULATIONS AND MEASUREMENT FOR WOODWORKING STUDENTS II

8110 lec 10:30am - 11:55am TTh T.J. VESSELLA B 133

Evening Class

4701 lec 6:00pm - 9:10pm W STAFF B 136

CARPENTRY 132 **3.00 UNITS**
APPLIED BLUEPRINT READING

8120 lec 6:45am - 7:35am F R.W. DUNN B 105

& lab 8:25am - 10:45am MWF R.W. DUNN B 104

CARPENTRY 133 **3.00 UNITS**
ADVANCED RESIDENTIAL ESTIMATING

8121 lec 7:00am - 8:25am MW R.W. DUNN B 105

CARPENTRY 134 **4.00 UNITS**
ADVANCED RESIDENTIAL CONSTRUCTION

8131 lec 7:00am - 8:05am TTh R.W. DUNN B 105

& lab 8:25am - 10:50am TTh R.W. DUNN B 105

CARPENTRY 135 **2.00 UNITS**
CONCRETE CONSTRUCTION

8132 lec 7:35am - 8:25am F R.W. DUNN B 105

& lab 10:50am - 11:30am MTWThF R.W. DUNN B 105

CARPENTRY 144 **4.00 UNITS**
RESIDENTIAL EXTERIOR FINISH

8118 lec 7:00am - 8:05am M R.W. DUNN B 102

& lab 8:15am - 11:25am MWF R.W. DUNN B 104

CARPENTRY 145 **5.00 UNITS**
RESIDENTIAL INTERIOR FINISH

8119 lec 7:00am - 8:05am WF R.W. DUNN B 102

& lab 7:00am - 11:55am TTh R.W. DUNN B 104

**CARPENTRY 149
COMPUTER ASSISTED ESTIMATING II** **3.00 UNITS****Evening Class**

4747	lec	6:00pm - 6:50pm	MW	G.K. WOO	C 201
&	lab	6:50pm - 9:10pm	MW	G.K. WOO	C 201

**CARPENTRY 241
BLUEPRINT READING AND ESTIMATING** **3.00 UNITS****Evening Class**

4702	lec	6:00pm - 9:10pm	W	R.J. LAWRENCE	B 105
------	-----	-----------------	---	---------------	-------

**CARPENTRY 243
BUILDING ESTIMATING I** **3.00 UNITS****Evening Class**

4839	lec	6:00pm - 9:10pm	T	R.W. DUNN	B 105
------	-----	-----------------	---	-----------	-------

**CARPENTRY 251
UNIFORM BUILDING CODE I** **3.00 UNITS****Evening Class**

4704	lec	6:00pm - 9:10pm	Th	W.G. HANLEY	B 105
------	-----	-----------------	----	-------------	-------

CHEMICAL TECHNOLOGY

**CHEMICAL TECHNOLOGY 111
APPLIED CHEMISTRY I (CSU)** **5.00 UNITS**

1650	lec	10:10am - 11:35am	M	R.M. MADYUN	K 464
&	lab	8:00am - 11:10am	F	D.A. JEFFRESS	K 464
&	lab	7:00am - 11:35am	T	R.M. MADYUN	K 464
1652	lab	9:00am - 12:10pm	F	G. ACERO	K 464
&	lab	3:35 hrs/wk TBA	-	G. ACERO	K 464
&	lec	10:10am - 11:35am	MT	R.M. MADYUN	K 464

Evening Class

4081	lec	6:00pm - 9:10pm	M	R.M. BABAJIDE	K 424
&	lab	9:10pm - 10:15pm	M	R.M. BABAJIDE	K 424
&	lab	6:00pm - 10:10pm	T	R.M. BABAJIDE	K 424
&	lab	1:00 hrs/wk TBA	-	R.M. BABAJIDE	K 422

**CHEMICAL TECHNOLOGY 113
APPLIED CHEMISTRY MATHEMATICS I** **2.00 UNITS**

1651	lec	7:00am - 8:10am	W	V. HARUTUNIAN	K 464
&	lec	10:20am - 11:20am	W	V. HARUTUNIAN	K 464

**CHEMICAL TECHNOLOGY 132
QUANTITATIVE AND INSTRUMENTAL ANALYSIS I (CSU)** **5.00 UNITS**

1656	lec	7:00am - 10:10am	W	R.M. MADYUN	K 466
&	lab	10:20am - 11:55am	W	R.M. MADYUN	K 466
&	lab	7:00am - 11:45am	Th	R.M. MADYUN	K 466

**CHEMICAL TECHNOLOGY 133
ORGANIC CHEMISTRY I (CSU)** **4.00 UNITS**

1657	lec	7:00am - 8:50am	M	V. HARUTUNIAN	K 466
&	lab	8:50am - 12:00pm	M	V. HARUTUNIAN	K 466
&	lab	7:00am - 9:10am	T	V. HARUTUNIAN	K 466

**CHEMICAL TECHNOLOGY 161
SPECIAL PROJECTS I** **1.00 UNIT**

1660	lab	3:25 hrs/wk TBA	-	V. HARUTUNIAN	K 466
------	-----	-----------------	---	---------------	-------

**CHEMICAL TECHNOLOGY 162
SPECIAL PROJECTS II** **2.00 UNITS**

1661	lab	6:30 hrs/wk TBA	-	STAFF	K 466
1663	lab	6:30 hrs/wk TBA	-	R.M. MADYUN	K 469

**CHEMICAL TECHNOLOGY 168
CHEMICAL QUALITY CONTROL I** **2.00 UNITS**

1662	lab	10:20am - 11:50am	T	V. HARUTUNIAN	K 466
&	lab	7:00am - 11:50am	F	V. HARUTUNIAN	K 466

CHEMISTRY

**CHEMISTRY 051
FUNDAMENTALS OF CHEMISTRY I (UC:CSU)** **5.00 UNITS**

Prerequisite: Math 115 or Math 113 and 114 or higher.

1670	lec	10:10am - 11:45am	MW	M. DIAZ	K 406
&	lec	9:10am - 10:00am	M	V. SACHDEV	K 406
&	lab	12:00pm - 3:00pm	M	M. DIAZ	K 464
1671	lec	10:10am - 11:45am	MW	M. DIAZ	K 406
&	lec	9:10am - 10:00am	M	V. SACHDEV	K 406
&	lab	12:00pm - 3:00pm	W	M. DIAZ	K 464
1672	lec	8:10am - 12:10pm	T	B.E. RUIZ SILVA	K 406
&	lec	9:00am - 12:00pm	Th	STAFF	K 464
1674	lab	8:00am - 11:10am	S	S.H. PARKIN	K 464
&	lec	12:00pm - 4:10pm	S	S.H. PARKIN	K 301

Evening Class

4070	lec	4:45pm - 6:50pm	TTh	H.O. AJIE	K 301
&	lab	6:50pm - 10:00pm	T	H.O. AJIE	K 464

**CHEMISTRY 070
INTRODUCTORY ORGANIC AND BIOCHEMISTRY (UC:CSU)** **4.00 UNITS**

Prerequisite: Chemistry 51 or 65 or 101 with a grade of "C" or better.

1634	lec	8:00am - 11:10am	S	P.M. DARMANYAN	K 406
&	lab	12:00pm - 3:10pm	S	P.M. DARMANYAN	K 464

**CHEMISTRY 101
GENERAL CHEMISTRY I (UC:CSU)** **5.00 UNITS**

Prerequisite: Math 125 or higher with a grade of "C" or better.

1680	lec	10:10am - 11:50am	MW	STAFF	K 368
&	lab	12:00pm - 3:00pm	MW	V. SACHDEV	K 466
1695	lec	10:10am - 11:45am	TTh	H.O. AJIE	K 368
&	lab	11:50am - 3:00pm	TTh	K.F. HOUBEN	K 466

Evening Class

4075	lec	4:35pm - 6:00pm	TTh	H. LEE	K 364
&	lab	6:10pm - 9:20pm	TTh	H. LEE	K 466

**CHEMISTRY 102
GENERAL CHEMISTRY II (UC:CSU)** **5.00 UNITS**

Prerequisite: Chemistry 101 and Math 125 or higher with a grade of "C" or better.

1682	lec	1:10pm - 2:50pm	TTh	M. DIAZ	K 321
&	lab	3:00pm - 6:00pm	TTh	M. DIAZ	K 466

Evening Class

4077	lec	4:35pm - 6:00pm	MW	M. ACOSTA	K 364
&	lab	6:10pm - 9:15pm	MW	M. ACOSTA	K 466

CHEMISTRY 185 **1.00 UNIT**
DIRECTED STUDY - CHEMISTRY (UC:CSU)
 1683 lec 1:00 hrs/wk TBA - M. DIAZ TBA

CHEMISTRY 211 **5.00 UNITS**
ORGANIC CHEMISTRY FOR SCIENCE MAJORS I (UC:CSU)
 Prerequisite: Chem 102 with a grade of "C" or better.

1684 lec 1:10pm - 2:30pm WF B.E. RUIZ SILVA K 406
 & lab 3:00pm - 9:00pm W M. DIAZ K 464
 1687 lec 1:10pm - 2:30pm WF B.E. RUIZ SILVA K 406
 & lab 3:00pm - 9:00pm F B.E. RUIZ SILVA K 464

CHEMISTRY 212 **5.00 UNITS**
ORGANIC CHEMISTRY FOR SCIENCE MAJORS II (UC:CSU)
 Prerequisite: Chemistry 211 with a grade of "C" or better.

1685 lec 1:10pm - 3:00pm MW K.F. HOUBEN K 368
 & lab 3:00pm - 9:00pm M M.Z. VISI K 464
 1688 lec 1:10pm - 3:00pm MW K.F. HOUBEN K 368
 & lab 3:00pm - 6:00pm MW K.F. HOUBEN K 466

CHEMISTRY 221 **5.00 UNITS**
BIOCHEMISTRY FOR SCIENCE MAJORS (UC:CSU)
 Prerequisite: Chemistry 211 with a grade of "C" or better.

1698 lec 10:40am - 11:35am TTh B.E. RUIZ SILVA K 406
 & lab 12:00pm - 6:00pm T B.E. RUIZ SILVA K 464
 1699 lec 10:10am - 11:35am TTh B.E. RUIZ SILVA K 406
 & lab 12:00pm - 6:00pm Th B.E. RUIZ SILVA K 464

CHEMISTRY 385 **3.00 UNITS**
DIRECTED STUDY - CHEMISTRY (UC:CSU)
 1686 lec 3:00 hrs/wk TBA - B.E. RUIZ SILVA K 464

CHILD DEVELOPMENT

CHILD DEVELOPMENT 001 **3.00 UNITS**
CHILD GROWTH AND DEVELOPMENT (UC:CSU)

Advisory: English 28.

Childhood development from conception through adolescence.

1200 lec 10:10am - 11:35am MW C. VEGA K 222
 1201 lec 8:35am - 10:00am TTh J.Y. BABB K 222
 1205 lec 10:10am - 11:35am TTh J.Y. BABB K 222
 1206 lec 11:45am - 1:10pm MW M.D. Benjamin K 222
 7931 lec 3:15 hrs/wk TBA - J.Y. BABB ON LINE

- Please visit the online program homepage at <http://moodle.lattc.edu> prior to the start of class for directions, or see pages 82-84 of this schedule for more information.

Evening Classes

3701 lec 6:00pm - 9:10pm Th R.W. ESSEX K 258
 3702 lec 6:00pm - 9:10pm M R.G. MAINA K 222

CHILD DEVELOPMENT 002 **3.00 UNITS**
EARLY CHILDHOOD: PRINCIPLES AND PRACTICES (CSU)

TB clearance required. Prerequisite: Child Development 1.

1208 lec 8:35am - 10:00am MW J.Y. BABB K 262
 1209 lec 9:00am - 12:10pm S M.J. UDEOCHU K 262

Evening Class

3700 lec 6:00pm - 9:10pm T R.G. MAINA K 222

Child Development Courses Flow Chart

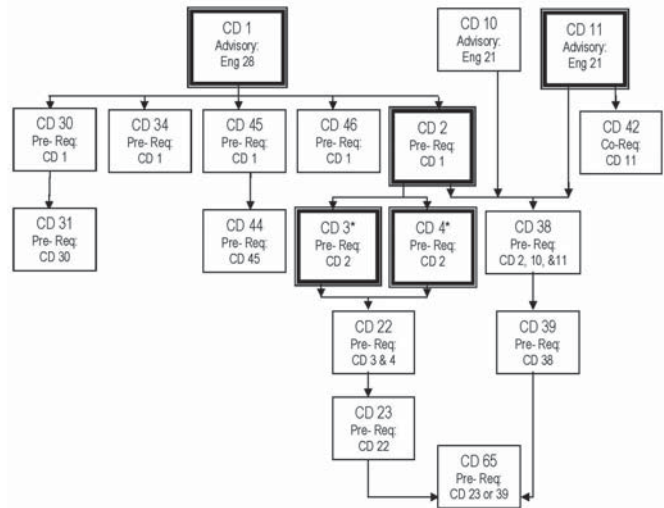

Core Courses

* It is not recommended to take both CD 3 & 4 at the same time.

CHILD DEVELOPMENT 004 **3.00 UNITS**
CREATIVE EXPERIENCES FOR CHILDREN II (CSU)

Prerequisite: Child Development 2.

Curriculum and lesson planning: math and science.

1210 lec 11:45am - 2:55pm T R.M. MCLAUGHLIN H 340
 1211 lec 11:45am - 2:55pm W C. VEGA H 340

Evening Class

3714 lec 6:00pm - 9:10pm Th A. CHELSTROM H 340

CHILD DEVELOPMENT 010 **3.00 UNITS**
HEALTH, SAFETY AND NUTRITION (CSU)

Advisory: English 21.

1215 lec 10:10am - 11:35am MW G.J. RODRIGUEZ K 258
 1216 lec 8:35am - 10:00am TTh C. VEGA H 314

Evening Class

3721 lec 6:00pm - 9:10pm W J. WILLIAMS K 222

CHILD DEVELOPMENT 011 **3.00 UNITS**
HOME, SCHOOL, AND COMMUNITY RELATIONS (CSU)

Advisory: English 21.

1218 lec 11:45am - 1:10pm TTh C. VEGA H 301
 1220 lec 8:35am - 10:00am MW D.E. DICKERSON K 258

Evening Class

3725 lec 6:00pm - 9:10pm M M.T. ROSTAMI K 258

CHILD DEVELOPMENT 022 **4.00 UNITS**
PRACTICUM IN CHILD DEVELOPMENT I (CSU)

Prerequisite: Child Development 3, 4.

Students are required to complete 90 hours an approved field site. Must be available between 8:00 a.m. and noon.

Evening Class

3727 lec 6:00pm - 8:05pm W M.A. LOVETT H 314
 & lab 6:45 hrs/wk TBA - M.A. LOVETT H 314

**CHILD DEVELOPMENT 023
PRACTICUM IN CHILD DEVELOPMENT II (CSU)**

4.00 UNITS

Prerequisite: Child Development 22.

Evening Class

3734	lec	6:00pm - 8:05pm	W	R.G. MAINA	H 340
&	lab	6:35 hrs/wk TBA	-	R.G. MAINA	H 340

**CHILD DEVELOPMENT 030
INFANT AND TODDLER STUDIES I (CSU)**

3.00 UNITS

Prerequisite: Child Development 1.

1222	lec	11:45am - 1:10pm	TTh	J.Y. BABB	K 222
------	-----	------------------	-----	-----------	-------

Evening Class

3703	lec	6:00pm - 9:10pm	W	R.B. ESTROFF	K 258
------	-----	-----------------	---	--------------	-------

**CHILD DEVELOPMENT 034
OBSERVING AND RECORDING CHILDREN'S BEHAVIOR (CSU)**

3.00 UNITS

Prerequisite: Child Development 1.

1224	lec	11:45am - 1:10pm	MW	L.B. GRAY	K 258
------	-----	------------------	----	-----------	-------

Evening Class

3740	lec	6:00pm - 9:10pm	T	W.S. KIEL	K 262
------	-----	-----------------	---	-----------	-------

**CHILD DEVELOPMENT 038
ADMINISTRATION & SUPERVISION OF EARLY CHILDHOOD PROGRAMS I (CSU)**

3.00 UNITS

Prerequisites: Child Development 2, 10, 11.

1226	lec	10:00am - 11:35am	MW	J.Y. BABB	H 337
------	-----	-------------------	----	-----------	-------

Evening Class

3742	lec	6:00pm - 9:10pm	Th	I.H. KAPLAN	H 301
------	-----	-----------------	----	-------------	-------

**CHILD DEVELOPMENT 042
THE CHILD IN A DIVERSE SOCIETY (CSU)**

3.00 UNITS

Corequisite: Child Development 11.

1228	lec	10:10am - 11:35am	TTh	C. VEGA	H 301
------	-----	-------------------	-----	---------	-------

Evening Class

3744	lec	6:00pm - 9:10pm	Th	R.G. MAINA	K 321
------	-----	-----------------	----	------------	-------

**CHILD DEVELOPMENT 044
PROGRAMS FOR CHILDREN WITH SPECIAL NEEDS I (CSU)**

3.00 UNITS

Prerequisite: Child Development 45.

1230	lec	8:35am - 10:00am	MW	C. VEGA	K 222
------	-----	------------------	----	---------	-------

**CHILD DEVELOPMENT 047
SCHOOL AGE PROGRAMS II (CSU)**

3.00 UNITS

1232	lec	9:00am - 12:10pm	S	M.R. DEZGARAN	K 258
------	-----	------------------	---	---------------	-------

**CHILD DEVELOPMENT 065
ADULT SUPERVISION/EARLY CHILDHOOD MENTORING (CSU)**

2.00 UNITS

Prerequisite: Child Development 23 or 39.

Evening Class

3735	lec	6:00pm - 9:30pm	T	E.A. GOMEZ	H 301
<i>(10 Week Class - Starts 8/30/2010, Ends 11/6/2010)</i>					

**CHILD DEVELOPMENT 941
COOPERATIVE EDUCATION - CHILD DEVELOPMENT (CSU)**

4.00 UNITS

See page 85 for detail and meeting times

9048	lec	4:25 hrs/wk TBA	-	C.A. MORLEY MOWER	D 236
------	-----	-----------------	---	-------------------	-------

COMMUNITY PLANNING/ ECONOMIC DEVELOPMENT

**COMMUNITY PLANNING/ECONOMIC DEVELOPMENT 001 3.00 UNITS
INTRODUCTION TO COMMUNITY ECONOMIC DEVELOPMENT (CSU)**
Evening Classes

4950	lec	5:30pm - 9:20pm	T	D.G. FAIRCHILD	TE 213
&	lec	9:00am - 2:50pm	S	D.G. FAIRCHILD	TE 213

(12 Week Class - Starts 9/28/2010, Ends 12/14/2010)
**COMMUNITY PLANNING/ECONOMIC DEVELOPMENT 002 3.00 UNITS
INTRODUCTION TO COMMUNITY ORGANIZING (CSU)**
Evening Class

4957	lec	5:30pm - 9:20pm	W	L. HERNANDEZ	TE 312
&	lec	9:00am - 2:50pm	S	L. HERNANDEZ	TE 312

(12 Week Class - Starts 9/1/2010, Ends 11/17/2010)
**COMMUNITY PLANNING/ECONOMIC DEVELOPMENT 003 3.00 UNITS
AFFORDABLE HOUSING DEVELOPMENT (CSU)**
Evening Class

4961	lec	5:30pm - 9:20pm	Th	J.L. ELLIOTT	TE 208
&	lec	9:00am - 4:50pm	S	J.L. ELLIOTT	TE 208

(10 Week Class - Starts 9/30/2010, Ends 12/16/2010)
**COMMUNITY PLANNING/ECONOMIC DEVELOPMENT 022 1.00 UNIT
STRATEGIC MEDIA AND COMMUNICATIONS FOR ORGANIZING (CSU)**
Evening Class

4995	lec	5:30pm - 9:50pm	M	STAFF	OFF CAMP
------	-----	-----------------	---	-------	----------

(4 Week Class - Starts 11/22/2010, Ends 12/13/2010)
**COMMUNITY PLANNING/ECONOMIC DEVELOPMENT 035 3.00 UNITS
HEALTH LEADERSHIP AND COMMUNITY DEVELOPMENT**
Evening Class

4962	lec	5:30pm - 9:40pm	M	M.M. LEE	TE 313
&	lec	9:00am - 2:50pm	S	M.M. LEE	TE 313

(12 Week Class - Starts 8/30/2010, Ends 11/22/2010)
**COMMUNITY PLANNING/ECONOMIC DEVELOPMENT 036 3.00 UNITS
INTRODUCTION TO APPLIED COMMUNITY DEVELOPMENT RESEARCH (UC:CSU)**
Evening Class

4958	lec	5:30pm - 9:45pm	W	STAFF	TE 301
&	lec	9:00am - 2:50pm	S	STAFF	TE 301

(12 Week Class - Starts 9/1/2010, Ends 11/17/2010)
**COMMUNITY PLANNING/ECONOMIC DEVELOPMENT 040 2.00 UNITS
NON-PROFIT PROGRAM DESIGN AND DEVELOPMENT (UC:CSU)**
Evening Classes

4963	lec	5:30pm - 9:50pm	M	B. TORRES	TE 312
------	-----	-----------------	---	-----------	--------

(8 Week Class - Starts 8/30/2010, Ends 10/25/2010)

4990	lec	5:30pm - 9:20pm	Th	STAFF	TE 412
------	-----	-----------------	----	-------	--------

(9 Week Class - Starts 9/16/2010, Ends 11/18/2010)

**COMMUNITY PLANNING/ECONOMIC DEVELOPMENT 041 1.00 UNIT
TIME MANAGEMENT SKILLS FOR COMMUNITY DEVELOPMENT SPECIALIST
(UC:CSU)**
Evening Class

4959 lec 5:30pm - 9:50pm W STAFF TE 306
(4 Week Class - Starts 11/24/2010, Ends 12/15/2010)

**COMMUNITY PLANNING/ECONOMIC DEVELOPMENT 050 3.00 UNITS
PRACTICAL MULTI-FAMILY/APARTMENT MANAGER (CSU)**
Evening Classes

4964 lec 5:30pm - 9:20pm T J. HARRIS TE 301
& lec 9:00am - 2:50pm S J. HARRIS TE 301
(12 Week Class - Starts 9/28/2010, Ends 12/14/2010)
4993 lec 6:00pm - 9:00pm W STAFF TE 412

**COMMUNITY PLANNING/ECONOMIC DEVELOPMENT 385 3.00 UNITS
DIRECTED STUDY - COMMUNITY PLANNING & ECONOMIC DEVELOPMENT
(CSU)**
Evening Class

4991 lec 3:25 hrs/wk TBA - STAFF C 202

COMPUTER APPLICATIONS OFFICE TECHNOLOGIES

**COMPUTER APPLICATIONS OFFICE TECHNOLOGIES 001 3.00 UNITS
COMPUTER KEYBOARDING I (CSU)**

Fundamentals of keyboarding and letter writing.

0201 lec 8:00am - 9:05am MW V.T. PALACIOS K 304
& lab 9:05am - 10:30am MW V.T. PALACIOS K 304
0202 lec 10:15am - 11:20am MW D.M. THORNHILL K 320
& lab 11:20am - 12:45pm MW D.M. THORNHILL K 320
0203 lec 10:15am - 11:20am TTh O.K. KAPAKU K 210
& lab 11:20am - 12:45pm TTh O.K. KAPAKU K 210

**COMPUTER APPLICATIONS OFFICE TECHNOLOGIES 002 3.00 UNITS
COMPUTER KEYBOARDING II (CSU)**

Increase computer keyboarding skills and improve business and legal document development in MS Word.

0207 lec 7:30am - 8:35am MW P. BAILEY K 208
& lab 8:35am - 10:00am MW P. BAILEY K 208

**COMPUTER APPLICATIONS OFFICE TECHNOLOGIES 007 3.00 UNITS
MACHINE TRANSCRIPTION (CSU)**

Voice transcription keyboarding.

0210 lec 8:00am - 9:05am MW D.M. THORNHILL K 320
& lab 9:05am - 10:05am MW D.M. THORNHILL K 320

**COMPUTER APPLICATIONS OFFICE TECHNOLOGIES 020 5.00 UNITS
MEDICAL OFFICE PROCEDURES (CSU)**

0220 lec 8:30am - 10:40am F S.B. HAYMON K 320
& lec 11:00am - 1:20pm F S.B. HAYMON K 320

**COMPUTER APPLICATIONS OFFICE TECHNOLOGIES 030 3.00 UNITS
OFFICE PROCEDURES (CSU)**

0230 lec 8:00am - 9:00am MW E.J. CHU K 210
& lab 9:00am - 10:05am MW E.J. CHU K 210

**COMPUTER APPLICATIONS OFFICE TECHNOLOGIES 031 3.00 UNITS
BUSINESS ENGLISH (CSU)**

0231 lec 8:00am - 9:25am TTh D.M. THORNHILL K 320

**COMPUTER APPLICATIONS OFFICE TECHNOLOGIES 033 2.00 UNITS
RECORDS MANAGEMENT AND FILING**

0233 lec 10:15am - 10:45am MW STAFF K 322
& lab 10:45am - 11:50am MW STAFF K 322

**COMPUTER APPLICATIONS OFFICE TECHNOLOGIES 044 3.00 UNITS
MEDICAL TERMINOLOGY (CSU)**

Comprehensive medical vocabulary and usage.

0236 lec 1:00pm - 2:25pm MW D.M. THORNHILL K 320

**COMPUTER APPLICATIONS OFFICE TECHNOLOGIES 082 3.00 UNITS
MICROCOMPUTER SOFTWARE SURVEY IN THE OFFICE (CSU)**

0246 lec 8:00am - 10:10am F P. BAILEY K 208
& lab 10:10am - 1:20pm F P. BAILEY K 208
0249 lec 11:00am - 12:05pm TTh W. BURTON K 208
& lab 12:05pm - 1:30pm TTh W. BURTON K 208
7959 lec 4:25 hrs/wk TBA - S.Y. BAKLAYAN ON LINE
& lab 1:00 hrs/wk TBA - S.Y. BAKLAYAN ON LINE

- Please visit the online program homepage at <http://moodle.lattc.edu> prior to the start of class for directions, or see pages 82-84 of this schedule for more information.

**COMPUTER APPLICATIONS OFFICE TECHNOLOGIES 084 3.00 UNITS
MICROCOMPUTER OFFICE APPLICATIONS: WORD PROCESSING (CSU)**

7962 lec 1:05 hrs/wk TBA - S.Y. BAKLAYAN ON LINE
& lab 4:25 hrs/wk TBA - S.Y. BAKLAYAN ON LINE

- Please visit the online program homepage at <http://moodle.lattc.edu> prior to the start of class for directions, or see pages 82-84 of this schedule for more information.

**COMPUTER APPLICATIONS OFFICE TECHNOLOGIES 085 3.00 UNITS
MICROCOMPUTER OFFICE APPLICATIONS: SPREADSHEET (CSU)**

0248 lec 8:00am - 10:10am S S.Y. BAKLAYAN K 208
& lab 10:10am - 1:20pm S S.Y. BAKLAYAN K 208
7863 lec 5:25 hrs/wk TBA - S.Y. BAKLAYAN ON LINE

- Please visit the online program homepage at <http://moodle.lattc.edu> prior to the start of class for directions, or see pages 82-84 of this schedule for more information.

**COMPUTER APPLICATIONS OFFICE TECHNOLOGIES 098 3.00 UNITS
MICROCOMPUTER OFFICE APPLICATIONS: INTRO TO WINDOWS FOR OA**
Evening Class

3049 lec 6:00pm - 7:05pm TTh P.A. TAYLOR K 210
& lab 7:05pm - 8:35pm TTh P.A. TAYLOR K 210

**COMPUTER APPLICATIONS OFFICE TECHNOLOGIES 134 1.50 UNITS
HOW TO TEACH AN ONLINE COURSE**

7960 lec 4:15 hrs/wk TBA - J.D. PERRET ON LINE
(7 Week Class - Starts 10/4/2010, Ends 11/15/2010)

- **Highly Recommended in-class Orientation:** Friday, 10/1/10, 6:00 pm - 8:00 pm, Room K-208
- Please visit the online program homepage at <http://moodle.lattc.edu> prior to the start of class for directions, or see pages 82-84 of this schedule for more information.

COMPUTER INFORMATION SYSTEMS

COMPUTER INFORMATION SYSTEMS 011 NETWORK SECURITY FUNDAMENTALS (CSU) 3.00 UNITS

0160	lec	8:00am - 10:10am	S	W.V. TEE	K 307
&	lab	10:10am - 12:20pm	S	W.V. TEE	K 307

COMPUTER INFORMATION SYSTEMS 035 MULTIMEDIA PRESENTATIONS FOR THE INTERNET I (CSU) 3.00 UNITS

0162	lec	7:00am - 7:50am	TTh	J. AUCIELLO	K 302
&	lab	7:50am - 9:10am	TTh	J. AUCIELLO	K 302

COMPUTER INFORMATION SYSTEMS 040 BEGINNING LEVEL PROGRAMMING/COMPUTER GAMES 3.00 UNITS

Evening Class

3033	lec	6:00pm - 8:05pm	M	B.C. OZUAH	K 305
&	lab	10:10am - 12:10pm	S	B.C. OZUAH	K 305

COMPUTER INFORMATION SYSTEMS 042 VIDEO GAME PROGRAMMING I 3.00 UNITS

Evening Class

3035	lec	6:00pm - 8:05pm	Th	W. HAMILTON	K 304
&	lab	8:05am - 10:00am	S	W. HAMILTON	K 304

COMPUTER INFORMATION SYSTEMS 700 COMPUTER CONCEPTS (CSU) 3.00 UNITS

0151	lec	12:00pm - 1:05pm	MW	L.M. HAHNE	K 307
&	lab	1:05pm - 2:05pm	MW	L.M. HAHNE	K 307

Evening Class

3025	lec	6:00pm - 9:05pm	T	J.D. CRUNKLETON	K 320
&	lab	1:05 hrs/wk TBA	-	J.D. CRUNKLETON	K 320

COMPUTER INFORMATION SYSTEMS 701 INTRODUCTION TO COMPUTERS AND THEIR USES (UC:CSU) 3.00 UNITS

0156	lec	7:00am - 7:30am	TTh	L.M. HAHNE	K 307
&	lab	7:30am - 9:10am	TTh	L.M. HAHNE	K 307
0158	lec	9:15am - 10:20am	MW	L.M. HAHNE	K 307
&	lab	10:20am - 11:20am	MW	L.M. HAHNE	K 307

Evening Class

3027	lec	6:00pm - 9:05pm	W	E.L. PROCTOR	K 305
&	lab	1:05 hrs/wk TBA	-	E.L. PROCTOR	K 305

COMPUTER INFORMATION SYSTEMS 702 BEGINNING MICROCOMPUTER SKILLS 1.00 UNIT

0140	lab	3:25 hrs/wk TBA	-	J. AUCIELLO	K 302
------	-----	-----------------	---	-------------	-------

COMPUTER INFORMATION SYSTEMS 709 OBJECT-ORIENTED PROGRAMMING LOGIC (UC:CSU) 3.00 UNITS

Evening Class

3031	lec	6:00pm - 9:15pm	Th	G.W. PHILLIPS	K 305
&	lab	1:05 hrs/wk TBA	-	G.W. PHILLIPS	K 305

COMPUTER INFORMATION SYSTEMS 733 MICROCOMPUTER DATABASE PROGRAMMING (CSU) 3.00 UNITS

0161	lec	8:00am - 10:10am	F	D.W. MOORE	K 307
&	lab	10:10am - 12:20pm	F	D.W. MOORE	K 307

COMPUTER INFORMATION SYSTEMS 739 PROGRAMMING IN C++ (UC:CSU) 3.00 UNITS

0166	lec	9:15am - 10:20am	TTh	L.M. HAHNE	K 307
&	lab	10:20am - 11:25am	TTh	L.M. HAHNE	K 307

COMPUTER INFORMATION SYSTEMS 757 XHTML PROGRAMMING AND APPLICATIONS (CSU) 3.00 UNITS

0172	lec	9:15am - 10:20am	TTh	J. AUCIELLO	K 302
&	lab	10:20am - 11:20am	TTh	J. AUCIELLO	K 302

COMPUTER INFORMATION SYSTEMS 758 COMPUTER LITERACY (CSU) 3.00 UNITS

0164	lec	12:00pm - 1:25pm	TTh	J. AUCIELLO	K 302
------	-----	------------------	-----	-------------	-------

COMPUTER INFORMATION SYSTEMS 762 WEB SCRIPTING (CSU) 3.00 UNITS

0173	lec	7:00am - 8:05am	MW	L.M. HAHNE	K 307
&	lab	8:05am - 9:05am	MW	L.M. HAHNE	K 307

COOPERATIVE EDUCATION

COOPERATIVE EDUCATION 395 WORK EXPERIENCE - GENERAL I (CSU) 3.00 UNITS

See page 85 for detail and meeting times

9001	lab	4:25 hrs/wk TBA	-	C.L. ANDERSON	D 236
------	-----	-----------------	---	---------------	-------

COSMETOLOGY

COSMETOLOGY 035 SKIN THERAPY I 6.00 UNITS

7030	lec	12:30pm - 2:00pm	MT	L.G. LEY	F 235
&	lab	2:30pm - 6:00pm	MT	L.G. LEY	R 102
&	lec	12:30pm - 2:00pm	WTh	L.G. LEY	F 235
&	lab	2:30pm - 6:00pm	WTh	L.G. LEY	R 102
&	lec	12:30pm - 2:00pm	F	L.G. LEY	F 235
&	lab	2:30pm - 6:00pm	F	L.G. LEY	R 102

(8 Week Class - Starts 8/30/2010, Ends 10/22/2010)

COSMETOLOGY 036 SKIN THERAPY II 6.00 UNITS

Pre-requisite: COSMO 35.

7031	lec	12:30pm - 2:00pm	MT	L.G. LEY	F 235
&	lab	2:30pm - 6:00pm	MT	L.G. LEY	R 102
&	lec	12:30pm - 2:00pm	WTh	L.G. LEY	F 235
&	lab	2:30pm - 6:00pm	WTh	L.G. LEY	R 102
&	lec	12:30pm - 2:00pm	F	L.G. LEY	F 235
&	lab	2:30pm - 6:00pm	F	L.G. LEY	R 102

(7 Week Class - Starts 10/25/2010, Ends 12/15/2010)

**COSMETOLOGY 037
SKIN THERAPY III**

Prerequisite: COSMO 35, 36.

7032	lec	12:30pm - 2:00pm	MT	L.G. LEY	F 235
&	lab	2:30pm - 6:00pm	MT	L.G. LEY	R 102
&	lec	12:30pm - 2:00pm	WTh	L.G. LEY	F 235
&	lab	2:30pm - 6:00pm	WTh	L.G. LEY	R 102
&	lec	12:30pm - 2:00pm	F	L.G. LEY	F 235
&	lab	2:30pm - 6:00pm	F	L.G. LEY	R 102

(8 Week Class - Starts 8/30/2010, Ends 10/22/2010)

6.00 UNITS**COSMETOLOGY 038
SKIN THERAPY IV**

Prerequisite: COSMO 35, 36, 37.

7033	lec	12:30pm - 2:00pm	MT	L.G. LEY	F 235
&	lab	2:30pm - 6:00pm	MT	L.G. LEY	R 102
&	lec	12:30pm - 2:00pm	WTh	L.G. LEY	F 235
&	lab	2:30pm - 6:00pm	WTh	L.G. LEY	R 102
&	lec	12:30pm - 2:00pm	F	L.G. LEY	F 235
&	lab	2:30pm - 6:00pm	F	L.G. LEY	R 102

(7 Week Class - Starts 10/25/2010, Ends 12/15/2010)

6.00 UNITS**COSMETOLOGY 111
FRESHMAN COSMETOLOGY**

7000	lec	7:00am - 8:30am	MTW	L.H. CHEN	R 108
&	lab	9:00am - 2:10pm	MTW	L.H. CHEN	R 108
&	lab	7:00am - 8:30am	Th	L.H. CHEN	R 108
&	lab	9:00am - 11:00am	Th	L.H. CHEN	R 108
&	lab	11:00am - 2:10pm	Th	L.H. CHEN	R 108

(8 Week Class - Starts 8/30/2010, Ends 10/22/2010)

6.00 UNITS

7002	lec	7:00am - 8:30am	MTW	R.G. LOPEZ	R 100
&	lab	9:00am - 2:10pm	MTW	R.G. LOPEZ	R 100
&	lab	7:00am - 8:30am	Th	R.G. LOPEZ	R 100
&	lab	9:00am - 11:00am	Th	R.G. LOPEZ	R 100
&	lab	11:00am - 2:10pm	Th	R.G. LOPEZ	R 100

(8 Week Class - Starts 8/30/2010, Ends 10/22/2010)

7010	lec	2:30pm - 3:55pm	MT	R.M. NUNLEY	R 100
&	lab	4:30pm - 8:00pm	MT	R.M. NUNLEY	R 100
&	lec	2:30pm - 3:55pm	W	E.J. ROBINSON	R 100
&	lab	4:30pm - 8:00pm	W	E.J. ROBINSON	R 100
&	lec	2:30pm - 3:55pm	ThF	A.M. MYERS	R 100
&	lab	4:30pm - 8:00pm	ThF	A.M. MYERS	R 100

(8 Week Class - Starts 8/30/2010, Ends 10/22/2010)

Evening Class

4300	lec	4:30pm - 6:00pm	MT	D. MERCADO	R 108
&	lab	6:00pm - 9:30pm	MT	D. MERCADO	R 108
&	lec	4:30pm - 6:00pm	Th	S.A. WILLIAMS	R 108
&	lab	6:00pm - 9:30pm	Th	S.A. WILLIAMS	R 108
&	lab	7:00am - 10:00am	S	F. SMITH	R 108
&	lab	10:30am - 2:00pm	S	F. SMITH	R 108
&	lab	6:00pm - 9:30pm	W	S.A. WILLIAMS	R 108
&	lec	4:30pm - 6:00pm	W	S.A. WILLIAMS	R 108

(8 Week Class - Starts 8/30/2010, Ends 10/23/2010)

**COSMETOLOGY 112
JUNIOR SALON I**

Prerequisite: Cosmetology 111.

7001	lec	7:00am - 8:30am	MTW	L.H. CHEN	R 108
&	lab	9:00am - 2:10pm	MTW	L.H. CHEN	R 108
&	lab	7:00am - 8:30am	Th	L.H. CHEN	R 108
&	lab	9:00am - 11:00am	Th	L.H. CHEN	R 108
&	lab	11:00am - 2:10pm	Th	L.H. CHEN	R 108

(7 Week Class - Starts 10/25/2010, Ends 12/17/2010)

6.00 UNITS

7003	lec	7:00am - 8:30am	MTW	R.G. LOPEZ	R 100
&	lab	9:00am - 2:10pm	MTW	R.G. LOPEZ	R 100
&	lab	7:00am - 8:30am	Th	R.G. LOPEZ	R 100
&	lab	9:00am - 11:00am	Th	R.G. LOPEZ	R 100
&	lab	11:00am - 2:10pm	Th	R.G. LOPEZ	R 100

(7 Week Class - Starts 10/25/2010, Ends 12/17/2010)

7011	lec	2:30pm - 3:55pm	MT	R.M. NUNLEY	R 100
&	lab	4:30pm - 8:00pm	MT	R.M. NUNLEY	R 100
&	lec	2:30pm - 3:55pm	W	E.J. ROBINSON	R 100
&	lab	4:30pm - 8:00pm	W	E.J. ROBINSON	R 100
&	lec	2:30pm - 3:55pm	ThF	A.M. MYERS	R 100
&	lab	4:30pm - 8:00pm	ThF	A.M. MYERS	R 100

(7 Week Class - Starts 10/25/2010, Ends 12/18/2010)

Evening Class

4301	lec	4:30pm - 6:00pm	MT	D. MERCADO	R 108
&	lab	6:00pm - 9:30pm	MT	D. MERCADO	R 108
&	lec	4:30pm - 6:00pm	Th	S.A. WILLIAMS	R 108
&	lab	6:00pm - 9:30pm	Th	S.A. WILLIAMS	R 108
&	lab	7:00am - 10:00am	S	F. SMITH	R 108
&	lab	10:30am - 2:00pm	S	F. SMITH	R 108
&	lec	4:30pm - 6:00pm	W	S.A. WILLIAMS	R 108
&	lec	6:00pm - 9:30pm	W	S.A. WILLIAMS	R 108

(7 Week Class - Starts 10/25/2010, Ends 12/18/2010)

**COSMETOLOGY 121
JUNIOR SALON II**

Prerequisite: Cosmetology 112.

7004	lec	7:00am - 8:30am	MTW	E.J. ROBINSON	R 107
&	lab	9:00am - 2:10pm	MTW	E.J. ROBINSON	R 107
&	lab	7:00am - 8:30am	Th	E.J. ROBINSON	R 107
&	lab	9:00am - 11:00am	Th	E.J. ROBINSON	R 107
&	lab	11:00am - 2:10pm	Th	E.J. ROBINSON	R 107

(8 Week Class - Starts 8/30/2010, Ends 10/22/2010)

Evening Class

4302	lec	4:30pm - 6:00pm	MTWTh	C.P. YOUNG	R 106
&	lab	6:00pm - 9:30pm	MTWTh	C.P. YOUNG	R 106
&	lab	7:00am - 10:00am	S	C.P. YOUNG	R 106
&	lab	10:30am - 2:00pm	S	C.P. YOUNG	R 106

(8 Week Class - Starts 8/30/2010, Ends 10/23/2010)

**COSMETOLOGY 122
JUNIOR SALON III**

Prerequisite: Cosmetology 121.

7005	lec	7:00am - 8:30am	MTW	E.J. ROBINSON	R 107
&	lab	9:00am - 2:10pm	MTW	E.J. ROBINSON	R 107
&	lab	7:00am - 8:30am	Th	E.J. ROBINSON	R 107
&	lab	9:00am - 11:00am	Th	E.J. ROBINSON	R 107
&	lab	11:00am - 2:10pm	Th	E.J. ROBINSON	R 107

(7 Week Class - Starts 10/25/2010, Ends 12/17/2010)

6.00 UNITS

Evening Class

4303	lec	4:30pm - 6:00pm	MTWTh	J.V. MONGE	R 106
&	lab	6:30pm - 9:30pm	MTWTh	J.V. MONGE	R 106
&	lab	7:00am - 10:00am	S	J.V. MONGE	R 106
&	lab	10:30am - 2:00pm	S	J.V. MONGE	R 106

(7 Week Class - Starts 10/25/2010, Ends 12/18/2010)

COSMETOLOGY 131 6.00 UNITS**TINTING I**

Prerequisite: Cosmetology 112.

7006	lec	7:00am - 8:30am	MTW	S. SHACKELFORD	R 106
&	lab	9:00am - 2:10pm	MTW	S. SHACKELFORD	R 106
&	lab	7:00am - 8:30am	Th	S. SHACKELFORD	R 106
&	lab	9:00am - 11:00am	Th	S. SHACKELFORD	R 106
&	lab	11:00am - 2:10pm	Th	S. SHACKELFORD	R 106

(8 Week Class - Starts 8/30/2010, Ends 10/22/2010)

COSMETOLOGY 132 6.00 UNITS**TINTING II**

Prerequisite: Cosmetology 131.

7007	lec	7:00am - 8:30am	MTW	S. SHACKELFORD	R 106
&	lab	9:00am - 2:10pm	MTW	S. SHACKELFORD	R 106
&	lab	7:00am - 8:30am	Th	S. SHACKELFORD	R 106
&	lab	9:00am - 11:00am	Th	S. SHACKELFORD	R 106
&	lab	11:00am - 2:10pm	Th	S. SHACKELFORD	R 106

(7 Week Class - Starts 10/25/2010, Ends 12/17/2010)

COSMETOLOGY 141 6.00 UNITS**SENIOR SALON I**

Prerequisite: Cosmetology 122, 132.

7008	lec	7:00am - 8:30am	MT	M.K. MAINE	R 101
&	lab	9:00am - 2:10pm	MT	M.K. MAINE	R 101
&	lab	7:00am - 8:30am	Th	E. ROCK	R 101
&	lab	9:00am - 2:10pm	Th	E. ROCK	R 101
&	lec	7:00am - 8:30am	W	STAFF	R 101
&	lec	9:00am - 2:10pm	W	STAFF	R 101

(8 Week Class - Starts 8/30/2010, Ends 10/22/2010)

Evening Class

4306	lec	4:30pm - 6:00pm	MTWTh	C.P. YOUNG	R 107
&	lab	6:00pm - 9:30pm	MTWTh	C.P. YOUNG	R 107
&	lab	7:00am - 10:00am	S	C.P. YOUNG	R 107
&	lab	10:30am - 2:00pm	S	C.P. YOUNG	R 107

(8 Week Class - Starts 8/30/2010, Ends 10/23/2010)

COSMETOLOGY 142 6.00 UNITS**SENIOR SALON II**

Prerequisite: Cosmetology 141.

7009	lec	7:00am - 8:30am	MT	M.K. MAINE	R 101
&	lab	9:00am - 2:10pm	MT	M.K. MAINE	R 101
&	lab	7:00am - 8:30am	Th	E. ROCK	R 101
&	lab	9:00am - 2:10pm	Th	E. ROCK	R 101
&	lec	7:00am - 8:30am	W	STAFF	R 101
&	lab	9:00am - 2:10pm	W	STAFF	R 101

(7 Week Class - Starts 10/25/2010, Ends 12/17/2010)

Evening Class

4307	lec	4:30pm - 6:00pm	MTWTh	J.V. MONGE	R 107
&	lab	6:00pm - 9:30pm	MTWTh	J.V. MONGE	R 107
&	lab	7:00am - 10:00am	S	J.V. MONGE	R 107
&	lab	10:30am - 2:00pm	S	J.V. MONGE	R 107

(7 Week Class - Starts 10/25/2010, Ends 12/18/2010)

COSMETOLOGY 222 3.00 UNITS
INTRODUCTION TO SPECIAL EFFECTS MAKEUP TECHNIQUES**Evening Class**

4305	lec	4:30pm - 5:20pm	MT	STAFF	H 354
&	lab	5:20pm - 9:35pm	MT	STAFF	H 354

(5 Week Class - Starts 9/13/2010, Ends 10/14/2010)

CULINARY ARTS**CULINARY ARTS 100 2.00 UNITS**
INTRODUCTION TO CULINARY ARTS (CSU)

7520	lec	7:00am - 9:15am	F	J.K. KANEMAKI	H 132
&	lab	9:15am - 1:25pm	F	J.K. KANEMAKI	H 117

(8 Week Class - Starts 8/30/2010, Ends 10/22/2010)

7521	lec	7:00am - 9:20am	F	J.M. LISANTI	H 132
&	lab	9:20am - 2:25pm	F	J.M. LISANTI	H 107

(6 Week Class - Starts 10/29/2010, Ends 12/16/2010)

CULINARY ARTS 111 4.00 UNITS
CULINARY ARTS ORIENTATION I (CSU)

Pre/corequisite: Cul Art 112

7500	lec	7:00am - 9:00am	TWTh	R.T. SPENCE	H 236
&	lab	9:00am - 12:40pm	TWTh	R.T. SPENCE	H 102

(8 Week Class - Starts 8/30/2010, Ends 10/22/2010)

7503	lec	7:00am - 9:00am	TWTh	STAFF	H 236
&	lab	9:00am - 12:50pm	TWTh	STAFF	H 102

(8 Week Class - Starts 10/25/2010, Ends 12/16/2010)

7504	lec	2:00pm - 4:05pm	TTh	D. WARRINER	H 132
&	lab	4:05pm - 6:20pm	TTh	D. WARRINER	H 107

(16 Week Class - Starts 8/30/2010, Ends 12/16/2010)

7523	lec	1:30pm - 2:50pm	TWTh	J.M. LISANTI	H 119
&	lab	2:55pm - 7:55pm	TWTh	J.M. LISANTI	H 102

(8 Week Class - Starts 10/25/2010, Ends 12/16/2010)

CULINARY ARTS 112 2.00 UNITS
Sanitation and Safety (CSU)

7501	lec	7:10am - 9:25am	MW	D. SCHERER	H 103
------	-----	-----------------	----	------------	-------

(8 Week Class - Starts 10/25/2010, Ends 12/16/2010)

7502	lec	7:20am - 9:30am	MW	G. DELROSARIO	H 103
------	-----	-----------------	----	---------------	-------

(8 Week Class - Starts 8/30/2010, Ends 10/22/2010)

7505	lec	2:00pm - 4:05pm	MW	S.B. FEIGENBAUM	H 132
------	-----	-----------------	----	-----------------	-------

(8 Week Class - Starts 8/30/2010, Ends 10/22/2010)

7526	lec	2:15pm - 4:25pm	TTh	G. DELROSARIO	H 301
------	-----	-----------------	-----	---------------	-------

(8 Week Class - Starts 10/26/2010, Ends 12/19/2010)

7531	lec	2:10pm - 4:15pm	MW	S.B. FEIGENBAUM	H 132
------	-----	-----------------	----	-----------------	-------

(8 Week Class - Starts 10/25/2010, Ends 12/16/2010)

7551	lec	4:20pm - 6:30pm	MW	S.B. FEIGENBAUM	H 132
------	-----	-----------------	----	-----------------	-------

(8 Week Class - Starts 8/30/2010, Ends 10/20/2010)

7553	lec	4:25pm - 6:25pm	MW	S.B. FEIGENBAUM	H 132
------	-----	-----------------	----	-----------------	-------

(8 Week Class - Starts 10/25/2010, Ends 12/19/2010)

CULINARY ARTS 120
FRONT OF HOUSE/DINING SERVICES

4.00 UNITS

7524	lec	9:40am - 10:40am	MTWTh	G. DELROSARIO	H 103
&	lab	10:40am - 2:05pm	MTWTh	G. DELROSARIO	H 103
<i>(8 Week Class - Starts 8/30/2010, Ends 10/22/2010)</i>					
7525	lec	9:35am - 10:35am	MTWTh	D. SCHERER	H 103
&	lab	10:35am - 2:00pm	MTWTh	D. SCHERER	H 109
<i>(8 Week Class - Starts 10/25/2010, Ends 12/16/2010)</i>					

CULINARY ARTS 121
GARDE MANGER I - BAKING (CSU)

6.00 UNITS

7506	lab	6:30am - 10:05am	MTWTh	L.S. BLANCHARD	H 107
&	lec	10:05am - 12:10pm	MTWTh	L.S. BLANCHARD	H 119
<i>(8 Week Class - Starts 8/30/2010, Ends 10/22/2010)</i>					
7509	lab	6:30am - 10:05am	MTWTh	L.S. BLANCHARD	H 107
&	lec	10:05am - 12:15pm	MTWTh	L.S. BLANCHARD	H 119
<i>(8 Week Class - Starts 10/25/2010, Ends 12/16/2010)</i>					
7518	lab	2:00pm - 5:40pm	TTh	L.S. BLANCHARD	H 107
&	lec	5:40pm - 7:40pm	TTh	L.S. BLANCHARD	H 119
<i>(16 Week Class - Starts 8/30/2010, Ends 12/16/2010)</i>					

CULINARY ARTS 122
GARDE MANGER II - CHARCUTIERE (CSU)

6.00 UNITS

7507	lec	8:00am - 10:05am	MTWTh	J.A. VACHON	H 119
&	lab	10:05am - 1:55pm	MTWTh	J.A. VACHON	H 107
<i>(8 Week Class - Starts 10/25/2010, Ends 12/16/2010)</i>					
7508	lec	7:30am - 9:30am	MTWTh	J.A. VACHON	H 119
&	lab	9:30am - 1:05pm	MTWTh	J.A. VACHON	H 107
<i>(8 Week Class - Starts 8/30/2010, Ends 10/22/2010)</i>					
7519	lab	2:00pm - 5:40pm	MW	J.A. VACHON	H 107
&	lec	5:40pm - 7:40pm	MW	J.A. VACHON	H 301
<i>(16 Week Class - Starts 8/30/2010, Ends 12/16/2010)</i>					

CULINARY ARTS 131
CULINARY ARTS - BREAKFAST I (CSU)

6.00 UNITS

7510	lab	6:30am - 10:10am	MTWTh	S.B. FEIGENBAUM	H 107
&	lec	10:10am - 12:10pm	MTWTh	S.B. FEIGENBAUM	H 132
<i>(8 Week Class - Starts 8/30/2010, Ends 10/22/2010)</i>					
7513	lab	6:30am - 10:10am	MTWTh	S.B. FEIGENBAUM	H 107
&	lec	10:10am - 12:10pm	MTWTh	S.B. FEIGENBAUM	H 132
<i>(8 Week Class - Starts 10/25/2010, Ends 12/16/2010)</i>					

CULINARY ARTS 132
CULINARY ARTS - ENTREMETIER, SAUCIER (CSU)

6.00 UNITS

7511	lec	7:30am - 9:30am	MTWTh	J.K. KANEMAKI	H 301
&	lab	9:30am - 1:10pm	MTWTh	J.K. KANEMAKI	H 107
<i>(8 Week Class - Starts 10/25/2010, Ends 12/16/2010)</i>					
7512	lec	7:30am - 9:30am	MTWTh	J.K. KANEMAKI	H 301
&	lab	9:30am - 1:10pm	MTWTh	J.K. KANEMAKI	H 107
<i>(8 Week Class - Starts 8/30/2010, Ends 10/22/2010)</i>					

CULINARY ARTS 141
ADVANCED RESTAURANT PRACTICES I (CSU)

6.00 UNITS

7514	lec	7:15am - 9:15am	MTWTh	S.L. KASMAR	H 132
&	lab	9:15am - 12:55pm	MTWTh	S.L. KASMAR	H 107
<i>(8 Week Class - Starts 8/30/2010, Ends 10/22/2010)</i>					
7517	lec	7:15am - 9:15am	MTWTh	G. DELROSARIO	H 132
&	lab	9:15am - 1:05pm	MTWTh	G. DELROSARIO	H 107
<i>(8 Week Class - Starts 10/25/2010, Ends 12/16/2010)</i>					

CULINARY ARTS 142
ADVANCED RESTAURANT PRACTICES II (CSU)

6.00 UNITS

7515	lab	6:45am - 10:25am	MTWTh	W.R. SHARP	H 107
&	lec	10:25am - 12:45pm	MTWTh	W.R. SHARP	H 109
<i>(8 Week Class - Starts 10/25/2010, Ends 12/16/2010)</i>					
7532	lab	6:45am - 10:20am	MTWTh	J.M. LISANTI	H 107
&	lec	10:25am - 12:30pm	MTWTh	J.M. LISANTI	H 109
<i>(8 Week Class - Starts 8/30/2010, Ends 10/22/2010)</i>					

CULINARY ARTS 170
CULINARY NUTRITION (CSU)

2.00 UNITS

7516	lec	2:30pm - 3:20pm	MW	R.T. SPENCE	H 103
&	lec	3:20pm - 5:25pm	MW	R.T. SPENCE	H 102
<i>(8 Week Class - Starts 8/30/2010, Ends 10/21/2010)</i>					
7534	lec	7:00am - 9:20am	M	R.T. SPENCE	H 236
&	lec	9:20am - 2:20pm	M	R.T. SPENCE	H 102
<i>(7 Week Class - Starts 8/30/2010, Ends 10/22/2010)</i>					
7537	lec	7:00am - 9:10am	M	R.T. SPENCE	H 236
&	lec	9:10am - 1:10pm	M	R.T. SPENCE	H 102
<i>(7 Week Class - Starts 10/25/2010, Ends 12/16/2010)</i>					

CULINARY ARTS 941
COOPERATIVE EDUCATION - CULINARY ARTS

4.00 UNITS

See page 85 for detail and meeting times

9044	lec	4:15 hrs/wk TBA	-	C.A. MORLEY MOWER	D 236
------	-----	-----------------	---	-------------------	-------

DIESEL AND RELATED TECHNOLOGY

DIESEL AND RELATED TECHNOLOGY 112
DIESEL ENGINE FUNDAMENTALS

11.00 UNITS

7400	lec	7:00am - 8:05am	MTWTh	C.A. ROJAS	F 118
&	lab	8:05am - 12:20pm	MTWTh	C.A. ROJAS	F 118

DIESEL AND RELATED TECHNOLOGY 122
DIESEL FUEL SYSTEMS AND ELECTRIC COMPONENT THEORY

11.00 UNITS

7402	lec	7:00am - 8:05am	MTWTh	J. GUERRA	F 126
&	lab	8:05am - 12:20pm	MTWTh	J. GUERRA	F 126

DIESEL AND RELATED TECHNOLOGY 142
DIESEL ENGINE OVERHAUL FUNDAMENTALS

11.00 UNITS

7410	lec	7:00am - 8:05am	MTWTh	J.M. CAVANAUGH	F 100
&	lab	8:05am - 12:20pm	MTWTh	J.M. CAVANAUGH	F 100

DIESEL AND RELATED TECHNOLOGY 148
TRUCK AIR & HYDRAULIC BRAKE SYSTEM THEORY AND REPAIR

3.00 UNITS

Evening Class

4453	lec	6:00pm - 7:00pm	TTh	J.M. CAVANAUGH	F 100
&	lab	7:00pm - 9:25pm	TTh	J.M. CAVANAUGH	F 100

**DIESEL AND RELATED TECHNOLOGY 264
HEAVY DUTY DRIVE TRAIN** 4.00 UNITS**Evening Class**

4506	lec	7:30am - 8:35am	S	C.A. ROJAS	F 100
&	lab	8:45am - 2:05pm	S	C.A. ROJAS	F 100

**DIESEL AND RELATED TECHNOLOGY 265
HEAVY DUTY ELECTRONIC SYSTEMS** 4.00 UNITS**Evening Class**

4450	lec	6:00pm - 7:00pm	MW	J.R. DROUIN	F 100
&	lab	7:00pm - 9:25pm	MW	J.R. DROUIN	F 100

**DIESEL AND RELATED TECHNOLOGY 941
COOPERATIVE EDUCATION - DIESEL AND RELATED TECHNOLOGY** 4.00 UNITS

See page 85 for detail and meeting times

9236	lec	4:25 hrs/wk TBA	-	C.A. MORLEY MOWER	D 236
------	-----	-----------------	---	-------------------	-------

DIGITAL MEDIA**DIGITAL MEDIA 100
INTRODUCTION TO DIGITAL VIDEO (CSU)** 3.00 UNITS**Evening Class**

4361	lec	6:00pm - 7:15pm	MW	J. GUERRIERI	H 220
&	lab	7:15pm - 8:30pm	MW	J. GUERRIERI	H 220

**DIGITAL MEDIA 101
FUNDAMENTALS OF MASS MEDIA** 3.00 UNITS

7227	lec	9:00am - 12:25pm	S	J. GUERRIERI	H 220
------	-----	------------------	---	--------------	-------

**DIGITAL MEDIA 103
FUNDAMENTAL OF DIGITAL AUDIO (CSU)** 3.00 UNITS**Evening Class**

4362	lec	6:00pm - 7:15pm	TTh	P.W. REED	H 220
&	lab	7:15pm - 8:30pm	TTh	P.W. REED	H 220

**DIGITAL MEDIA 199
DIGITAL MEDIA LAB** 1.00 UNIT**Evening Class**

4363	lab	4:40pm - 5:50pm	TTh	P.W. REED	H 220
------	-----	-----------------	-----	-----------	-------

DRAFTING**DRAFTING 060
CAD INTRODUCTION (UC:CSU)** 3.00 UNITS

8004	lec	10:00am - 11:35am	F	D.E. FREELAND	D 331
&	lab	11:35am - 3:15pm	F	D.E. FREELAND	D 331

**DRAFTING 062
CAD FOR ARCHITECTS (CSU)** 3.00 UNITS

8001	lec	9:45am - 10:50am	TTh	E.A. GARCIA	D 303
&	lab	10:50am - 12:20pm	TTh	E.A. GARCIA	D 303

ECONOMICS**ECONOMICS 001
PRINCIPLES OF ECONOMICS I (UC:CSU)** 3.00 UNITS

0184	lec	11:45am - 1:10pm	MW	J. AHMAD	K 321
------	-----	------------------	----	----------	-------

Evening Class

3036	lec	6:00pm - 9:15pm	M	J. AHMAD	K 321
------	-----	-----------------	---	----------	-------

Economic 1 is also offered through Instructional Television (ITV) Program. For registration and orientation, see Ad on page 87

**ECONOMICS 002
PRINCIPLES OF ECONOMICS II (UC:CSU)** 3.00 UNITS

0185	lec	10:10am - 11:35am	TTh	J. AHMAD	K 321
------	-----	-------------------	-----	----------	-------

0186	lec	10:10am - 11:35am	MW	J. AHMAD	K 321
------	-----	-------------------	----	----------	-------

EDUCATION**EDUCATION 006
METHODS AND MATERIALS OF TUTORING** 1.00 UNIT

0416	lab	3:10 hrs/wk TBA	-	A.K. RANDALL	C 102
------	-----	-----------------	---	--------------	-------

**ELECTRICAL CONSTRUCTION
AND MAINTENANCE****ELECTRICAL CONSTRUCTION & MAINTENANCE 001
FUNDAMENTALS OF ELECTRICITY** 3.00 UNITS

8330	lec	12:00pm - 1:25pm	MW	J.B. LESTER	B 301
------	-----	------------------	----	-------------	-------

**ELECTRICAL CONSTRUCTION & MAINTENANCE 006
SECURITY AND FIRE ALARM TECHNICIAN CERTIFICATION** 3.00 UNITS**Evening Class**

4707	lec	6:00pm - 6:50pm	MW	D.S. ROBINSON	B 351
------	-----	-----------------	----	---------------	-------

&	lab	6:50pm - 9:10pm	MW	D.S. ROBINSON	B 351
---	-----	-----------------	----	---------------	-------

**ELECTRICAL CONSTRUCTION & MAINTENANCE 007
HOME THEATER & COMMERCIAL AUDIO, VIDEO INSTALLATION
THEORY AND PRACTICES** 3.00 UNITS**Evening Class**

4758	lec	6:00pm - 7:05pm	TTh	M.H. ZELAYA	B 351
------	-----	-----------------	-----	-------------	-------

&	lab	7:05pm - 9:40pm	TTh	M.H. ZELAYA	B 351
---	-----	-----------------	-----	-------------	-------

**ELECTRICAL CONSTRUCTION & MAINTENANCE 100
(O.S.H.A.) SAFETY STANDARDS: CONSTRUCTION & INDUSTRY** 2.00 UNITS

8000	lec	2:30pm - 4:40pm	Th	J.R. OLSZEWSKI	F 208
------	-----	-----------------	----	----------------	-------

8130	lec	8:00am - 10:00am	W	M.D. ROGERS	TE 111
------	-----	------------------	---	-------------	--------

Evening Class

4615	lec	6:00pm - 8:10pm	Th	J.R. OLSZEWSKI	F 208
------	-----	-----------------	----	----------------	-------

**ELECTRICAL CONSTRUCTION & MAINTENANCE 101
ELECTRICAL CRAFT HELPER****4.00 UNITS****Evening Classes**

4723	lec	5:30pm - 9:45pm	Th	R.E. IADEVAIA	D 301
4842	lec	5:00pm - 9:15pm	T	G.M. WAID	EDM TRAN
• EDM Training Facility, 1760 Truedate Street, Sun Valley 91352					
4843	lec	5:00pm - 9:15pm	W	G.M. WAID	EDM TRAN
• EDM Training Facility, 11760 Truedate Street, Sun Valley 91352					
4844	lec	5:30pm - 9:45pm	W	D.E. POPLAWSKI	CETR DIST
• Central District Headquarters, 1350 Wall Street, Los Angeles, California 90015					
4847	lec	5:00pm - 9:15pm	Th	G.M. WAID	EDM TRAN
• EDM Training Facility, 11760 Truedate Street, Sun Valley 91352					
4856	lec	5:30pm - 10:00pm	Th	D.E. POPLAWSKI	CETR DIST
• Central District Headquarters, 1350 Wall Street, Los Angeles, California 90015					

**ELECTRICAL CONSTRUCTION & MAINTENANCE 105
FUNDAMENTALS OF SOLAR ELECTRICITY****3.00 UNITS**

6973	lec	8:30am - 12:45pm	S	B. GOLUZA	F 208
8334	lec	2:30pm - 5:40pm	F	B. GOLUZA	F 208

Evening Class

4862	lec	6:00pm - 9:10pm	F	B. GOLUZA	F 208
------	-----	-----------------	---	-----------	-------

**ELECTRICAL CONSTRUCTION & MAINTENANCE 115
FUNDAMENTALS OF D.C. ELECTRICITY****3.00 UNITS**

8122	lec	7:00am - 8:25am	TTh	D.C. BURKE	B 353
8126	lec	7:00am - 8:25am	TTh	D.S. ROBINSON	B 301

Evening Classes

4708	lec	6:00pm - 9:10pm	F	R.E. JACKSON	B 352
4709	lec	6:00pm - 9:10pm	M	D.A. SUSSMAN	D 325
4710	lec	6:00pm - 9:10pm	W	STAFF	B 250

**ELECTRICAL CONSTRUCTION & MAINTENANCE 116
HANDTOOLS AND WIRING PRACTICES****2.00 UNITS**

8123	lab	7:00am - 1:30pm	F	D.C. BURKE	B 353
8127	lab	7:00am - 1:30pm	F	D.S. ROBINSON	B 301

Evening Classes

4712	lab	6:00pm - 9:10pm	TTh	D.C. BURKE	B 353
4859	lab	6:00pm - 9:20pm	WF	R.E. IADEVAIA	B 353

**ELECTRICAL CONSTRUCTION & MAINTENANCE 117
ELEMENTARY CIRCUIT PRACTICES****4.00 UNITS**

8124	lab	8:35am - 11:45am	MTWTh	D.C. BURKE	B 353
8128	lab	8:35am - 11:45am	MTWTh	D.S. ROBINSON	B 301

**ELECTRICAL CONSTRUCTION & MAINTENANCE 119
ELECTRICAL CONSTRUCTION & MAINTENANCE****3.00 UNITS**

8125	lec	7:00am - 8:25am	MW	D.C. BURKE	B 353
8129	lec	7:00am - 8:25am	MW	D.S. ROBINSON	B 301
8303	lec	10:20am - 1:30pm	M	W.D. ELARTON	B 250

**ELECTRICAL CONSTRUCTION & MAINTENANCE 120
INDUSTRIAL CONTROL SYSTEMS****3.00 UNITS**

8136	lec	10:45am - 12:10pm	MT	J.B. LESTER	B 331
8140	lec	9:00am - 10:25am	MT	M.D. ROGERS	F 208

Evening Class

4713	lec	6:00pm - 9:10pm	M	C.R. WIEGAND	B 336
------	-----	-----------------	---	--------------	-------

**ELECTRICAL CONSTRUCTION & MAINTENANCE 128
INDUSTRIAL CONTROL SYSTEMS PRACTICES****3.00 UNITS**

Development and application of control circuitry.

8137	lab	7:00am - 9:20am	MTThF	J.B. LESTER	B 330
8141	lab	10:45am - 12:50pm	MTWThF	M.D. ROGERS	B 330

**ELECTRICAL CONSTRUCTION & MAINTENANCE 128A
INDUSTRIAL CONTROL SYSTEMS PRACTICES A****1.00 UNIT****Evening Classes**

4714	lab	6:00pm - 9:10pm	M	J.L. SEITZ	B 330
4715	lab	6:00pm - 9:10pm	W	J.L. SEITZ	B 330

**ELECTRICAL CONSTRUCTION & MAINTENANCE 128B
INDUSTRIAL CONTROL SYSTEMS PRACTICES B****1.00 UNIT****Evening Classes**

4716	lab	6:00pm - 9:10pm	M	J.L. SEITZ	B 330
4717	lab	6:00pm - 9:10pm	W	J.L. SEITZ	B 330

**ELECTRICAL CONSTRUCTION & MAINTENANCE 128C
INDUSTRIAL CONTROL SYSTEMS PRACTICES C****1.00 UNIT****Evening Classes**

4718	lab	6:00pm - 9:10pm	M	J.L. SEITZ	B 330
4719	lab	6:00pm - 9:10pm	W	J.L. SEITZ	B 330

**ELECTRICAL CONSTRUCTION & MAINTENANCE 129
FUNDAMENTALS OF ALTERNATING CURRENT****3.00 UNITS**

8138	lec	10:45am - 12:10pm	ThF	J.B. LESTER	B 331
8142	lec	9:10am - 10:45am	ThF	M.D. ROGERS	F 208

Evening Classes

4720	lec	6:00pm - 9:10pm	F	D.A. SUSSMAN	B 302
4732	lec	6:00pm - 9:10pm	T	M.D. ROGERS	F 150

**ELECTRICAL CONSTRUCTION & MAINTENANCE 130
PRINCIPLES OF INDUSTRIAL ELECTRIC POWER****3.00 UNITS**

8144	lec	10:20am - 11:35am	MW	H. UCHIDA	C 201
8149	lec	8:45am - 10:10am	MW	T.G. NIEVES	B 302

**ELECTRICAL CONSTRUCTION & MAINTENANCE 136
INDUSTRIAL POWER APPLICATIONS****3.00 UNITS**

8145	lab	7:00am - 10:10am	MWF	H. UCHIDA	B 304
8150	lab	10:10am - 1:20pm	MWF	T.G. NIEVES	B 304

**ELECTRICAL CONSTRUCTION & MAINTENANCE 137
INDUSTRIAL ELECTRONIC CONTROL SYSTEMS****3.00 UNITS**

8146	lec	10:10am - 11:35am	TTh	H. UCHIDA	C 201
8151	lec	8:45am - 10:10am	TTh	T.G. NIEVES	B 304

**ELECTRICAL CONSTRUCTION & MAINTENANCE 138
APPLICATIONS OF ELECTRICAL AND ELECTRONICS DEVICES****2.00 UNITS**

8147	lab	7:00am - 10:10am	TTh	H. UCHIDA	B 304
8152	lab	10:10am - 1:20pm	TTh	T.G. NIEVES	B 302

**ELECTRICAL CONSTRUCTION & MAINTENANCE 140
CONSTRUCTION WIRING PRINCIPLES AND PRACTICES****3.00 UNITS**

8154	lec	10:10am - 11:35am	MF	R.E. JACKSON	B 352
8159	lec	10:10am - 11:35am	MF	R.E. JACKSON	B 336

**ELECTRICAL CONSTRUCTION & MAINTENANCE 142
BASIC PROGRAMMABLE LOGIC CONTROLS (PLC)****1.00 UNIT**

8148	lab	11:40am - 1:05pm	TTh	H. UCHIDA	C 201
8153	lab	7:00am - 10:10am	F	T.G. NIEVES	C 201

**ELECTRICAL CONSTRUCTION & MAINTENANCE 150
INTRODUCTION TO THE ELECTRICAL CODES****3.00 UNITS**

8155	lec	10:10am - 11:35am	TW	R.E. JACKSON	B 336
8160	lec	10:10am - 11:35am	TW	R.E. JACKSON	B 351

**ELECTRICAL CONSTRUCTION & MAINTENANCE 167
ELECTRICAL CONSTRUCTION WIRING TECHNIQUES****3.00 UNITS**

8156	lab	7:00am - 10:10am	MWF	R.E. JACKSON	B 337
8161	lab	7:00am - 10:10am	MWF	L.D. POGOLER	B 337

**ELECTRICAL CONSTRUCTION & MAINTENANCE 168
INSTALLATION OF ELECTRICAL WIRING****2.00 UNITS**

8157	lab	7:00am - 10:10am	TTh	R.E. JACKSON	B 337
8162	lab	7:00am - 10:10am	TTh	L.D. POGOLER	B 337

**ELECTRICAL CONSTRUCTION & MAINTENANCE 169
ALTERNATING CURRENT PRACTICES****2.00 UNITS**

8139	lab	9:20am - 10:45am	MTThF	J.B. LESTER	B 330
8143	lab	12:50pm - 2:00pm	MTWThF	M.D. ROGERS	B 330

**ELECTRICAL CONSTRUCTION & MAINTENANCE 171
ELECTRICAL CODES AND ORDINANCES I****3.00 UNITS****Evening Classes**

4724	lec	6:00pm - 9:10pm	M	R.T. TAKIGUCHI	B 352
4760	lec	6:00pm - 9:10pm	F	J.M. DOMINGUEZ	B 301

**ELECTRICAL CONSTRUCTION & MAINTENANCE 172
ELECTRICAL CODES AND ORDINANCES II****3.00 UNITS****Evening Class**

4725	lec	6:00pm - 9:10pm	M	W.D. ELARTON	B 353
------	-----	-----------------	---	--------------	-------

**ELECTRICAL CONSTRUCTION & MAINTENANCE 173
ELECTRICAL MATHEMATICS I****3.00 UNITS****Evening Class**

4726	lec	6:00pm - 9:10pm	T	N.G. KARTHAS	B 352
------	-----	-----------------	---	--------------	-------

**ELECTRICAL CONSTRUCTION & MAINTENANCE 174
ELECTRICAL MATHEMATICS II****3.00 UNITS**

8307	lec	10:20am - 1:30pm	F	C.J. BARNETT	B 233
------	-----	------------------	---	--------------	-------

Evening Class

4728	lec	6:00pm - 9:10pm	M	N.G. KARTHAS	B 302
------	-----	-----------------	---	--------------	-------

**ELECTRICAL CONSTRUCTION & MAINTENANCE 177
ELECTRIC MOTOR CONTROL I****3.00 UNITS****Evening Class**

4729	lec	6:00pm - 9:10pm	M	R. WINSTON	B 320
------	-----	-----------------	---	------------	-------

**ELECTRICAL CONSTRUCTION & MAINTENANCE 178
ELECTRIC MOTOR CONTROL II****3.00 UNITS****Evening Class**

4721	lec	6:00pm - 9:10pm	W	R. WINSTON	B 320
------	-----	-----------------	---	------------	-------

**ELECTRICAL CONSTRUCTION & MAINTENANCE 181
BASIC WIRING PRACTICES****3.00 UNITS****Evening Classes**

4733	lec	6:00pm - 9:10pm	T	R. RAMIREZ	B 301
4762	lec	6:00pm - 9:10pm	M	K.E. CURTIN	B 331

**ELECTRICAL CONSTRUCTION & MAINTENANCE 182
BASIC DIAGRAM AND CIRCUIT PRACTICES****1.00 UNIT****Evening Classes**

4734	lab	6:00pm - 9:10pm	Th	R. RAMIREZ	B 301
4736	lab	6:00pm - 9:05pm	W	K.E. CURTIN	B 301

**ELECTRICAL CONSTRUCTION & MAINTENANCE 183
RESIDENTIAL ELECTRIC WIRING****3.00 UNITS****Evening Classes**

4711	lec	6:00pm - 9:10pm	W	E.N. MAALOUF	B 352
4727	lec	6:00pm - 9:10pm	F	G.B. NASRALLAH	D 325

**ELECTRICAL CONSTRUCTION & MAINTENANCE 184
MOTOR CONTROL PRINCIPLES AND PRACTICES****3.00 UNITS****Evening Class**

4737	lec	6:00pm - 6:45pm	MW	F. BRKIC	B 304
&	lab	6:45pm - 9:10pm	MW	F. BRKIC	B 304

**ELECTRICAL CONSTRUCTION & MAINTENANCE 185
DIRECTED STUDY - ELECTRICAL CONSTRUCTION & MAINTENANCE****1.00 UNIT**

8006	lec	0:55 hrs/wk TBA	-	W.G. HANLEY	B 301
------	-----	-----------------	---	-------------	-------

**ELECTRICAL CONSTRUCTION & MAINTENANCE 186
INDUSTRIAL ELECTRICAL PRINCIPLES AND PRACTICES****3.00 UNITS****Evening Class**

4869	lec	6:00pm - 6:45pm	TTh	STAFF	B 304
&	lab	6:45pm - 9:10pm	TTh	STAFF	B 304

**ELECTRICAL CONSTRUCTION & MAINTENANCE 187
ADVANCED PROGRAMMABLE CONTROLLERS****4.00 UNITS****Evening Class**

4730	lec	6:00pm - 7:20pm	TTh	L.D. POGOLER	C 201
&	lab	7:20pm - 9:35pm	TTh	L.D. POGOLER	C 201

**ELECTRICAL CONSTRUCTION & MAINTENANCE 193
CONDUIT BENDING AND CALCULATIONS****3.00 UNITS****Evening Class**

4773	lec	6:00pm - 6:45pm	TTh	R.E. JACKSON	B 337
&	lab	6:45pm - 9:10pm	TTh	R.E. JACKSON	B 337

**ELECTRICAL CONSTRUCTION & MAINTENANCE 193A
CONDUIT BENDING LABORATORY****1.00 UNIT**

8158	lab	10:10am - 1:20pm	Th	R.E. JACKSON	B 337
8174	lab	10:10am - 1:20pm	Th	R.E. JACKSON	B 337

**ELECTRICAL CONSTRUCTION & MAINTENANCE 195
GROUNDING: FUNDAMENTALS, APPLICATIONS AND PRACTICES****3.00 UNITS****Evening Class**

4770	lec	8:00am - 11:10am	S	M.D. ROGERS	B 353
------	-----	------------------	---	-------------	-------

**ELECTRICAL CONSTRUCTION & MAINTENANCE 199
JOURNEYMAN ELECTRICIAN EXAM PREPARATION****3.00 UNITS****Evening Class**

4735	lec	6:00pm - 7:25pm	T	W.D. ELARTON	F 208
&	lab	7:25pm - 9:10pm	T	W.D. ELARTON	F 208
&	lab	6:00pm - 9:10pm	Th	W.D. ELARTON	F 208

ELECTRICAL CONSTRUCTION & MAINTENANCE 205 2.00 UNITS
SOLAR ENERGY INSTALLATION & MAINTENANCE PRINCIPLES AND PRACTICES

8335	lab	2:30pm - 5:40pm	MW	B. GOLUZA	F 151
Evening class					
4863	lab	6:00pm - 7:05pm	MW	B. GOLUZA	F 151
&	lab	7:05pm - 9:10pm	MW	B. GOLUZA	F 151

ELECTRICAL LINEMAN

ELECTRICAL LINEMAN 601 15.00 UNITS
POWER LINE MECHANIC - TRAINEE (600 HOURS)

8320	lec	7:00am - 8:10am	MTWThF	K.L. BUSHMAN	POLE YARD
Team	lab	8:10am - 2:20pm	MTWThF	K.L. BUSHMAN	POLE YARD

ELECTRONICS

ELECTRONICS 002 3.00 UNITS
INTRODUCTION TO ELECTRONICS (CSU)

0461	lec	10:10am - 1:20pm	W	S.A. ROOSTA	E 306
------	-----	------------------	---	-------------	-------

ELECTRONICS TECHNOLOGY

ELECTRONICS TECHNOLOGY 150 3.00 UNITS
SOLDERING SURFACE MOUNT TECHNOLOGY (CSU)

0464	lec	7:00am - 9:05am	W	S. CYRUS	E 304
&	lab	9:25am - 12:35pm	W	S. CYRUS	E 304

ELECTRONICS TECHNOLOGY 151 3.00 UNITS
DC THEORY AND CIRCUIT FUNDAMENTALS (CSU)

0467	lec	7:00am - 8:25am	T	S.A. ROOSTA	E 306
&	lec	8:30am - 10:00am	Th	S.A. ROOSTA	E 306

ELECTRONICS TECHNOLOGY 152 2.00 UNITS
DC THEORY AND CIRCUIT FUNDAMENTALS LAB (UC:CSU)

0470	lab	8:30am - 11:50am	T	S.A. ROOSTA	E 305
&	lab	10:10am - 1:30pm	Th	S.A. ROOSTA	E 305

ELECTRONICS TECHNOLOGY 153 1.00 UNIT
APPLIED DC CALCULATIONS (UC:CSU)

0473	lec	7:00am - 8:25am	Th	S.A. ROOSTA	E 306
------	-----	-----------------	----	-------------	-------

ELECTRONICS TECHNOLOGY 157 3.00 UNITS
SEMICONDUCTORS DEVICES AND APPLICATIONS (UC:CSU)

0485	lec	7:00am - 8:25am	TTh	S. CYRUS	E 301
------	-----	-----------------	-----	----------	-------

ELECTRONICS TECHNOLOGY 158 3.00 UNITS
SEMICONDUCTORS DEVICES AND ELECTRONICS LABORATORY (UC:CSU)

0488	lab	7:00am - 1:00pm	M	R.W. CAMPBELL	E 304
&	lab	7:00am - 1:00pm	Th	R.W. CAMPBELL	E 104

ELECTRONICS TECHNOLOGY 159 3.00 UNITS
DIGITAL CIRCUITS AND APPLICATIONS (UC:CSU)

0491	lec	8:35am - 10:00am	TTh	S. CYRUS	E 301
------	-----	------------------	-----	----------	-------

ELECTRONICS TECHNOLOGY 160 2.00 UNITS
DIGITAL CIRCUITS AND APPLICATIONS LAB (UC:CSU)

0494	lab	10:10am - 1:20pm	TTh	S. CYRUS	E 301
------	-----	------------------	-----	----------	-------

ELECTRONICS TECHNOLOGY 161 3.00 UNITS
F.C.C. RADIO OPERATOR LICENSE (UC:CSU)

7832	lec	3:10 hrs/wk TBA	-	E.L. CHAVEZ	ON LINE
• Please visit the online program homepage at lattc.edu/lattc/on_line/classes.htm prior to the start of class for directions, or see pages 82-84 of this schedule for more information.					

ELECTRONICS TECHNOLOGY 162 3.00 UNITS
INTRODUCTION TO ELECTRONICS COMMUNICATIONS (UC:CSU)

0500	lec	7:00am - 8:25am	TTh	M. QUAN	E 105
------	-----	-----------------	-----	---------	-------

ELECTRONICS TECHNOLOGY 163 3.00 UNITS
INTRODUCTION TO ELECTRONICS COMMUNICATIONS LAB (UC:CSU)

0503	lab	7:00am - 1:00pm	M	E.L. CHAVEZ	E 106
&	lab	8:35am - 1:00pm	Th	E.L. CHAVEZ	E 106

ELECTRONICS TECHNOLOGY 252 3.00 UNITS
NETWORK CABLING SPECIALIST

0509	lec	7:00am - 9:05am	M	S. CYRUS	E 304
&	lab	9:25am - 12:35pm	M	S. CYRUS	E 304

ELECTRONICS TECHNOLOGY 253 3.00 UNITS
FIBER OPTICS

0512	lec	7:00am - 9:05am	F	R.D. LANDEEN	E 304
&	lab	9:25am - 12:35pm	F	R.D. LANDEEN	E 304

ELECTRONICS TECHNOLOGY 254 3.00 UNITS
COMPUTER APPLICATIONS FOR ELECTRONICS TECHNOLOGY

0515	lec	7:00am - 9:05am	M	S.A. ROOSTA	E 200
&	lab	9:25am - 12:25pm	M	S.A. ROOSTA	E 200

ELECTRONICS TECHNOLOGY 255 1.00 UNIT
COMPUTER-BASED ELECTRONICS I

0518	lab	7:00am - 10:10am	W	S.A. ROOSTA	E 200
------	-----	------------------	---	-------------	-------

ELECTRONICS TECHNOLOGY 941 4.00 UNITS
COOPERATIVE EDUCATION - ELECTRONICS TECHNOLOGY

See page 85 for detail and meeting times					
9080	lec	4:25 hrs/wk TBA	-	C.A. MORLEY MOWER	D 236

ENGINEER-OPERATION/ MAINTENANCE

ENGINEER-OPERATION/MAINTENANCE 228 STEAM PLANT OPERATION I

6.00 UNITS

Evening Class

4755 lec 6:00pm - 9:10pm MW V. MARTINOV F 208

ENGINEER-OPERATION/MAINTENANCE 229 STEAM PLANT OPERATION II

6.00 UNITS

Evening Class

4756 lec 6:00pm - 9:10pm TTh P.A. BRADY B 320

ENGINEERING, GENERAL

ENGINEERING, GENERAL 101 INTRODUCTION TO SCIENCE, ENGINEERING AND TECHNOLOGY (UC:CSU)

2.00 UNITS

1690 lec 7:00am - 8:05am M M.A. EL TAWANSY K 420
& lec 7:00am - 8:05am W M.A. EL TAWANSY K 420

ENGINEERING, GENERAL 131 STATICS (UC:CSU)

3.00 UNITS

Prerequisite: Math 265 with a grade of 'C' or better.

1691 lec 7:00am - 8:25am T M.A. EL TAWANSY K 422
& lec 7:00am - 8:25am Th M.A. EL TAWANSY K 420
& lec 2:25 hrs/wk TBA - M.A. EL TAWANSY K 422

ENGINEERING, GENERAL 151 MATERIALS OF ENGINEERING (UC:CSU)

3.00 UNITS

Prerequisite: Math 265, Chemistry 101 & Physics 001 with a grade of 'C' or better.

1692 lec 10:10am - 11:35am MW F.J. PADILLA K 422

ENGLISH

ENGLISH 021 ENGLISH FUNDAMENTALS (NDA)

3.00 UNITS

Prerequisite: English 64.

1140 lec 8:35am - 10:00am MW R.M. SHARMA F 209
1361 lec 11:45am - 1:10pm TTh G.P. MCCANTS F 211
1362 lec 1:30pm - 2:55pm MW L.A. STAHL TE 215
1363 lec 10:10am - 11:35am TTh F.E. LENNON F 209
1380 lec 7:00am - 8:25am MW D.S. SMITH TE 213
1384 lec 8:35am - 10:00am MW H.M. DOSS F 210
1385 lec 9:00am - 12:10pm S G.B. BLAKE TE 206
1387 lec 8:00am - 11:10am F L.E. MALDAGUE TE 2081388 lec 10:10am - 11:35am MW R.N. SHAKIR TE 213
1389 lec 10:10am - 11:35am MW R.M. SHARMA F 231
1393 lec 8:00am - 12:15pm F T.M. DOLAN TE 210

(13 Week Class - Starts 9/20/2010, Ends 12/19/2010)

1410 lec 8:35am - 10:00am TTh R.M. SHARMA TE 206
1411 lec 10:10am - 11:35am TTh G.P. MCCANTS F 211
1414 lec 8:35am - 10:00am TTh T.M. DOLAN TE 210
1515 lec 11:45am - 1:10pm MW R.N. SHAKIR TE 210
1565 lec 11:45am - 1:10pm MW R.M. SHARMA TE 206

Evening Classes

3831 lec 6:00pm - 9:10pm T A.A. STEVENS TE 215
3932 lec 6:00pm - 9:10pm M A.A. STEVENS TE 215
3933 lec 6:00pm - 9:10pm Th F.J. VILLANI TE 215
3934 lec 6:00pm - 9:10pm W F.J. VILLANI TE 215

ENGLISH 028 INTERMEDIATE READING AND COMPOSITION

3.00 UNITS

Prerequisite: English 21.

1171 lec 8:35am - 10:00am MW M.A. GONZALEZ TE 215
1202 lec 10:10am - 11:35am TTh R.A. MANCIA TE 208
1346 lec 10:10am - 11:35am MW A. DURAN F 234
1369 lec 10:10am - 11:45am TTh J.M. GANGEL VASQUEZ TE 212
1392 lec 1:10pm - 2:35pm TTh J.M. GANGEL VASQUEZ TE 212
1394 lec 11:45am - 1:10pm TTh S.V. MITCHELL F 223
1395 lec 8:35am - 10:00am TTh R.A. MANCIA TE 208
1397 lec 1:30pm - 2:55pm MW L.M. MORENO TE 212
1398 lec 12:30pm - 3:40pm S B.L. JACOBS TE 210
1399 lec 10:10am - 11:35am MW R.A. MANCIA TE 208
1400 lec 8:35am - 10:00am TTh E.A. GREGORY F 210
1418 lec 11:45am - 1:10pm MW A.E. MENDEZ F 209

Evening Classes

3833 lec 6:00pm - 9:10pm Th L.I. FOSTER TE 210
3902 lec 6:00pm - 9:10pm M M.A. KOBLER TE 208
3903 lec 6:00pm - 9:10pm T L.I. FOSTER TE 210
3904 lec 6:00pm - 9:10pm W M.A. KOBLER TE 208

ENGLISH 046 READING AND STUDY IMPROVEMENT (NDA)

3.00 UNITS

1419 lec 7:00am - 8:25am TTh D.S. SMITH TE 201

ENGLISH 064 INTERMEDIATE READING AND COMPOSITION: BASIC SKILLS (NDA)

3.00 UNITS

1381 lec 10:10am - 11:35am MW T.M. DOLAN TE 210
1382 lec 11:45am - 1:10pm MW R.A. MANCIA TE 208
1396 lec 10:10am - 11:35am TTh R.M. SHARMA F 222
1450 lec 8:35am - 10:00am MW J.M. GANGEL-VASQUEZ TE 210
1451 lec 1:30pm - 2:55pm TTh T.M. DOLAN TE 210
1452 lec 11:45am - 1:10pm TTh T.M. DOLAN TE 208

Evening Classes

3911 lec 6:00pm - 9:10pm M E.F. MENZIES F 224
3912 lec 6:00pm - 9:10pm T E.F. MENZIES F 224
3913 lec 6:00pm - 9:10pm W J.C. DANIELS TE 210

ENGLISH 094 INTENSIVE GRAMMAR REVIEW (NDA)

3.00 UNITS

1457 lec 1:30pm - 4:40pm T S.V. MITCHELL F 223

ENGLISH 101**COLLEGE READING AND COMPOSITION I (UC:CSU)**

Prerequisite: English 28.

1204	lec	11:45am - 1:10pm	MW	L.M. MORENO	TE 212
&	lec	1:05 hrs/wk TBA	-	L.M. MORENO	TE 212
1486	lec	10:10am - 11:35am	TTh	R.N. SHAKIR	F 224
1487	lec	10:10am - 11:35am	MW	A.E. MENDEZ	F 209
1488	lec	11:45am - 1:10pm	TTh	M.A. GONZALEZ	TE 215
1489	lec	8:35am - 10:00am	TTh	R.N. SHAKIR	TE 212
1497	lec	8:35am - 10:00am	MW	R.A. MANCIA	TE 208
1576	lec	8:35am - 10:00am	MW	R.A. MANCIA	TE 208

- Section #1576 - Honor class

7950 lec 3:10 hrs/wk TBA - L.M. MORENO ON LINE

- Please visit the online program homepage at <http://moodle.lattc.edu> prior to the start of class for directions, or see pages 82-84 of this schedule for more information.

Evening Classes

3906	lec	8:35am - 11:45am	S	B.L. JACOBS	TE 210
3907	lec	6:00pm - 9:10pm	Th	W.L. RYDER	TE 206
3915	lec	6:00pm - 9:10pm	M	J.R. O KANE	TE 212
3916	lec	6:00pm - 9:10pm	T	W.L. RYDER	TE 206
4020	lec	6:00pm - 9:10pm	Th	W.L. RYDER	TE 206

- Section #4020 - Honor class.

4021 lec 6:00pm - 9:10pm T W.L. RYDER TE 206

- Section #4021 - Honor class

English 101 is also offered through Instructional Television (ITV) Program. For registration and orientation, see Ad on page 87

ENGLISH 102**COLLEGE READING AND COMPOSITION II (UC:CSU)**

Prerequisite: English 101.

1550	lec	10:10am - 11:35am	MW	J.M. GANGEL VASQUEZ	TE 212
1559	lec	10:10am - 11:35am	TTh	E.A. GREGORY	F 210
1581	lec	10:10am - 11:35am	TTh	E.A. GREGORY	F 210

- Section #1581 - Honor Class.

English 102 is also offered through Instructional Television (ITV) Program. For registration and orientation, see Ad on page 87

ENGLISH 103**COMPOSITION AND CRITICAL THINKING (UC:CSU)**

Prerequisite: English 101.

1510	lec	10:10am - 11:35am	MW	M.A. GONZALEZ	TE 215
1511	lec	11:45am - 1:10pm	MW	M.A. GONZALEZ	TE 215
1512	lec	11:45am - 1:10pm	TTh	L.M. MORENO	TE 210
1513	lec	8:35am - 10:00am	MW	L.M. MORENO	TE 212
1569	lec	10:10am - 11:40am	TTh	M.A. GONZALEZ	TE 215
1572	lec	11:45am - 1:10pm	TTh	L.M. MORENO	TE 210

- Section #1572 - Honor class.

Evening Classes

3909	lec	6:00pm - 9:10pm	W	A.A. AHMED	TE 212
3910	lec	6:00pm - 9:10pm	T	A.A. AHMED	TE 212

ENGLISH 203**WORLD LITERATURE I (UC:CSU)**

Prerequisite: English 28.

1558	lec	11:45am - 1:10pm	TTh	J.M. GANGEL VASQUEZ	TE 212
------	-----	------------------	-----	---------------------	--------

3.00 UNITS**ENGLISH 205****ENGLISH LITERATURE I (UC:CSU)**

Prerequisite: English 101.

7958	lec	3:10 hrs/wk TBA	-	L.M. MORENO	ON LINE
------	-----	-----------------	---	-------------	---------

- Please visit the online program homepage at <http://moodle.lattc.edu> prior to the start of class for directions, or see pages 82-84 of this schedule for more information.

ENGLISH 212**POETRY (UC:CSU)**

Prerequisite: English 28.

1557	lec	1:30pm - 4:40pm	M	J.C. DANIELS	TE 210
------	-----	-----------------	---	--------------	--------

ENGLISH 215**SHAKESPEARE I (UC:CSU)**

Prerequisite: English 28.

1556	lec	11:45am - 1:10pm	TTh	R.N. SHAKIR	F 223
------	-----	------------------	-----	-------------	-------

3.00 UNITS**3.00 UNITS**

ENGLISH AS A SECOND LANGUAGE

ENGLISH AS A SECOND LANGUAGE 002**12.00 UNITS****COLLEGE ENGLISH AS A SECOND LANGUAGE II: INTEGRATED SKILLS (NDA)**

Prerequisite: ESL 1.

0881	lec	8:35am - 11:35am	MTWTh	N. HARLEY	E 209
------	-----	------------------	-------	-----------	-------

ENGLISH AS A SECOND LANGUAGE 003A**6.00 UNITS****COLLEGE ENGLISH AS A ESL III: WRITING AND GRAMMAR**

Prerequisite: ESL 2.

0882	lec	10:10am - 11:35am	MTWTh	V.F. LE VEQUE	E 101
0883	lec	5:45pm - 8:45pm	MW	STAFF	E 211

ENGLISH AS A SECOND LANGUAGE 003B**3.00 UNITS****COLLEGE ENGLISH AS A SECOND LANGUAGE III: WRITING AND GRAMMAR**

Prerequisite: ESL 2.

0884	lec	8:35am - 10:00am	MW	V.F. LE VEQUE	E 101
0885	lec	5:45pm - 8:35pm	T	STAFF	E 105

ENGLISH AS A SECOND LANGUAGE 003C**3.00 UNITS****COLLEGE ENGLISH AS A SECOND LANGUAGE III: LISTENING AND SPEAKING**

Prerequisite: ESL 2.

0886	lec	8:35am - 10:00am	TTh	L. MALDAGUE	E 105
------	-----	------------------	-----	-------------	-------

ENGLISH AS A SECOND LANGUAGE 004A**6.00 UNITS****COLLEGE ENGLISH AS A SECOND LANGUAGE IV: READING AND VOCABULARY**

Prerequisite: ESL 3A

0887	lec	10:10am - 11:35am	MTWTh	K.C. KINYON	E 216
0888	lec	5:45pm - 8:35pm	MW	STAFF	E 105

English as a Second Language Course Sequence

Trade-Tech offers a complete English as a Second Language package, all the way from ESL 1, for complete beginners, to ESL 8, which leads into English 101.

English learners can improve their skills in writing and grammar (the ESL "A" classes), reading and vocabulary (the "B" classes), and listening and speaking (the "C" classes).

The units from core ESL classes above level 2 not only apply towards the community college degree, but also earn transfer credit.

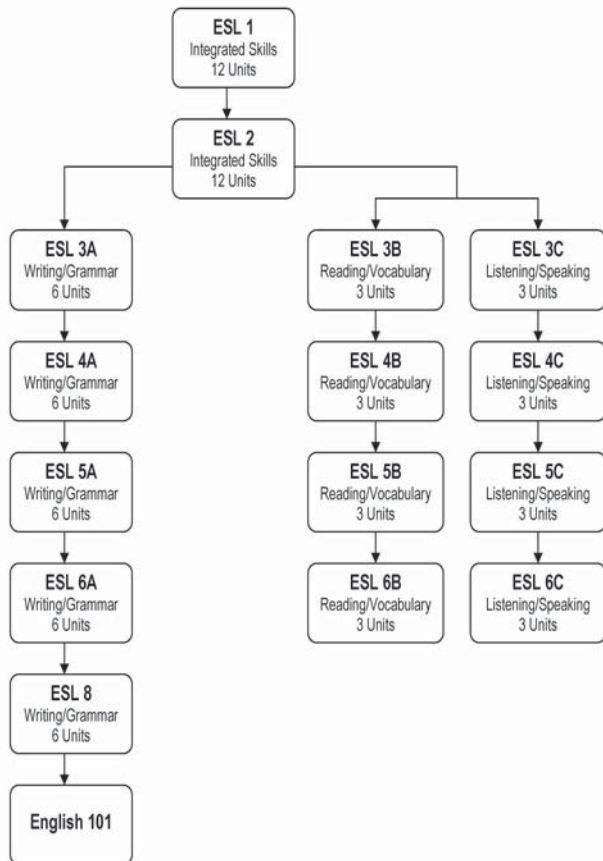

ENGLISH AS A SECOND LANGUAGE 004B 3.00 UNITS COLLEGE ENGLISH AS A SECOND LANGUAGE IV: WRITING AND GRAMMAR (UC:CSU)

Prerequisite: 3B

0889	lec	8:35am - 10:00am	TTh	K.C. KINYON	TBA
0890	lec	5:45pm - 8:35pm	Th	STAFF	E 209

ENGLISH AS A SECOND LANGUAGE 005A 6.00 UNITS COLLEGE ENGLISH AS A SECOND LANGUAGE V: WRITING AND GRAMMAR (CSU)

Prerequisite: ESL 4A

0891	lec	10:10am - 11:35am	MTWTh	C. ANKETELL	E 214
0892	lec	11:45am - 1:10pm	MTWTh	K.C. KINYON	TBA

ENGLISH AS A SECOND LANGUAGE 005B 3.00 UNITS COLLEGE ENGLISH AS A SECOND LANGUAGE V: READING AND VOCABULARY

Prerequisite: ESL 4B

0893	lec	8:35am - 10:00am	MW	K.C. KINYON	E 216
------	-----	------------------	----	-------------	-------

ENGLISH AS A SECOND LANGUAGE 006A 6.00 UNITS COLLEGE ENGLISH AS A SECOND LANGUAGE VI: WRITING AND GRAMMAR (CSU)

Prerequisite: ESL 5A

0894	lec	10:10am - 11:35am	MTWTh	STAFF	E 211
0895	lec	11:45am - 1:10pm	MTWTh	STAFF	E 214

ENGLISH AS A SECOND LANGUAGE 008 6.00 UNITS ADVANCED ESL COMPOSITION (UC:CSU)

Prerequisite: ESL 6A

0899	lec	11:45am - 1:10pm	MTWTh	N.N. DE LA PENA	E 211
------	-----	------------------	-------	-----------------	-------

ENVIRONMENTAL SCIENCE

ENVIRONMENTAL SCIENCE 001 3.00 UNITS THE HUMAN ENVIRONMENT: PHYSICAL PROCESSES (UC:CSU)

7828 lec 3:30 hrs/wk TBA - R.E. PIEPER ON LINE

- Please visit the online program homepage at <http://moodle.lattc.edu> prior to the start of class for directions, or see pages 82-84 of this schedule for more information.

FASHION DESIGN

FASHION DESIGN 111 4.00 UNITS CLOTHING CONSTRUCTION (CSU)

7050	lec	7:00am - 8:00am	MTWThF	T.R. JACKSON	D 332
&	lab	8:00am - 11:10am	MTWThF	T.R. JACKSON	D 332
<i>(8 Week Class - Starts 8/30/2010, Ends 10/22/2010)</i>					
7051	lec	7:00am - 8:00am	MTWThF	STAFF	D 234
&	lab	8:00am - 11:10am	MTWThF	STAFF	D 234
<i>(8 Week Class - Starts 8/30/2010, Ends 10/22/2010)</i>					
7052	lec	11:50am - 12:50pm	MTWThF	C.M. IAFFALDANO	D 234
&	lab	12:50pm - 4:00pm	MTWThF	C.M. IAFFALDANO	D 234
<i>(8 Week Class - Starts 8/30/2010, Ends 10/22/2010)</i>					
7053	lec	7:00am - 8:00am	MTWThF	A.D. LEE	D 234
&	lab	8:00am - 11:10am	MTWThF	A.D. LEE	D 234
<i>(8 Week Class - Starts 10/25/2010, Ends 12/17/2010)</i>					
7054	lec	11:50am - 12:50pm	MTWThF	STAFF	D 234
&	lab	12:50pm - 4:00pm	MTWThF	STAFF	D 234
<i>(8 Week Class - Starts 10/25/2010, Ends 12/17/2010)</i>					

FASHION DESIGN 112 4.00 UNITS BASIC FASHION ART AND DESIGN (CSU)

7055	lec	7:00am - 8:00am	MTWThF	C.R. WATANABE	D 230
&	lab	8:00am - 11:10am	MTWThF	C.R. WATANABE	D 230
<i>(8 Week Class - Starts 8/30/2010, Ends 10/22/2010)</i>					
7056	lec	11:50am - 12:50pm	MTWThF	STAFF	D 230
&	lab	12:50pm - 4:00pm	MTWThF	STAFF	D 230
<i>(8 Week Class - Starts 8/30/2010, Ends 10/22/2010)</i>					
7057	lec	7:00am - 8:00am	MTWThF	M.K. BRAND NJOKU	D 230
&	lab	8:00am - 11:10am	MTWThF	M.K. BRAND NJOKU	D 230
<i>(8 Week Class - Starts 10/25/2010, Ends 12/17/2010)</i>					

7058	lec	7:00am - 7:50am	MTWThF	C.R. WATANABE	D 105
&	lab	8:00am - 11:10am	MTWThF	C.R. WATANABE	D 105
<i>(8 Week Class - Starts 10/25/2010, Ends 12/17/2010)</i>					
7059	lec	11:50am - 12:50pm	MTWThF	M.B. COREAS	D 230
&	lab	12:50pm - 4:00pm	MTWThF	M.B. COREAS	D 230
<i>(8 Week Class - Starts 10/25/2010, Ends 12/17/2010)</i>					

FASHION DESIGN 119 HISTORY OF COSTUME **3.00 UNITS**

7062	lec	9:00am - 10:45am	MW	M.B. COREAS	D 236
------	-----	------------------	----	-------------	-------

FASHION DESIGN 120 BASIC PATTERN MAKING & DESIGN (CSU) **4.00 UNITS**

Prerequisite: Fashion Design 111 & 112

7064	lec	7:00am - 8:00am	MTWThF	T.R. JACKSON	D 332
&	lab	8:00am - 11:10am	MTWThF	T.R. JACKSON	D 332
<i>(8 Week Class - Starts 10/25/2010, Ends 12/17/2010)</i>					
7065	lec	7:00am - 8:00am	MTWThF	A.D. LEE	D 106
&	lab	8:00am - 11:10am	MTWThF	A.D. LEE	D 106
<i>(8 Week Class - Starts 10/25/2010, Ends 12/17/2010)</i>					
7066	lec	11:50am - 12:50pm	MTWThF	N. GLASS VILLALOBOS	D 205
&	lab	12:50pm - 4:00pm	MTWThF	N. GLASS VILLALOBOS	D 205
<i>(8 Week Class - Starts 10/25/2010, Ends 12/17/2010)</i>					

FASHION DESIGN 122 GRADING AND MARKER MAKING **4.00 UNITS**

7068	lec	7:00am - 8:00am	MTWThF	C.E. SAPOS	D 205
&	lab	8:00am - 11:10am	MTWThF	C.E. SAPOS	D 205
<i>(8 Week Class - Starts 8/30/2010, Ends 10/22/2010)</i>					
7069	lec	7:00am - 8:00am	MTWThF	STAFF	D 105
&	lab	8:00am - 11:10am	MTWThF	STAFF	D 105
<i>(8 Week Class - Starts 8/30/2010, Ends 10/22/2010)</i>					
7070	lec	11:50am - 12:50pm	MTWThF	N. GLASS VILLALOBOS	D 205
&	lab	12:50pm - 4:00pm	MTWThF	N. GLASS VILLALOBOS	D 205
<i>(8 Week Class - Starts 8/30/2010, Ends 10/22/2010)</i>					

FASHION DESIGN 125 TEXTILES, FIBERS AND FABRICS, PROPERTIES AND MANUFACTURING (CSU) **3.00 UNITS**

7072	lec	12:00pm - 1:45pm	TTh	M.K. BRAND NJOKU	D 236
------	-----	------------------	-----	------------------	-------

FASHION DESIGN 126 MANUFACTURING AND DESIGN ROOM PROCESS (CSU) **1.00 UNIT**

7074	lec	9:00am - 11:20am	Th	C.L. ANDERSON	D 236
<i>(8 Week Class - Starts 8/30/2010, Ends 10/22/2010)</i>					

FASHION DESIGN 130 DRAPING & DESIGN (CSU) **4.00 UNITS**

Prerequisite: Fashion Design 111, 112, 120 & 122

7076	lec	7:00am - 8:00am	MTWThF	C.E. SAPOS	D 205
&	lab	8:00am - 11:10am	MTWThF	C.E. SAPOS	D 205
<i>(8 Week Class - Starts 10/25/2010, Ends 12/17/2010)</i>					
7077	lec	7:00am - 8:00am	MTWThF	H. KIM	D 102
&	lab	8:00am - 11:10am	MTWThF	H. KIM	D 102
<i>(8 Week Class - Starts 10/25/2010, Ends 12/17/2010)</i>					
7078	lec	11:50am - 12:50pm	MTWThF	C.M. IAFFALDANO	D 130
&	lab	12:50pm - 4:00pm	MTWThF	C.M. IAFFALDANO	D 130
<i>(8 Week Class - Starts 10/25/2010, Ends 12/17/2010)</i>					

FASHION DESIGN 132 ADVANCED PATTERNS AND DESIGN (CSU) **4.00 UNITS**

Prerequisite: Fashion Design 111, 112, 120 & 122

7079	lec	7:00am - 8:00am	MTWThF	H. KIM	D 102
&	lab	8:00am - 11:10am	MTWThF	H. KIM	D 102
<i>(8 Week Class - Starts 8/30/2010, Ends 10/22/2010)</i>					
7080	lec	7:00am - 8:00am	MTWThF	A.D. LEE	D 333
&	lab	8:00am - 11:10am	MTWThF	A.D. LEE	D 333
<i>(8 Week Class - Starts 8/30/2010, Ends 10/22/2010)</i>					
7081	lec	11:50am - 12:50pm	MTWThF	M.B. COREAS	D 230
&	lab	12:50pm - 4:00pm	MTWThF	M.B. COREAS	D 230
<i>(8 Week Class - Starts 8/30/2010, Ends 10/22/2010)</i>					

FASHION DESIGN 137 BUSTIER CREATION **2.00 UNITS**

Prerequisites: FASHDSN 111, 112, 120.

7112	lab	8:35am - 3:05pm	S	L.A. MELIN	D 102
------	-----	-----------------	---	------------	-------

FASHION DESIGN 138 TAILORING TECHNIQUES FOR READY TO WEAR **2.00 UNITS**

Prerequisites: FASHDSN 111 or 222.

7093	lab	12:00pm - 1:00pm	MW	A.D. LEE	D 332
&	lab	1:00pm - 4:30pm	MW	A.D. LEE	D 332
<i>(8 Week Class - Starts 10/25/2010, Ends 12/17/2010)</i>					

FASHION DESIGN 141 ADVANCED DESIGN (CSU) **4.00 UNITS**

Prerequisites: FASHDSN 111, 112, 120, 122, 130, 132.

7085	lec	7:00am - 8:00am	MTWThF	F. DREBSKAYA	D 130
&	lab	8:00am - 11:10am	MTWThF	F. DREBSKAYA	D 130
<i>(8 Week Class - Starts 8/30/2010, Ends 10/22/2010)</i>					
7086	lec	7:00am - 8:00am	MTWThF	D.M. THORNTON	D 106
&	lab	8:00am - 11:10am	MTWThF	D.M. THORNTON	D 106
<i>(8 Week Class - Starts 8/30/2010, Ends 10/22/2010)</i>					

FASHION DESIGN 142 MANUFACTURING PRODUCTION (CSU) **4.00 UNITS**

Prerequisites: FASHDSN 111, 112, 120, 122, 130, 132, 141.

7089	lec	7:00am - 8:00am	MTWThF	F. DREBSKAYA	D 130
&	lab	8:00am - 11:10am	MTWThF	F. DREBSKAYA	D 130
<i>(8 Week Class - Starts 10/25/2010, Ends 12/17/2010)</i>					
7090	lec	7:00am - 8:00am	MTWThF	D.M. THORNTON	D 106
&	lab	8:00am - 11:10am	MTWThF	D.M. THORNTON	D 106
<i>(8 Week Class - Starts 10/25/2010, Ends 12/17/2010)</i>					

FASHION DESIGN 147 DEVELOPING A FASHION SHOW **2.00 UNITS**

7116	lec	12:00pm - 1:30pm	F	C.L. ANDERSON	D 236
&	lec	1:00 hrs/wk	TBA	-	C.L. ANDERSON
<i>(8 Week Class - Starts 10/25/2010, Ends 12/17/2010)</i>					

FASHION DESIGN 151 ADVANCED FASHION ART AND DESIGN **2.00 UNITS**

Prerequisites: FASHDSN 112 or 236.

7095	lec	12:00pm - 1:00pm	MW	C.R. WATANABE	D 333
&	lab	1:00pm - 3:25pm	MW	C.R. WATANABE	D 333
<i>(8 Week Class - Starts 10/25/2010, Ends 12/17/2010)</i>					

FASHION DESIGN 222 SAMPLE MAKING AND DESIGN I **2.00 UNITS**

7101	lab	8:35am - 3:05pm	S	F. DREBSKAYA	D 130
Evening Class					
4250	lab	6:00pm - 9:10pm	TTh	B.S. TORDA	D 234

FASHION DESIGN 223 SAMPLE MAKING AND DESIGN II	2.00 UNITS				
7103 lab 8:35am - 3:05pm S	F. DREBSKAYA	D 130			
Evening Class					
4251 lab 6:00pm - 9:10pm TTh	B.S. TORDA	D 234			
FASHION DESIGN 224 SAMPLE MAKING AND DESIGN III	2.00 UNITS				
7105 lab 8:35am - 3:05pm S	F. DREBSKAYA	D 130			
Evening Class					
4252 lab 6:00pm - 9:10pm TTh	B.S. TORDA	D 234			
FASHION DESIGN 225 PATTERN MAKING AND DESIGN I	2.00 UNITS				
7108 lab 8:35am - 3:05pm S	M. BROOKS	D 205			
Evening Class					
4253 lab 6:00pm - 9:10pm MW	D.J. FORAL	D 130			
FASHION DESIGN 226 PATTERN MAKING AND DESIGN II	2.00 UNITS				
Evening Class					
4254 lab 6:00pm - 9:10pm MW	L.A. MELIN	D 332			
FASHION DESIGN 227 PATTERN MAKING AND DESIGN III	2.00 UNITS				
Evening Class					
4255 lab 6:00pm - 9:10pm MW	L.A. MELIN	D 332			
FASHION DESIGN 228 PATTERN GRADING AND DESIGN I	2.00 UNITS				
Evening Class					
4256 lab 6:00pm - 9:10pm TTh	N. GLASS VILLALOBOS	D 106			
FASHION DESIGN 230 CONTEMPORARY GARMENT CONSTRUCTION TECHNIQUES	1.00 UNIT				
7091 lab 1:00pm - 3:00pm MW	F. DREBSKAYA	D 106			
<i>(15 Week Class - Starts 9/6/2010, Ends 12/17/2010)</i>					
Evening Class					
4282 lab 4:00pm - 6:10pm TTh	STAFF	D 230			
<i>(14 Week Class - Starts 9/16/2010, Ends 12/19/2010)</i>					
FASHION DESIGN 231 CONTEMPORARY PATTERN MAKING TECHNIQUES	1.00 UNIT				
7098 lab 1:00pm - 3:00pm MW	F. DREBSKAYA	D 106			
<i>(15 Week Class - Starts 9/6/2010, Ends 12/17/2010)</i>					
Evening Class					
4283 lab 4:00pm - 6:00pm TTh	STAFF	D 230			
<i>(14 Week Class - Starts 9/16/2010, Ends 12/19/2010)</i>					
FASHION DESIGN 236 FASHION SKETCHING AND DESIGN I	2.00 UNITS				
Evening Class					
4260 lab 6:00pm - 9:10pm MW	C.R. WATANABE	D 230			
FASHION DESIGN 237 FASHION SKETCHING AND DESIGN II	2.00 UNITS				
Evening Class					
4262 lab 6:00pm - 9:10pm MW	C.R. WATANABE	D 230			
FASHION DESIGN 238 FASHION SKETCHING AND DESIGN III	2.00 UNITS				
Evening Class					
4264 lab 6:00pm - 9:10pm MW	C.R. WATANABE	D 230			
FASHION DESIGN 239 GOWN DRAPING AND DESIGN I	2.00 UNITS				
7120 lab 8:35am - 3:05pm S	D.J. CUNNIGAN	D 333			
Evening Class					
4267 lab 6:00pm - 9:10pm TTh	H. KIM	D 105			
FASHION DESIGN 240 GOWN DRAPING AND DESIGN II	2.00 UNITS				
7121 lab 8:35am - 3:05pm S	D.J. CUNNIGAN	D 333			
Evening Class					
4269 lab 6:00pm - 9:10pm TTh	H. KIM	D 102			
FASHION DESIGN 241 GOWN DRAPING AND DESIGN III	2.00 UNITS				
7122 lab 8:35am - 3:05pm S	D.J. CUNNIGAN	D 333			
Evening Class					
4271 lab 6:00pm - 9:10pm TTh	H. KIM	D 102			
FASHION DESIGN 244 COMPUTER FASHION ART	2.00 UNITS				
Evening Class					
4273 lab 6:00pm - 9:10pm TTh	L.L. ADAMS	D 203			
FASHION DESIGN 250 BEGINNING COMPUTER APPAREL SYSTEMS	2.00 UNITS				
Evening Class					
4274 lab 6:00pm - 9:10pm MW	D.A. JOHNSON	D 133			
FASHION DESIGN 255 COMPUTERIZED PRODUCT DESIGN	2.00 UNITS				
Evening Class					
4276 lab 6:00pm - 9:10pm TTh	D.A. JOHNSON	D 133			
FASHION DESIGN 257 APPAREL PATTERN DESIGN SYSTEMS	2.00 UNITS				
Evening Class					
4279 lab 6:00pm - 9:10pm MW	C.E. SAPOS	D 132			
FASHION DESIGN 258 COMPUTER-AIDED PATTERN SYSTEMS	2.00 UNITS				
Prerequisites: FASHDSN 120 or 225.					
7128 lab 8:35am - 3:05pm S	C. ALCALA	D 132			
FASHION DESIGN 259 CAD APPAREL DESIGN (GERBER ARTWORKS)	2.00 UNITS				
7129 lab 8:35am - 3:05pm S	C.E. SAPOS	D 133			
FASHION DESIGN 264 APPAREL COMPUTER SYSTEMS ANALYSIS (CSU)	2.00 UNITS				
7140 lec 8:00am - 9:00am TTh	C. ALCALA	D 132			
& lab 9:00am - 11:40am TTh	C. ALCALA	D 132			
<i>(8 Week Class - Starts 10/25/2010, Ends 12/17/2010)</i>					
FASHION DESIGN 270 ILLUSTRATOR FOR FASHION DESIGN	2.00 UNITS				
7134 lab 8:35am - 3:05pm S	L.L. ADAMS	D 203			
FASHION DESIGN 941 COOPERATIVE EDUCATION - FASHION DESIGN	4.00 UNITS				
See page 85 for detail and meeting times					
9092 lec 4:25 hrs/wk TBA	N. GLASS VILLALOBOS	D 236			

FASHION MERCHANDISING

FASHION MERCHANDISING 001 ENTREPRENEURIAL FASHION (CSU) 3.00 UNITS

7160	lec	12:30pm - 1:30pm	W	D.R. MURPHY	D 133
&	lec	12:30pm - 1:45pm	F	D.R. MURPHY	D 200

FASHION MERCHANDISING 010 RETAIL MERCHANDISING (CSU) 3.00 UNITS

7161	lec	8:30am - 10:15am	MW	D.R. MURPHY	D 200
------	-----	------------------	----	-------------	-------

FASHION MERCHANDISING 025 FASHION AND INDUSTRY INTERCHANGE (CSU) 3.00 UNITS

7162	lec	10:30am - 12:15pm	MW	D.R. MURPHY	D 200
------	-----	-------------------	----	-------------	-------

FASHION MERCHANDISING 030 WHOLESALE MERCHANDISING (CSU) 3.00 UNITS

7163	lec	12:00pm - 1:45pm	TTh	D.R. MURPHY	D 200
------	-----	------------------	-----	-------------	-------

FASHION MERCHANDISING 041 FASHION MERCHANDISE BUYING (CSU) 3.00 UNITS

7173	lec	9:00am - 10:15am	TTh	D.R. MURPHY	D 200
&	lec	10:15am - 11:15am	TTh	D.R. MURPHY	D 200

FASHION MERCHANDISING 941 COOPERATIVE EDUCATION - FASHION MERCHANDISING 4.00 UNITS

See page 85 for detail and meeting times

9088	lec	4:25 hrs/wk TBA	-	N. GLASS VILLALOBOS	D 236
------	-----	-----------------	---	---------------------	-------

FRENCH

FRENCH 001 ELEMENTARY FRENCH I (UC:CSU) 5.00 UNITS

1420	lec	11:45am - 12:55pm	MTWTh	R. PALACIOS OCHOA	K 364
------	-----	-------------------	-------	-------------------	-------

FRENCH 002 ELEMENTARY FRENCH II (UC:CSU) 5.00 UNITS

1422	lec	1:30pm - 2:40pm	MTWTh	N.E. TAMER	K 366
------	-----	-----------------	-------	------------	-------

FRENCH 003 INTERMEDIATE FRENCH I (UC:CSU) 5.00 UNITS

6828	lec	1:30pm - 4:00pm	MTh	R. PALACIOS OCHOA	K 364
------	-----	-----------------	-----	-------------------	-------

GEOGRAPHY

GEOGRAPHY 001 PHYSICAL GEOGRAPHY (UC:CSU) 3.00 UNITS

1719	lec	10:10am - 11:35am	TTh	STAFF	H 351
------	-----	-------------------	-----	-------	-------

Evening Class

4080	lec	6:00pm - 9:10pm	M	D.M. LANDAU	H 352
------	-----	-----------------	---	-------------	-------

GEOGRAPHY 002 CULTURAL ELEMENTS OF GEOGRAPHY (UC:CSU) 3.00 UNITS

7850	lec	3:10 hrs/wk TBA	-	G.J. SCHWARTZ	ON LINE
------	-----	-----------------	---	---------------	---------

- Please visit the online program homepage at <http://moodle.lattc.edu> prior to the start of class for directions, or see pages 82-84 of this schedule for more information.

GEOLOGY

GEOLOGY 001 PHYSICAL GEOLOGY (UC:CSU) 3.00 UNITS

1711	lec	8:30am - 11:40am	S	J.T. HALL	H 354
------	-----	------------------	---	-----------	-------

GEOLOGY 006 PHYSICAL GEOLOGY LABORATORY (CSU) 2.00 UNITS

1715	lec	12:10pm - 1:10pm	S	J.T. HALL	H 353
&	lab	1:10pm - 3:20pm	S	J.T. HALL	H 353

GRAPHIC DESIGN

SEE CLASSES UNDER VISUAL COMMUNICATIONS – PAGES 76.

HEALTH

HEALTH 006 NUTRITION FOR HEALTHFUL LIVING AND FITNESS ACTIVITIES (UC:CSU) 3.00 UNITS

Evening Class

3806	lec	4:30pm - 6:35pm	W	S.L. SULLIVAN	F 215
&	lab	6:35pm - 7:35pm	W	S.L. SULLIVAN	F 215
&	lab	1:05 hrs/wk TBA	-	S.L. SULLIVAN	ON LINE

- Please visit the online program homepage at <http://moodle.lattc.edu> prior to the start of class for directions, or see pages 82-84 of this schedule for more information.

HEALTH 008 WOMEN'S PERSONAL HEALTH (UC:CSU) 3.00 UNITS

1328	lec	1:20pm - 2:45pm	MW	S.L. SULLIVAN	F 215
1337	lec	3:00pm - 4:25pm	MW	S.L. SULLIVAN	F 215
7900	lec	3:15 hrs/wk TBA	-	L.D. DELZEIT	ON LINE

- Please visit the online program homepage at <http://moodle.lattc.edu> prior to the start of class for directions, or see pages 82-84 of this schedule for more information.

HEALTH 011 PRINCIPLES OF HEALTHFUL LIVING (UC:CSU) 3.00 UNITS

1324	lec	7:00am - 8:25am	MW	M.A. WAGENBACH	F 215
1325	lec	8:35am - 10:00am	MW	S.L. SULLIVAN	F 215
1326	lec	10:10am - 11:35am	MW	S.L. SULLIVAN	F 215
1327	lec	11:45am - 1:10pm	MW	S.L. SULLIVAN	F 215
1329	lec	7:00am - 8:25am	TTh	M.A. WAGENBACH	F 215

1330	lec	8:35am - 10:00am	TTh	R.L. WELLS	F 216
1331	lec	10:10am - 11:35am	TTh	R.L. WELLS	F 216
1332	lec	11:45am - 1:10pm	TTh	R.L. WELLS	F 215
1336	lec	10:10am - 11:35am	MTWTh	G.R. KING	TBA

(8 Week Class - Starts 10/25/2010, Ends 12/16/2010)

7901	lec	3:10 hrs/wk TBA	-	G.D. JOHNSON	ON LINE
------	-----	-----------------	---	--------------	---------

- Please visit the online program homepage at <http://moodle.lattc.edu> prior to the start of class for directions, or see pages 82-84 of this schedule for more information.

Evening Classes

3802	lec	6:00pm - 9:10pm	M	D.R. LAGOS	F 215
3803	lec	6:00pm - 9:10pm	W	D.R. LAGOS	F 216

Health 11 is also offered through Instructional Television (ITV) Program. For registration and orientation, see Ad on page 87

HEALTH 012 3.00 UNITS SAFETY EDUCATION AND FIRST AID (UC:CSU)

1333	lec	8:35am - 10:00am	TTh	D. DE FRANCO BROWNE	F 215
1335	lec	9:00am - 12:10pm	S	L.R. RIVERA	F 215

HEALTH 021 3.00 UNITS HUMAN SEXUALITY (UC:CSU)

1334	lec	8:35am - 10:00am	MW	M.A. WAGENBACH	F 216
------	-----	------------------	----	----------------	-------

HEALTH OCCUPATIONS

HEALTH OCCUPATIONS 037 5.00 UNITS NURSE ASSISTANT

7786	lec	7:00am - 1:30pm	M	B. SOLES	TB 100
	& lab	7:00am - 1:30pm	TW	STAFF	COUN VILL

(8 Week Class - Starts 9/27/2010, Ends 11/19/2010)

- Country Villa East, 2415 South Western Avenue, Los Angeles, CA 90018.

7796	lec	7:00am - 12:30pm	M	B. SOLES	TB 100
	& lab	7:00am - 1:30pm	ThF	B. SOLES	COUN VILL

(8 Week Class - Starts 9/27/2010, Ends 11/19/2010)

- Country Villa East, 2415 South Western Avenue, Los Angeles, CA 90018.

HEALTH OCCUPATIONS 038 2.00 UNITS HOME HEALTH AIDE

7608	lec	7:00am - 1:30pm	M	B. SOLES	TB 100
	& lab	7:00am - 3:30pm	ThF	B. SOLES	COUN VILL

(2 Week Class - Starts 11/29/2010, Ends 12/10/2010)

- Country Villa East, 2415 South Western Avenue, Los Angeles, CA 90018.

7787	lec	7:00am - 1:30pm	M	B. SOLES	TB 100
	& lab	7:00am - 3:30pm	TW	STAFF	COUN VILL

(2 Week Class - Starts 11/29/2010, Ends 12/10/2010)

- Country Villa East, 2415 South Western Avenue, Los Angeles, CA 90018.

HEALTH OCCUPATIONS 039 2.00 UNITS MATHEMATICS OF DRUGS AND SOLUTIONS

7791	lec	1:00pm - 3:20pm	M	R.C. VILLORA	TB 100
------	-----	-----------------	---	--------------	--------

HEALTH OCCUPATIONS 040 3.00 UNITS INTRODUCTION TO MEDICAL ASSISTING

7790	lec	9:00am - 12:20pm	F	M.D. KENDRICK	TB 100
------	-----	------------------	---	---------------	--------

HEALTH OCCUPATIONS 043 4.00 UNITS PATHOPHYSIOLOGY FOR THE MEDICAL ASSISTANT

7792	lec	8:00am - 12:15pm	Th	L.V. JACOBS	TB 100
------	-----	------------------	----	-------------	--------

HISTORY

HISTORY 011 3.00 UNITS POLITICAL AND SOCIAL HISTORY OF THE UNITED STATES I (UC:CSU)

1010	lec	8:35am - 10:00am	MW	D.B. JACKSON	TE 313
1011	lec	8:35am - 10:00am	MW	T.E. ROBINSON	TE 301
1012	lec	10:10am - 11:35am	MW	T.E. ROBINSON	TE 301
1013	lec	11:45am - 1:10pm	MW	T.E. ROBINSON	TE 301
1014	lec	8:35am - 10:00am	TTh	T.E. ROBINSON	TE 301
1015	lec	10:10am - 11:35am	TTh	D.B. JACKSON	TE 313
1016	lec	11:45am - 1:00pm	TTh	D.B. JACKSON	TE 313
1167	lec	8:35am - 10:00am	MW	D.B. JACKSON	TE 313

- Section #1167 - Honor Class

7978	lec	3:10 hrs/wk TBA	-	A.I. RODRIGUEZ ESTRADA	ON LINE
------	-----	-----------------	---	------------------------	---------

- Please visit the online program homepage at <http://moodle.lattc.edu> prior to the start of class for directions, or see pages 82-84 of this schedule for more information.

Evening Classes

3611	lec	6:00pm - 9:10pm	T	G. KINCSES	TE 313
3612	lec	6:00pm - 9:10pm	Th	E.O. GUTIERREZ	TE 301

History 11 is also offered through Instructional Television (ITV) Program. For registration and orientation, see Ad on page 87

HISTORY 012 3.00 UNITS POLITICAL AND SOCIAL HISTORY OF THE UNITED STATES II (UC:CSU)

1017	lec	11:45am - 1:10pm	MW	D.B. JACKSON	TE 313
1018	lec	8:35am - 10:00am	TTh	D.B. JACKSON	TE 313
1019	lec	11:45am - 1:10pm	TTh	T.E. ROBINSON	TE 301
1166	lec	8:35am - 10:00am	TTh	D.B. JACKSON	TE 313

- Section #1166 - Honor Class

7852	lec	4:15 hrs/wk TBA	-	A.I. RODRIGUEZ ESTRADA	ON LINE
------	-----	-----------------	---	------------------------	---------

(12 Week Class - Starts 9/27/2010, Ends 12/19/2010)

- Please visit the online program homepage at <http://moodle.lattc.edu> prior to the start of class for directions, or see pages 82-84 of this schedule for more information.

Evening Class

3613	lec	6:00pm - 9:10pm	W	B.D. FRIEDMAN	TE 313
------	-----	-----------------	---	---------------	--------

HISTORY 041 3.00 UNITS THE AFRICAN AMERICAN IN THE HISTORY OF THE U.S. I (UC:CSU)

1022	lec	10:10am - 11:35am	TTh	T.E. ROBINSON	TE 301
------	-----	-------------------	-----	---------------	--------

HISTORY 086 3.00 UNITS INTRODUCTION TO WORLD CIVILIZATION I (UC:CSU)

1027	lec	10:10am - 11:35am	MW	D.B. JACKSON	TE 313
------	-----	-------------------	----	--------------	--------

HISTORY 087 3.00 UNITS INTRODUCTION TO WORLD CIVILIZATION II (UC:CSU)

1028	lec	10:10am - 11:35am	TTh	R.D. FISHMAN	TE 210
------	-----	-------------------	-----	--------------	--------

HUMANITIES

HUMANITIES 001 3.00 UNITS CULTURAL PATTERNS OF WESTERN CIVILIZATION (UC:CSU)

1402	lec	11:45am - 1:10pm	MW	R. DOYLE	F 222
1403	lec	2:40pm - 5:50pm	T	C.D. PARKER	F 229
1404	lec	8:35am - 10:00am	TTh	A.E. ARMSTRONG	F 223
1405	lec	9:00am - 12:10pm	S	C.D. PARKER	F 229
1406	lec	11:45am - 1:10pm	TTh	R.K. TROPF	F 214
1430	lec	10:10am - 11:35am	MW	C.D. PARKER	F 229
7941	lec	3:30 hrs/wk TBA	-	M.A. GONZALEZ	ON LINE

- Please visit the online program homepage at <http://moodle.lattc.edu> prior to the start of class for directions, or see pages 82-84 of this schedule for more information.

Evening Class

3895	lec	6:00pm - 9:10pm	T	C.D. PARKER	F 229
------	-----	-----------------	---	-------------	-------

HUMANITIES 002 3.00 UNITS STUDIES IN SELECTED CULTURES (UC:CSU)

1407	lec	10:10am - 11:35am	TTh	A.E. ARMSTRONG	F 223
------	-----	-------------------	-----	----------------	-------

JOURNALISM

JOURNALISM 101 3.00 UNITS COLLECTING AND WRITING NEWS (CSU)

1432	lec	8:35am - 10:00am	MW	R.M. SANTANA	F 228
------	-----	------------------	----	--------------	-------

JOURNALISM 105 3.00 UNITS MASS COMMUNICATIONS (UC:CSU)

1433	lec	10:10am - 11:35am	MW	R.M. SANTANA	F 228
------	-----	-------------------	----	--------------	-------

LABOR STUDIES

LABOR STUDIES 002 3.00 UNITS COLLECTIVE BARGAINING (CSU)

Evening Class

3251	lec	6:00pm - 9:10pm	T	J. WALKER	TEAM 396
------	-----	-----------------	---	-----------	----------

- Teamsters Local 396 880 Oak Pk Rd, Covina, CA 91724. Contact: Labor Center (213) 763-7129

LABOR STUDIES 004 3.00 UNITS LABOR IN AMERICA (CSU)

0430	lec	10:10am - 11:35am	TTh	L. SIEGEL	TE 120
------	-----	-------------------	-----	-----------	--------

Evening Class

3252	lec	6:00pm - 9:10pm	T	M.A. HART	UFCW 324
------	-----	-----------------	---	-----------	----------

- UFCW Local 324, 8530 Stanton Ave., Buena Park, CA 90622. Contact: Labor Center (213) 763-7129

LABOR STUDIES 005 3.00 UNITS GRIEVANCE AND ARBITRATION PROCEDURES (CSU)

7860	lec	3:10 hrs/wk TBA	-	J.F. WALKER	ON LINE
------	-----	-----------------	---	-------------	---------

- Please visit the online program homepage at <http://moodle.lattc.edu> prior to the start of class for directions, or see pages 82-84 of this schedule for more information.

LABOR STUDIES 006 3.00 UNITS LABOR AND COMMUNITY SERVICES (CSU)

Evening Class

3255	lec	6:00pm - 9:10pm	Th	STAFF	CWA 9586
------	-----	-----------------	----	-------	----------

- CWA Local 9586, 12330 E. Firestone Blvd., Norwalk, CA 90650

LABOR STUDIES 013 3.00 UNITS UNION LEADERSHIP (CSU)

Evening Class

3250	lec	6:00pm - 9:10pm	M	C.A. HICKS	UFCW 1428
------	-----	-----------------	---	------------	-----------

- UFCW Local 1428, 705 W. Arrow Hwy., Claremont, CA 91711. Contact: Labor Center (213) 763-7129

LABOR STUDIES 020 3.00 UNITS LABOR LAW (CSU)

7861	lec	3:10 hrs/wk TBA	-	W.J. DELLORO	ON LINE
------	-----	-----------------	---	--------------	---------

- Please visit the online program homepage at <http://moodle.lattc.edu> prior to the start of class for directions, or see pages 82-84 of this schedule for more information.

LABOR STUDIES 021 3.00 UNITS THE WORKING CLASS AND CINEMA (UC:CSU)

6807	lec	1:00pm - 4:00pm	T	J.V. CALDERON	ALC CONT
------	-----	-----------------	---	---------------	----------

- ALC-Miguel Contreras Learning Center, 322 S. Lucas Ave., Los Angeles, CA 90017. Contact: Labor Center at (213) 763-7129

6808	lec	4:00pm - 7:00pm	M	STAFF	CIVI ROYB
------	-----	-----------------	---	-------	-----------

- Civitas - Edward R. Roybal Learning Center, 1200 W. Colton St., Los Angeles, CA 90026. Contact: Labor Center at (213) 763-7129

Evening Class

3253	lec	6:00pm - 9:10pm	W	J.M. WHITE	NALC 24
------	-----	-----------------	---	------------	---------

- NALC Branch 24, 774 Valencia St., Los Angeles, CA 90017. Contact: Labor Center (213) 763-7129

LABOR STUDIES 101 1.00 UNIT INTRODUCTION TO UNIONS

0439	lec	9:00am - 3:05pm	S	W.J. DELLORO	LA CFL
------	-----	-----------------	---	--------------	--------

(9 Week Class - Starts 9/11/2010, Ends 11/6/2010)

- Los Angeles County Federation of Labor, 2130 West. James M. Wood Blvd., Los Angeles, CA 90006. Contact: Labor Center. (213) 763-7129

0449	lec	8:30am - 5:20pm	F	W.J. DELLORO	AL CONT
------	-----	-----------------	---	--------------	---------

(2 Week Class - Starts 11/5/2010, Ends 11/12/2010)

- ALC-Miguel Contreras Learning Center, 322 S. Lucas Ave., Los Angeles, CA 90017. Contact: Labor Center. (213) 763-7129

0450	lec	8:30am - 5:20pm	F	W.J. DELLORO	LA CFL
------	-----	-----------------	---	--------------	--------

(2 Week Class - Starts 12/3/2010, Ends 12/10/2010)

- Los Angeles County Federation of Labor, 2130 West. James M. Wood Blvd., Los Angeles, CA 90006. Contact: Labor Center. (213) 763-7129

LABOR STUDIES 102 1.00 UNIT CONTRACT NEGOTIATIONS SKILLS (CSU)

0445	lec	8:30am - 5:20pm	S	J.V. CALDERON	T-L 100
------	-----	-----------------	---	---------------	---------

(2 Week Class - Starts 12/4/2010, Ends 12/11/2010)

LABOR STUDIES 105 1.00 UNIT GRIEVANCE HANDLING SKILLS (CSU)

0437	lec	8:30am - 5:20pm	FS	T. CONROW	TEAM 848
------	-----	-----------------	----	-----------	----------

(1 Week Class - Starts 9/17/2010, Ends 9/22/2010)

0438	lec	8:30am - 5:20pm	SU	M.A. MEJIA	CSEA EL
------	-----	-----------------	----	------------	---------

(1 Week Class - Starts 11/13/2010, Ends 11/14/2010)

- CSEA El Monte, 4600 Santa Anita Ave., El Monte, CA 91731; Contact: Labor Center (213) 763-7129

0440	lec	8:30am - 5:20pm	SU	L.M. ZIGMAN	T-L 100
------	-----	-----------------	----	-------------	---------

(1 Week Class - Starts 9/11/2010, Ends 9/12/2010)

LABOR STUDIES 106 **1.00 UNIT**
COMMUNITY SERVICES SEMINAR (CSU)

 0443 lec 8:30am - 5:20pm S A. OLIVAS T-L 100
 (2 Week Class - Starts 10/23/2010, Ends 10/30/2010)

LABOR STUDIES 109 **1.00 UNIT**
UNION BUILDING STRATEGIES (CSU)

 0446 lec 5:30pm - 9:35pm M T. CONROW ILWU 63
 (4 Week Class - Starts 9/9/2010, Ends 9/30/2010)
 • ILWU 63-350 West 5th Street, San Pedro, CA 90731. Contact: Labor Center (213) 763-7129

LABOR STUDIES 113 **1.00 UNIT**
UNION LEADERSHIP SEMINAR (CSU)

 0447 lec 8:30am - 5:20pm FSU D. MAYER CSEA GLEN
 • CSEA Glendale, 1505 Gardena Ave., Glendale, CA 91204; Labor Center (213) 763-7029
 0435 lec 8:30am - 5:20pm S G. MAFFEI RANC ELEM
 (2 Week Class - Starts 10/23/2010, Ends 10/30/2010)
 • Ranchito Avenue Elementary School, 7940 Ranchito Avenue, Panorama City, CA 91402. Contact: Labor Center at (213) 763-7129
 0436 lec 8:30am - 5:20pm S G. MAFFEI HOOV ELEM
 (2 Week Class - Starts 11/6/2010, Ends 11/13/2010)
 • Hoover Street Elementary, 2726 Francis Ave., Los Angeles, CA 90005; Contact: Labor Center (213) 763-7129

LABOR STUDIES 123 **1.00 UNIT**
STEWART TRAINING (CSU)

 0441 lec 8:00am - 5:20pm S W.J. DELORO TE 221
 (2 Week Class - Starts 9/18/2010, Ends 9/25/2010)

LABOR STUDIES 127 **1.00 UNIT**
WORKER'S COMPENSATION (CSU)

 0442 lec 8:30am - 5:20pm SU S.T. FORD T-L 100
 (1 Week Class - Starts 10/2/2010, Ends 10/3/2010)

LABOR STUDIES 132 **1.00 UNIT**
STRATEGIC BARGAINING (CSU)

 0448 lec 8:30am - 5:20pm FS J.F. WALKER UFCW 1428
 (1 Week Class - Starts 10/22/2010, Ends 10/23/2010)
 • UFCW Local 1428, 705 W. Arrow Hwy., Claremont, CA 91711. Contact: Labor Center (213) 763-7129

LABOR STUDIES 134 **1.00 UNIT**
CALIFORNIA MINIMUM LABOR STANDARDS (CSU)

 0444 lec 8:30am - 5:20pm S R.A. CANTORE T-L 100
 (1 Week Class - Starts 11/6/2010, Ends 11/7/2010)

LABOR STUDIES 185 **1.00 UNIT**
DIRECTED STUDY - LABOR STUDIES (CSU)
Evening Class
 3271 lec 1:05 hrs/wk TBA - J.R. MCDOWELL LA CFL
 • Los Angeles County Federation of Labor, 2130 West. James M. Wood Blvd., Los Angeles, CA 90006.
 Contact: Labor Center. (213) 763-7129

LABOR STUDIES 285 **2.00 UNITS**
DIRECTED STUDY - LABOR STUDIES (CSU)
Evening Class
 3272 lec 2:05 hrs/wk TBA - J.R. MCDOWELL LA CFL
 • Los Angeles County Federation of Labor, 2130 West. James M. Wood Blvd., Los Angeles, CA 90006.
 Contact: Labor Center. (213) 763-7129

LABOR STUDIES 385 **3.00 UNITS**
DIRECTED STUDY - LABOR STUDIES (CSU)
Evening Class
 3273 lec 3:10 hrs/wk TBA - J.R. MCDOWELL LA CFL
 • Los Angeles County Federation of Labor, 2130 West. James M. Wood Blvd., Los Angeles, CA 90006.
 Contact: Labor Center. (213) 763-7129

LAW

LAW 018 **3.00 UNITS**
MARRIAGE AND FAMILY LAW (CSU)

0189 lec 11:45am - 1:10pm TTh K.L. GARY K 324

LEARNING SKILLS

Please note: Learning Skills course and section information is subject to change. please see flyers located in Admissions and Counseling Departments.

LEARNING SKILLS 001A **1.00 UNIT**
READING (NDA)

 0350 lab 3:10 hrs/wk TBA - A.K. RANDALL C 102
 0351 lab 3:10 hrs/wk TBA - A.K. RANDALL C 102
 1281 lab 3:10 hrs/wk TBA - M.C. ARMSTRONG C 102

LEARNING SKILLS 001B **1.00 UNIT**
READING (NDA)

 0353 lab 3:10 hrs/wk TBA - A.K. RANDALL C 102
 0354 lab 3:10 hrs/wk TBA - C.P. ANKETELL C 102
 1282 lab 3:10 hrs/wk TBA - M.C. ARMSTRONG C 102

LEARNING SKILLS 001C **1.00 UNIT**
READING (NDA)

1283 lab 3:10 hrs/wk TBA - M.C. ARMSTRONG C 102

LEARNING SKILLS 002A **1.00 UNIT**
ENGLISH FUNDAMENTALS (NDA)

 0357 lab 3:10 hrs/wk TBA - C.P. ANKETELL C 212
 0358 lab 3:10 hrs/wk TBA - C.P. ANKETELL C 102
 1284 lab 3:10 hrs/wk TBA - M.C. ARMSTRONG C 102

LEARNING SKILLS 002B **1.00 UNIT**
ENGLISH FUNDAMENTALS (NDA)

 0352 lab 3:10 hrs/wk TBA - A.K. RANDALL C 102
 0359 lab 3:10 hrs/wk TBA - C.P. ANKETELL C 102
 0360 lab 3:10 hrs/wk TBA - C.P. ANKETELL C 102
 1285 lab 3:10 hrs/wk TBA - M.C. ARMSTRONG C 102

LEARNING SKILLS 002C **1.00 UNIT**
ENGLISH FUNDAMENTALS (NDA)

1286 lab 3:10 hrs/wk TBA - C.P. ANKETELL C 102

**LEARNING SKILLS 004
THE MECHANICS OF SPELLING (NDA) 1.00 UNIT**

1287 lab 3:10 hrs/wk TBA - C.P. ANKETELL C 102

**LEARNING SKILLS 005
ENGLISH AS A SECOND LANGUAGE FUNDAMENTALS (NDA) 1.00 UNIT**

1288 lab 3:10 hrs/wk TBA - M.C. ARMSTRONG C 102

**LEARNING SKILLS 010A
MATHEMATICS FUNDAMENTALS (NDA) 1.00 UNIT**

0362 lec 8:30am - 9:15am M A.K. RANDALL C 200

0363 lec 10:10am - 11:15am T A.K. RANDALL C 200

0364 lec 11:45am - 12:50pm W A.K. RANDALL C 200

1289 lec 11:45am - 12:50pm Th A.K. RANDALL C 200

**LEARNING SKILLS 010B
MATHEMATICS FUNDAMENTALS (NDA) 1.00 UNIT**

0355 lab 2:05 hrs/wk TBA - A.K. RANDALL C 102

0365 lab 2:05 hrs/wk TBA - M.C. ARMSTRONG C 102

0366 lab 2:05 hrs/wk TBA - M.C. ARMSTRONG C 102

0367 lab 2:05 hrs/wk TBA - M.C. ARMSTRONG C 102

1290 lab 2:05 hrs/wk TBA - C.P. ANKETELL C 102

**LEARNING SKILLS 010C
MATHEMATICS FUNDAMENTALS (NDA) 1.00 UNIT**

0356 lab 2:05 hrs/wk TBA - C.P. ANKETELL C 102

1291 lab 2:05 hrs/wk TBA - M.C. ARMSTRONG C 102

**LEARNING SKILLS 062
GED PREPARATION: LITERATURE AND THE ARTS (NDA) 1.00 UNIT**

1292 lab 3:10 hrs/wk TBA - M.C. ARMSTRONG C 102

**LEARNING SKILLS 063
GED PREPARATION: WRITING SKILLS (NDA) 1.00 UNIT**

1296 lab 3:10 hrs/wk TBA - STAFF C 102

**LEARNING SKILLS 185
DIRECTED STUDY - LEARNING SKILLS (NDA) 1.00 UNIT**

0361 lec 1:05 hrs/wk TBA - A.K. RANDALL C 102

0413 lec 1:05 hrs/wk TBA - A.K. RANDALL C 102

0417 lec 1:05 hrs/wk TBA - A.K. RANDALL C 102

MACHINE SHOP

**MACHINE SHOP 111
PRINCIPLES OF MACHINE TOOLS I (CSU) 2.00 UNITS**

0600 lec 7:00am - 8:25am Th P.A. RAUTERKUS F 166E

& lec 7:00am - 8:25am T P.A. RAUTERKUS F 166

**MACHINE SHOP 112A
TECHNOLOGY AND APPLICATION OF MACHINING IA 3.00 UNITS**

0601 lab 7:00am - 10:10am MWF P.A. RAUTERKUS F 166

**MACHINE SHOP 112B
TECHNOLOGY AND APPLICATION OF MACHINING (CAD) IB 1.00 UNIT**

0603 lab 10:10am - 11:35am TTh P.A. RAUTERKUS F 166

**MACHINE SHOP 114
PRINT INTERPRETATION & SKETCHING (BLUEPRINT I) (CSU) 3.00 UNITS**

0602 lec 8:35am - 10:00am TTh P.A. RAUTERKUS F 166E

**MACHINE SHOP 115
BASIC APPLIED MATHEMATICAL CALCULATIONS (CSU) 3.00 UNITS**

0604 lec 10:10am - 11:35am MW P.A. RAUTERKUS F 166E

**MACHINE SHOP 131A
PRINCIPLES OF MACHINE TOOLS IIIA 2.00 UNITS**

0610 lec 7:00am - 8:25am Th S.T. SHIBUYA F 166C

& lec 7:00am - 8:25am T S.T. SHIBUYA F 164

**MACHINE SHOP 131B
PRINCIPLES OF MACHINE TOOLS (CNC) IIIB 3.00 UNITS**

0611 lec 10:10am - 11:35am TTh S.T. SHIBUYA F 164C

**MACHINE SHOP 132A
TECHNOLOGY AND APPLICATION OF MACHINING IIIA 3.00 UNITS**

0612 lab 7:00am - 10:10am MWF S.T. SHIBUYA F 164

**MACHINE SHOP 132B
TECHNOLOGY AND APPLICATION OF MACHINING (CAM) IIIB 1.00 UNIT**

0613 lab 8:35am - 10:00am TTh S.T. SHIBUYA F 151A

**MACHINE SHOP 135
ADVANCED APPLIED MATHEMATICAL CALCULATIONS (CSU) 3.00 UNITS**

0614 lec 10:10am - 11:35am MW S.T. SHIBUYA F 164C

MARKETING

**MARKETING 001
PRINCIPLES OF SELLING (CSU) 3.00 UNITS**

7957 lec 3:25 hrs/wk TBA - M.C. BESSLER ON LINE

- Please visit the online program homepage at <http://moodle.lattc.edu> prior to the start of class for directions, or see pages 82-84 of this schedule for more information.

**MARKETING 021
PRINCIPLES OF MARKETING (CSU) 3.00 UNITS**

7964 lec 3:25 hrs/wk TBA - M.C. BESSLER ON LINE

- Please visit the online program homepage at <http://moodle.lattc.edu> prior to the start of class for directions, or see pages 82-84 of this schedule for more information.

**Don't Wait,
Get Online!!!**

- Registration
- FAQ's
- Counseling
- Financial Aid
- Grades
- Orientation

www.lattc.edu

MATHEMATICS

MATHEMATICS 101 THE WORLD OF NUMBERS (NDA) 3.00 UNITS

1901	lec	8:35am - 10:00am	MW	N. SIMPSON-RODGERS	TE 306
1902	lec	10:10am - 11:35am	TTh	C. LOOP	TE 410
1903	lec	11:45am - 1:10pm	TTh	C. LOOP	TE 410

Evening Classes

4145	lec	6:00pm - 9:10pm	M	M.M. NAKANO	TE 412
4146	lec	6:00pm - 9:10pm	T	O.L. BARROW	TE 308

MATHEMATICS 105 ARITHMETIC (NDA) 3.00 UNITS

Prerequisite: MATH 101.

1906	lec	1:10pm - 2:35pm	TTh	M.A. EL TAWANSY	TE 310
------	-----	-----------------	-----	-----------------	--------

- The above class will be required to spend one TBA hour each week in the Math Lab, TE 423.

1909	lec	8:35am - 10:00am	MW	H. LIU	TE 412
------	-----	------------------	----	--------	--------

- The above class will be required to spend one TBA hour each week in the Math Lab, TE 423.

1910	lec	8:35am - 10:00am	TTh	R.S. SHERER	TE 408
------	-----	------------------	-----	-------------	--------

- The above class will be required to spend one TBA hour each week in the Math Lab, TE 423.

1911	lec	11:45am - 1:10pm	TTh	R.S. SHERER	TE 408
------	-----	------------------	-----	-------------	--------

- The above class will be required to spend one TBA hour each week in the Math Lab, TE 423.

1912	lec	10:10am - 11:35am	MW	N. SIMPSON-RODGERS	TE 306
------	-----	-------------------	----	--------------------	--------

- The above class will be required to spend one TBA hour each week in the Math Lab, TE 423.

1913	lec	10:10am - 11:35am	TTh	H. LIU	H 354
------	-----	-------------------	-----	--------	-------

- The above class will be required to spend one TBA hour each week in the Math Lab, TE 423.

1915	lec	11:45am - 1:10pm	MW	N. SIMPSON-RODGERS	TE 306
------	-----	------------------	----	--------------------	--------

- The above class will be required to spend one TBA hour each week in the Math Lab, TE 423.

1916	lec	10:10am - 11:35am	TTh	M. TOWHIDLOWT	E 415
------	-----	-------------------	-----	---------------	-------

- The above class will be required to spend one TBA hour each week in the Math Lab, TE 423.

7916	lec	3:10 hrs/wk TBA	-	T.S. MEFTAGH	ON LINE
------	-----	-----------------	---	--------------	---------

- The above class will be required to spend one TBA hour each week in the Math Lab, TE 423.

- Please visit the online program homepage at <http://moodle.lattc.edu> prior to the start of class for directions, or see pages 82-84 of this schedule for more information.

Evening Classes

4151	lec	6:00pm - 9:10pm	T	R.S. SHERER	TE 408
------	-----	-----------------	---	-------------	--------

- The above class will be required to spend one TBA hour each week in the Math Lab, TE 423.

4152	lec	6:00pm - 9:10pm	M	O.L. BARROW	TE 308
------	-----	-----------------	---	-------------	--------

- The above class will be required to spend one TBA hour each week in the Math Lab, TE 423.

4154	lec	6:00pm - 9:10pm	W	G.N. DAGHER	TE 410
------	-----	-----------------	---	-------------	--------

- The above class will be required to spend one TBA hour each week in the Math Lab, TE 423.

MATHEMATICS 112 PRE-ALGEBRA (NDA) 3.00 UNITS

Prerequisite: MATH 105.

1921	lec	7:00am - 8:25am	TTh	M. TOWHIDLOW	TE 308
------	-----	-----------------	-----	--------------	--------

1922	lec	8:35am - 10:00am	MW	C.K. CHEN	TE 408
------	-----	------------------	----	-----------	--------

1924	lec	10:10am - 11:35am	MW	H. LIU	TE 412
------	-----	-------------------	----	--------	--------

1926	lec	10:10am - 11:35am	TTh	M.A. EL TAWANSY	TE 306
------	-----	-------------------	-----	-----------------	--------

1927	lec	11:45am - 1:10pm	MW	M.A. EL TAWANSY	TE 306
------	-----	------------------	----	-----------------	--------

1928	lec	11:45am - 1:10pm	TTh	M.A. CHAMMAS	TE 415
------	-----	------------------	-----	--------------	--------

1929	lec	8:35am - 10:00am	TTh	H. LIU	TE 412
------	-----	------------------	-----	--------	--------

7917	lec	3:10 hrs/wk TBA	-	T.S. MEFTAGH	ON LINE
------	-----	-----------------	---	--------------	---------

- Please visit the online program homepage at <http://moodle.lattc.edu> prior to the start of class for directions, or see pages 82-84 of this schedule for more information.

Evening Classes

4161	lec	6:00pm - 9:10pm	Th	R. KUMADA	TE 408
------	-----	-----------------	----	-----------	--------

4162	lec	6:00pm - 9:10pm	M	G.N. DAGHER	TE 410
------	-----	-----------------	---	-------------	--------

4163	lec	6:00pm - 9:10pm	T	M. BURGIN	TE 415
------	-----	-----------------	---	-----------	--------

MATHEMATICS 113 ELEMENTARY ALGEBRA A 3.00 UNITS

Prerequisite: MATH 112.

1932	lec	10:10am - 11:35am	MW	K.H. LEE	TE 221
------	-----	-------------------	----	----------	--------

1933	lec	11:45am - 1:10pm	TTh	S. KUNARAK	TE 413
------	-----	------------------	-----	------------	--------

Evening Class

4170	lec	6:00pm - 9:10pm	T	B.A. PAIGE	TE 308
------	-----	-----------------	---	------------	--------

MATHEMATICS 114 ELEMENTARY ALGEBRA B 3.00 UNITS

Prerequisite: Math 113.

1936	lec	10:10am - 11:35am	MW	STAFF	TE 415
------	-----	-------------------	----	-------	--------

1937	lec	10:10am - 11:35am	TTh	B.A. PAIGE	TE 310
------	-----	-------------------	-----	------------	--------

Evening Class

4176	lec	6:00pm - 9:10pm	T	M.M. NAKANO	TE 412
------	-----	-----------------	---	-------------	--------

Course Sequence in Mathematics

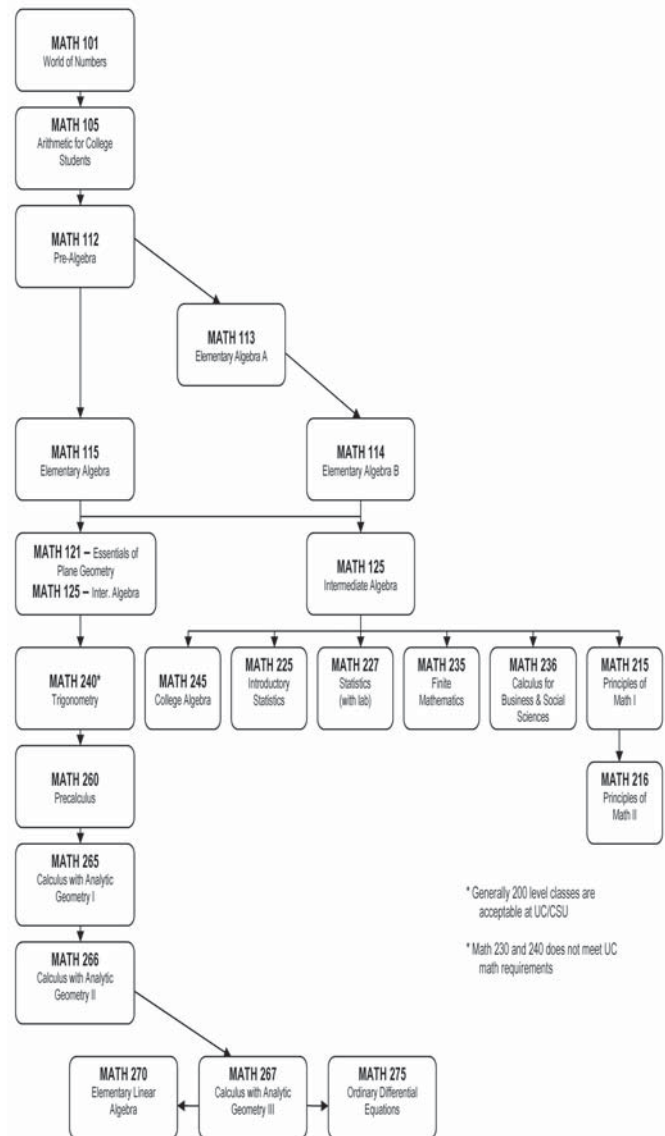

Note: Math Competency Exam given each semester. Meets elementary Algebra graduation requirements. Contact the Math Department at (213) 763-7330.

17499

**MATHEMATICS 115
ELEMENTARY ALGEBRA**

Prerequisite: MATH 112.

Section	Days	Time	Days	Instructor	Units
1940	lec	7:00am - 8:10am	MTWTh	A.A. BAKMAN	TE 410
1941	lec	7:00am - 8:10am	MTWTh	K.H. LEE	TE 221
1942	lec	8:35am - 9:45am	MTWTh	M.M. MURPHY	TE 310
1943	lec	8:35am - 9:45am	MTWTh	S. KUNARAK	TE 413
1945	lec	10:10am - 11:20am	MTWTh	S. KUNARAK	TE 413
1946	lec	11:45am - 12:55pm	MTWTh	H. LIU	TE 412
1947	lec	11:45am - 12:55pm	MTWTh	T.S. MEFTAGH	TE 413
1948	lec	8:00am - 1:20pm	S	L.V. TRAN	TE 310
1949	lec	2:00pm - 4:35pm	MW	S. KUNARAK	TE 413
1950	lec	2:00pm - 4:35pm	TTh	N. SIMPSON-RODGERS	TE 306
7920	lec	5:25 hrs/wk TBA	-	T.S. MEFTAGH	ON LINE

- Please visit the online program homepage at <http://moodle.lattc.edu> prior to the start of class for directions, or see pages 82-84 of this schedule for more information.

Evening Classes

4180	lec	6:00pm - 8:35pm	MW	P.A. PETER	TE 408
4181	lec	6:00pm - 8:35pm	TTh	M.N. NISHIMOTO	TE 413

**MATHEMATICS 121
ESSENTIALS OF PLANE GEOMETRY**

Prerequisite: MATH 115 or MATH 113/114.

1957	lec	8:35am - 10:00am	TTh	A. OVANESSIAN	TE 306
------	-----	------------------	-----	---------------	--------

**MATHEMATICS 125
INTERMEDIATE ALGEBRA**

Prerequisite: MATH 115 or MATH 113/114

Section	Days	Time	Days	Instructor	Units
1960	lec	7:00am - 8:10am	MTWTh	L.F. AVILA	TE 415
1961	lec	8:35am - 9:45am	MTWTh	L.F. AVILA	TE 415
1962	lec	10:10am - 11:20am	MTWTh	E.M. LIGHT	TE 308
1963	lec	11:45am - 12:55pm	MTWTh	K.H. LEE	TE 221
1964	lec	8:35am - 9:45am	MTWTh	A.A. BAKMAN	TE 410
7921	lab	5:25 hrs/wk TBA	-	T.S. MEFTAGH	ON LINE

- Please visit the online program homepage at <http://moodle.lattc.edu> prior to the start of class for directions, or see pages 82-84 of this schedule for more information.

Evening Classes

4190	lec	6:00pm - 8:35pm	MW	B.T. BAYSSA	TE 310
4191	lec	6:00pm - 8:35pm	TTh	N. SIMPSON-RODGERS	TE 306

Math 125 is also offered through Instructional Television (ITV) Program. For registration and orientation, see Ad on page 87

**MATHEMATICS 225
INTRODUCTORY STATISTICS (UC:CSU)**

Prerequisite: MATH 125.

Evening Classes

4210	lec	6:00pm - 9:10pm	T	P.A. PETER	TE 410
4211	lec	6:00pm - 9:10pm	Th	P.A. KARASIK	TE 410

**MATHEMATICS 227
STATISTICS (UC:CSU)**

Prerequisite: MATH 125.

1978	lec	10:10am - 12:20pm	MW	A.A. BAKMAN	TE 423
1979	lec	10:10am - 12:20pm	TTh	L.F. AVILA	TE 423
7922	lec	4:15 hrs/wk TBA	-	A.A. BAKMAN	ON LINE

- Please visit the online program homepage at <http://moodle.lattc.edu> prior to the start of class for directions, or see pages 82-84 of this schedule for more information.

**MATHEMATICS 235
FINITE MATHEMATICS (UC:CSU)**

Prerequisite: MATH 125.

1980	lec	11:45am - 12:55pm	MTWTh	M.M. MURPHY	TE 310
------	-----	-------------------	-------	-------------	--------

**MATHEMATICS 240
TRIGONOMETRY (CSU)**

Prerequisites: MATH 121 and 125.

1982	lec	7:00am - 8:25am	MW	M.M. MURPHY	TE 310
------	-----	-----------------	----	-------------	--------

**MATHEMATICS 245
COLLEGE ALGEBRA (UC:CSU)**

Prerequisite: MATH 125.

1985	lec	10:10am - 11:35am	TTh	K.H. LEE	TE 221
------	-----	-------------------	-----	----------	--------

Evening Class

4216	lec	6:00pm - 9:10pm	Th	V. ZINENBERG	TE 310
------	-----	-----------------	----	--------------	--------

**MATHEMATICS 260
PRE-CALCULUS (UC:CSU)**

Prerequisite: MATH 240.

1990	lec	11:45am - 12:55pm	MTWTh	E.M. LIGHT	TE 308
------	-----	-------------------	-------	------------	--------

**MATHEMATICS 265
CALCULUS WITH ANALYTIC GEOMETRY I (UC:CSU)**

Prerequisite: MATH 260.

1992	lec	8:35am - 9:45am	MTWTh	K.H. LEE	TE 221
------	-----	-----------------	-------	----------	--------

**MATHEMATICS 266
CALCULUS WITH ANALYTIC GEOMETRY II (UC:CSU)**

Prerequisite: MATH 265.

1993	lec	8:35am - 9:45am	MTWTh	E.M. LIGHT	TE 308
------	-----	-----------------	-------	------------	--------

**MATHEMATICS 267
CALCULUS WITH ANALYTIC GEOMETRY III (UC:CSU)**

Prerequisite: MATH 266.

1994	lec	7:00am - 8:10am	MTWTh	H. LIU	TE 412
------	-----	-----------------	-------	--------	--------

**MATHEMATICS 270
ELEMENTARY LINEAR ALGEBRA (UC:CSU)**

Prerequisite: MATH 267.

1995	lec	10:10am - 11:35am	MW	L. AVILA	TE 415
------	-----	-------------------	----	----------	--------

MICROBIOLOGY**MICROBIOLOGY 001
INTRODUCTORY MICROBIOLOGY (UC:CSU)**

Prerequisites: BIOLOGY 3 or 6 or 36 and CHEM 51 or 101 with a grade of "C" or better

1645	lec	7:30am - 9:00am	MW	S.M. HOSSEINI	K 408
&	lab	9:00am - 12:20pm	MW	S.M. HOSSEINI	K 408

**MICROBIOLOGY 020
GENERAL MICROBIOLOGY (UC:CSU)**

Prerequisites: BIOLOGY 3 or 6 or 36 and CHEM 51 or 101 with a grade of "C" or better

1648	lec	8:30am - 11:40am	T	M.C. PANTASTICO CALDAS	K 408
&	lab	8:30am - 11:40am	Th	M.C. PANTASTICO CALDAS	K 408

Los Angeles Trade-Technical College Fall 2010

1. Steps in the Financial Aid Application Process
2. Ability to Benefit Test (ATB)
3. BOGG Fee Waiver Application
4. LATTC Educational Programs & Certificates
5. Application for Admission

At Los Angeles Trade-Technical College, getting the information, forms, and assistance you need is as easy as going online (www.lattc.edu), or in person!

Online



In person



WEB ENROLLMENT

Effective Jan 1, 2010 our STEP telephone registration system will be terminated. For students who do not have computer access at home, the campus computer labs are available for online registration. You can also ask for direct assistance in the Admissions Office in ST-Lobby.

Welcome to Los Angeles Trade Tech's Web Enrollment Program.

Continuing students will receive notifications with personal appointment date and time of web registration for Fall, 2010. This is a priority date based on the number of UNITS you have completed at Los Angeles Trade-Technical College. Visit our website for your appointment.

Residence Requirements

California Residence Requirement for Tuition Purposes

A student shall be classified as California Residents for enrollment fee purposes if he/she qualifies for option #1 or option #2:

Option #1: He/She is a U.S. Citizen and has been a legal resident of the state of California for one year and one day prior to the beginning of the semester.

Option #2: He/she is not a U.S. Citizen, but has taken the first step toward acquiring an immigration status that would allow him/her to permanently reside in the U.S. at least one year and one day prior to the beginning of the semester.

—AND—

He/she has been a legal resident of the state of California for one year and one day prior to the beginning of the semester. The information given by each student is subject to certification.

District Residence Requirement

At the time of application each student is required to file a Statement of Residence to ascertain the college district jurisdiction in order to comply with requirements of the law. The information given by each student is subject to certification, and any falsification can result in immediate cancellation of registration and exclusion from the College.

Residence More than 60 Miles From Nearest College

Full time students under 21 years of age and honorably discharged veterans under 25 years of age who live 60 miles from the nearest college are eligible for a maintenance allowance. See Registrar for additional information.

IMPORTANT INFORMATION: Effective January 2002, all students regardless of their immigration status, who meet all the requirements set under the new law AB 540, can be exempted from Non-Resident Tuition. Please see Admissions & Records Office, ST-Lobby, for details..



Los Angeles Trade-Tech College

HONORS

The Honors program provides highly motivated students with an intellectually challenging educational experience designed to prepare them for a successful transition from community college to university.

Why enroll?

- Priority consideration when transferring
- More competitive application will contain references to and evidence of Honors participation
- Help ensure smoother transition to 4 year college or university

Program Includes:

- Honors library
- Honors club

Program Includes:

- Minimum 3.25 GPA in high school course work, or a minimum of 3.25 in at least 6 UNITS of college course work, verified by transcripts and LATTC counselor.
- Eligibility for English 101
- Completion of Honors Program application
- Letter of recommendation from English Instructor or submission of research paper

More information is available at lisamoreno.net

The Transfer Advantage!



TAKE COURSES HERE comparable to courses at Cal State, the UC system or private schools such as USC for only \$26 per unit. A 3-unit course at LATTC cost \$78 plus fees. The same course at a four-year school will range from \$160 to \$4200 plus fees!

MAKE EVERY COURSE COUNT! A transfer plan will not only help you to meet graduation requirements here at LATTC, but also for the four-year school you're planning to attend. You can also prepare for your four-year major now. That means you can transfer as a junior, have all your lower division major courses and general education completed and have an A.A. degree in Liberal Arts at the same time!

COME TO THE UNIVERSITY TRANSFER CENTER IN ST-203, to meet with a counselor, visit with a university representative or sign up for a trip or workshop today. Office Hours: Monday- 9:00 a.m. to 6:00 p.m., Tuesday- 9:00 a.m. to 3:30 p.m., Wednesday- 9:00 a.m. to 3:00 p.m., Thursday 9:00 a.m. to 4:00 p.m., and Friday 9:00 a.m. to 1:00 p.m. Telephone - (213) 763-7154.

Need Help?

Visit the **LEARNING SKILLS CENTER**

Room C-102 • (213) 763-3738 • www.lattc.edu/dept/tlsc/main.html



- Get help in basic skills reading, writing, and/or math
- Improve your grades
- Learn basic computer skills
- Use the computer to type papers and access online classes
- Receive tutoring
- Prepare for various tests such as the Abilities To Benefit, ACT Compass, Accuplacer, Nursing, GED, etc.
- Master English, math, and other skills such as times tables
- Develop better study skills strategies

Learning Skills Computer Lab:

The Learning Skills Computer Lab is available to students taking Learning Skills courses or using the lab for instructional purposes. The Learning Skills Lab is located in C-102. Knowledgeable and friendly faculty, staff, and tutors are available to assist students with various types of instructional software including, such as:

- Ainsworth and Greg College Keyboarding (Typing)
- GED Official Practice Tests by Steck-Vaughn (For GED preparation)
- Informal Reading & Arithmetic Tests
- KeyTrain (Online basic workplace skills training)
- Moodle (Portal for most LATTTC online classes)
- PLATO (Basic reading, writing, math, spelling – beginning to advanced)
- Reading Horizons (Phonics to beginning reading)
- Rosetta Stone (ESL listening, speaking, and writing)
- Steck-Vaughn Read On! (Beginning to advanced reading)
- Windows & Mouse Tutorial (Computer literacy)

Fall & Spring Hours:

Mon-Thur 8am-8pm
Fri 8am-2pm
Saturday 9am-1pm

Winter & Summer Hours:

Mon-Thur 8am-7pm
Fri 8am-2pm

Hours may vary during holidays

Open Computer Lab:

The Open Computer Lab, located in C-109, offers general computer usage including Internet and online class access. The Open Lab has a laser printer, scanner, and the latest software.

Learning Skills Classes:

Learning Skills offers non-degree applicable, for-credit classes to help students improve their basic reading, writing, math, and/or computer literacy skills.

Tutoring Center:

The Tutoring Center, located in C-102, provides tutorial services, both individually and in small groups.

Writing Center:

The Writing Center, located in C-100, offers assistance to students interested in improving their writing skills.



**All students must be enrolled at LATTTC and have a current LATTTC student ID card to use all Learning Skills facilities.*

THE FINANCIAL AID APPLICATION PROCESS

STUDENTS MUST REAPPLY FOR EACH ACADEMIC YEAR
APPLICATIONS ARE AVAILABLE YEAR-ROUND

- Step 1** The student submits their **FAFSA (Free Application for Federal Student Aid) or Renewal** via:
- FAFSA on line at www.fafsa.ed.gov;
 - Download the FAFSA form at www.FederalStudentAid.ed.gov; or
 - Call toll free at 1-800-433-3243 to request your own paper FAFSA.
- Application assistance is available in the Financial Aid Computer Lab located in the K-Building Basement, Room K004*
- Step 2** The Federal Processor receives and processes the student's FAFSA.
- Step 3** In approximately two weeks, a paper Student Aid Report (SAR) is mailed or e-mailed to the student. *(e-mail address must have been provided on the FAFSA).*
- Step 4** Los Angeles Trade Technical College (LATTC) Financial Aid Office sends a Tracking Letter to the student, listing items required to complete their Financial Aid file and begin processing.
- Step 5** The student brings the requested documents/items to the LATTC Financial Aid Office, located in ST-214.
- Step 6** LATTC mails an Award Notification Letter to the student, showing their Financial Aid eligibility based on full time enrollment. The actual award amount disbursed is adjusted each semester based on actual UNITS enrolled.
- Step 7** LATTC mails Financial Aid checks starting the first week of Fall semester for students who completed their Financial Aid file by the priority date of May 1st. Students who miss the priority processing deadline can expect to receive their checks at least 4 to 6 weeks after their file is completed.



Have you applied for Financial Aid?

If not, Fee Waiver and Free Application for Federal Student Aid (FAFSA) are still available. Los Angeles Trade Technical College offers over **\$15 million** of Federal and State Financial Aid each year!

You **may** be eligible to receive Fee Waiver and/or Financial Aid even if:

- You are working
- You are receiving welfare
- You enrolled in only one class
- You were not eligible in the past

Come to the Financial Aid Office and Lab for further assistance!

Phone: (213) 763-7082

Office Hours:

Monday-Friday 9:00 am to 2:00 pm

Monday-Thursday 4:30 pm to 7:30 pm

Location: Student Services Building, ST-214

Lab Hours:

Monday-Friday 10:00 am to 2:00 pm

Monday-Thursday 4:30 pm to 6:00 pm

Location: Student Services Building, ST-314

THE ABILITY TO BENEFIT (ATB) TEST

FOR FEDERAL FINANCIAL AID



Assessment Center

(213) 763-5339

Location:

Building ST-303

Office Hours:

Monday: 8:30 a.m. - 5:00 p.m.

Tuesday: 8:30 a.m. - 5:00 p.m.

Wednesday: 8:30 a.m. - 8:00 p.m.

Thursday: 8:30 a.m. - 5:00 p.m.

Friday: 8:30 a.m. - 2:00 p.m.

Please REMEMBER that during testing:

- No food or drinks
- No children
- No calculators
- Cell phones and pagers MUST be turned OFF

The Ability To Benefit (ATB) Test is the same computerized assessment test offered during the enrollment process. The ATB test is used for students lacking a high school diploma or its equivalent who wish to apply for financial aid. This is not applicable to students who are currently enrolled in high school.

Students are tested on basic skills in Mathematics and English (or English as a Second Language, ESL). The test is not timed but students should allow themselves at least two hours to complete. Printed results of the test are given to the student after completion. To be eligible for financial aid, students must pass the three (3) test sections: Reading Comprehension, Sentence Skills, and Arithmetic. The scores are as follows:

Students who completed the native English speakers test:

Reading Skills	55
Sentence Meaning	60
Arithmetic	34
Total possible points per section:	120

Students who completed the English as a Second Language (ESL) test:

Reading	70
Grammar Usage	64
Listening	70
Total possible points per section:	99

Since this is a pass or fail test, it is recommended to review skills in these subjects prior to taking the assessment test. For sample questions go to: http://www.testprepreview.com/accu-placer_practice.htm

Students must bring a valid photo ID in order to take the test. There are NO EXCEPTIONS to this policy! The ID must be original, NO photocopies. Examples of ID include a California Driver's License, California ID, a passport, high school picture ID, etc.

Students that do not pass the ATB Test the first time may take it again. Please see below for retesting policy.

Test 1 ATBNO: Student can retest after 28 days.

Test 2 ATBNO: Student can retest after receiving a passing grade of "C" or better in English, Math, or Learning Skills class.

Test 3 ATBNO: Student can retest after one (1) year from original test date.

California Community Colleges 2010-2011 Board of Governors Fee Waiver Application

*This is an application to have your **ENROLLMENT FEES WAIVED**. This **FEE WAIVER** is for California residents only. If you need money to help with books, supplies, food, rent, transportation and other costs, please complete a **FREE APPLICATION FOR FEDERAL STUDENT AID (FAFSA)** immediately. Contact the Financial Aid Office for more information. **The FAFSA is available at www.fafsa.ed.gov or at the Financial Aid Office.***

Note: Students who are exempt from paying nonresident tuition under **Education Code Section 68130.5 (AB 540)** are NOT California residents. If you are NOT a California resident, you are not eligible for a fee waiver. Do not complete this application. You may apply for financial aid by completing the FAFSA.

Name: _____ <small style="display: block; text-align: center; margin-left: 100px;">Last First Middle Initial</small>	Student ID # _____
Email (if available): _____	Telephone Number: (____) _____
Home Address: _____ <small style="display: block; text-align: center; margin-left: 100px;">Street City Zip Code</small>	Date of Birth: _____/_____/_____
Has the Admissions or Registrar's Office determined that you are a California resident? <input type="checkbox"/> Yes <input type="checkbox"/> No	

IMPLEMENTATION OF THE CALIFORNIA DOMESTIC PARTNER RIGHTS AND RESPONSIBILITIES ACT

The California Domestic Partner Rights and Responsibilities Act extends new rights, benefits, responsibilities and obligations to individuals in domestic partnerships registered with the California Secretary of State under Section 297 of the Family Code. If **you** are in a Registered Domestic Partnership (RDP), you will be treated as an Independent married student to determine eligibility for this Enrollment Fee Waiver and will need to provide income and household information for your domestic partner. If you are a dependent student and your parent is in a Registered Domestic Partnership, you will be treated the same as a student with married parents and income and household information will be required for the parent's domestic partner.

Note: These provisions apply to state student financial aid ONLY, and not to federal student financial aid.

Are you or your parent in a Registered Domestic Partnership with the California Secretary of State under Section 297 of the Family Code? (Answer "Yes" if you or your parent are separated from a Registered Domestic Partner but have **NOT FILED** a Notice of Termination of Domestic Partnership with the California Secretary of State's Office.) Yes No

If you answered "Yes" to the question above treat the Registered Domestic Partner as a spouse. You are required to include your domestic partner's income and household information or your parent's domestic partner's income and household information in Questions 4, 11, 12, 13, 14, 15, 16, 17.

Student Marital Status: Single Married Divorced Separated Widowed Registered Domestic Partnership

DEPENDENCY STATUS

The questions below will determine whether you are considered a Dependent student or Independent student for fee waiver eligibility and whether parental information is needed. If you answer "Yes" to **ANY** of the questions 1-10 below, you will be considered an INDEPENDENT student. If you answer "No" to all questions, you will be considered a Dependent student thereby reporting parental information and should continue with Question 11.

1. Were you born before January 1, 1987? (If "Yes," skip to question 13) Yes No
2. As of today, are you married **or** in a Registered Domestic Partnership (RDP)?
(Answer "Yes" if you are separated but not divorced or have not filed a termination notice to dissolve partnership. Also, if you answer "Yes," skip to question 13.) Yes No
3. Are you a veteran of the U.S. Armed Forces **or** currently serving on active duty for purposes other than training? (If "Yes," skip to question 13) Yes No
4. Do you have children who will receive more than half of their support from you between July 1, 2010-June 30, 2011, **or** other dependents who live with you (other than your children and spouse/RDP) who receive more than half of their support from you, now and through June 30, 2011? (If "Yes," skip to question 13) Yes No
5. At any time since you turned age 13, were both your parents deceased, were you in foster care or were you a dependent or ward of the court? (If "Yes," skip to question 13) Yes No
6. Are you or were you an emancipated minor as determined by a court in your state of legal residence? (If "Yes," skip to question 13) Yes No

DEPENDENCY STATUS (Continued)

7. Are you or were you in legal guardianship as determined by a court in your state of legal residence?
(If "Yes," skip to question 13) Yes No
8. At any time on or after July 1, 2009, did your high school or school district homeless liaison determine that you were an unaccompanied youth who was homeless? (If "Yes," skip to question 13) Yes No
9. At any time on or after July 1, 2009, did the director of an emergency shelter or transitional housing program funded by the U.S. Department of Housing and Urban Development determine that you were an unaccompanied youth who was homeless?
(If "Yes," skip to question 13) Yes No
10. At any time on or after July 1, 2009, did the director of a runaway or homeless youth basic center or transitional living program determine that you were an unaccompanied youth who was homeless or were self-supporting and at risk of being homeless?
(If "Yes," skip to question 13) Yes No

• If you answered "Yes" to any of the questions 1 - 10, you are considered an **INDEPENDENT** student for enrollment fee waiver purposes and must provide income and household information about yourself (and your spouse or RDP if applicable). Skip to Question #13.

• If you answered "No" to all questions 1 - 10, complete the following questions:

11. If your parent(s) or his/her RDP filed or will file a 2009 U.S. Income Tax Return, were you, or will you be claimed on their tax return as an exemption by either or both of your parents? Will Not File Yes No
12. Do you live with one or both of your parent(s) and/or his/her RDP? Yes No

• If you answered "No" to questions 1 - 10 and "Yes" to either question 11 or 12, you must provide income and household information about your **PARENT(S)/RDP**. Please answer questions for a **DEPENDENT** student in the sections that follow.

• If you answered "No" or "Parent(s) will not file" to question 11, and "No" to question 12, you are a dependent student for all student aid except this enrollment fee waiver. You may answer questions as an **INDEPENDENT** student on the rest of this application, but please try to get your **PARENT** information and file a **FAFSA** so you may be considered for other student aid. You cannot get other student aid without your parent(s)' information.

METHOD A ENROLLMENT FEE WAIVER

13. Are you (the student **ONLY**) currently receiving monthly cash assistance for yourself or any dependents from:
- TANF/CalWORKs? Yes No
- SSI/SSP (Supplemental Security Income/State Supplemental Program)? Yes No
- General Assistance? Yes No
14. If you are a dependent student, are your parent(s)/RDP receiving monthly cash assistance from TANF/CalWORKs or SSI/SSP as a primary source of income? Yes No

• If you answered "Yes" to question 13 or 14 you are eligible for an **ENROLLMENT FEE WAIVER**. Sign the Certification at the end of this form. You are required to show current proof of benefits. Complete a **FAFSA** to be eligible for other financial aid opportunities.

METHOD B ENROLLMENT FEE WAIVER

15. **DEPENDENT STUDENT:** How many persons are in your parent(s)/RDP household? (Include yourself, your parent(s)/RDP, and anyone who lives with your parent(s)/RDP and receives more than 50% of their support from your parents/RDP, now and through June 30, 2011.) _____
16. **INDEPENDENT STUDENT:** How many persons are in your household? (Include yourself, your spouse/RDP, and anyone who lives with you and receives more than 50% of their support from you, now and through June 30, 2011.) _____
17. **2009 Income Information**

	DEPENDENT STUDENT: PARENT(S)/ RDP INCOME ONLY	INDEPENDENT STUDENT: STUDENT (& SPOUSE'S/ RDP) INCOME
(Dependent students should not include their income information for Q 17 a and b below.)		
a. Adjusted Gross Income (If 2009 U.S. Income Tax Return was filed, enter the amount from Form 1040, line 37; 1040A, line 21; 1040EZ, line 4).	\$ _____	\$ _____
b. All other income (Include ALL money received in 2009 that is not included in line (a) above (such as disability, child support, military living allowance, Workman's Compensation, untaxed pensions).	\$ _____	\$ _____
TOTAL Income for 2009 (Sum of a + b)	\$ _____	\$ _____

The Financial Aid Office will review your income and let you know if you qualify for an ENROLLMENT FEE WAIVER under Method B. If you do not qualify using this simple method, you should file a FAFSA.

SPECIAL CLASSIFICATIONS ENROLLMENT FEE WAIVERS

18. Do you have certification from the CA Department of Veterans Affairs that you are eligible for a dependent's fee waiver?
Submit certification. Yes No
19. Do you have certification from the National Guard Adjutant General that you are eligible for a dependent's fee waiver?
Submit certification. Yes No
20. Are you eligible as a recipient of the Congressional Medal of Honor or as a child of a recipient?
Submit documentation from the Department of Veterans Affairs. Yes No
21. Are you eligible as a dependent of a victim of the September 11, 2001, terrorist attack?
Submit documentation from the CA Victim Compensation and Government Claims Board. Yes No
22. Are you eligible as a dependent of a deceased law enforcement/fire suppression personnel killed in the line of duty?
Submit documentation from the public agency employer of record. Yes No

• If you answered "Yes" to any of the questions from 18-22, you are eligible for an ENROLLMENT FEE WAIVER and perhaps other fee waivers or adjustments. Sign the Certification below. Contact the Financial Aid Office if you have questions.

CERTIFICATION FOR ALL APPLICANTS: READ THIS STATEMENT AND SIGN BELOW

I hereby swear or affirm, under penalty of perjury, that all information on this form is true and complete to the best of my knowledge. **If asked by an authorized official, I agree to provide proof of this information, which may include a copy of my and my spouse/registered domestic partner and/or my parent's/registered domestic partner's 2009 U.S. Income Tax Return(s).** I also realize that any false statement or failure to give proof when asked may be cause for the denial, reduction, withdrawal, and/or repayment of my waiver. I authorize release of information regarding this application between the college, the college district, and the Chancellor's Office of the California Community Colleges.

I understand the following information (please check each box):

- Federal and state financial aid programs are available to help with college costs (including enrollment fees, books & supplies, transportation and room and board expenses). By completing the FAFSA, additional financial assistance may be available in the form of Pell and other grants, work study and other aid.
- I may apply for and receive financial assistance if I am enrolled, either full time or part time, in an eligible program of study (certificate, associate degree or transfer).
- Financial aid program information and application assistance is available in the college financial aid office.

Applicant's Signature

Date

Parent Signature (Dependent Students Only)

Date

CALIFORNIA INFORMATION PRIVACY ACT

State and federal laws protect an individual's right to privacy regarding information pertaining to oneself. The California Information Practices Act of 1977 requires the following information be provided to financial aid applicants who are asked to supply information about themselves. The principal purpose for requesting information on this form is to determine your eligibility for financial aid. The Chancellor's Office policy and the policy of the community college to which you are applying for aid authorize maintenance of this information. Failure to provide such information will delay and may even prevent your receipt of financial assistance. This form's information may be transmitted to other state agencies and the federal government if required by law. Individuals have the right of access to records established from information furnished on this form as it pertains to them.

The officials responsible for maintaining the information contained on this form are the financial aid administrators at the institutions to which you are applying for financial aid. The SSN may be used to verify your identity under record keeping systems established prior to January 1, 1975. If your college requires you to provide an SSN and you have questions, you should ask the financial aid officer at your college for further information. The Chancellor's Office and the California community colleges, in compliance with federal and state laws, do not discriminate on the basis of race, religion, color, national origin, gender, age, disability, medical condition, sexual orientation, domestic partnership or any other legally protected basis. Inquiries regarding these policies may be directed to the financial aid office of the college to which you are applying.

FOR OFFICE USE ONLY

<input type="checkbox"/> BOGFW-A <input type="checkbox"/> TANF/CalWORKs <input type="checkbox"/> GA <input type="checkbox"/> SSI/SSP	<input type="checkbox"/> BOGFW-B _____ <input type="checkbox"/> BOGFW-C	<input type="checkbox"/> Special Classification <input type="checkbox"/> Veteran <input type="checkbox"/> Medal of Honor <input type="checkbox"/> Dep. of deceased law enforcement/fire personnel	<input type="checkbox"/> National Guard Dependent <input type="checkbox"/> 9/11 Dependent	RDP <input type="checkbox"/> Student <input type="checkbox"/> Parent	<input type="checkbox"/> Student is not eligible
---	---	--	---	--	--

Comments: _____

Certified by: _____ **Date:** _____

LOS ANGELES COMMUNITY COLLEGE DISTRICT

APPLICATION FOR ADMISSION

Please type or print clearly in black ink

<p>1. Student Identification Number (Leave blank unless you have previously been assigned a Student Identification Number)</p> <p>8 8</p>		<p>3. Legal Name</p> <p>Last First Middle Initial</p> <p>List other names you have used. If none, check box: <input type="checkbox"/></p> <p>Last First Middle Initial</p>	
<p>2. Social Security Number</p> <p>Students are required by law to provide their Social Security Number, which will be used for reporting to the federal government under the Taxpayer Relief Act of 1997 and for financial aid verification. If you do not have a Social Security number, or if you do not wish to use it, please leave blank.</p>		<p>4. Legal Address/Residence (Do not use P.O. Box or Business Address)</p> <p>Number Street Apt. No.</p> <p>City State Zip Code</p> <p>Have lived at this address since: _____ Month _____ Day _____ Year _____</p>	
<p>9. If you have lived at your present address fewer than two years, list previous addresses)</p> <p>Number/Street/Apt. No. City/State FROM: Mo/Yr TO: Mo/Yr</p> <p>Number/Street/Apt. No. City/State FROM: Mo/Yr TO: Mo/Yr</p>		<p>13. Contact Information</p> <p>Primary Telephone: (_____) _____ Area Code _____ Number _____</p> <p>E-mail: _____</p>	
<p>10. Mailing Address (if different from Legal Address given above)</p> <p>Number/Street/Apt. No. City/State Zip Code</p>		<p>14. Place of Birth</p> <p>City State or Foreign Country</p>	
<p>11. My present stay in California began on:</p> <p>Are any of the following on active military duty? (Please check all that apply)</p> <p><input type="checkbox"/> Yourself <input type="checkbox"/> Spouse <input type="checkbox"/> Parents</p>		<p>15. Full name of the most recent High School you attended</p> <p>Name of High School _____ State or Foreign Country _____</p> <p>City _____ State or Foreign Country _____</p>	
<p>12. The questions below must be answered by every applicant. At any time in the past two years have you:</p> <p>(If you are under 19, answer for your parents)</p> <p>* Registered to vote in a state other than California? Yes No If yes, what year? _____</p> <p>* Filled a legal action in a state other than California? Yes No If yes, what year? _____</p> <p>* Attended a non-California college/university as a resident of that state? Yes No If yes, what year? _____</p> <p>* Filed as a Non-Resident for California State Income Tax Purposes? Yes No If yes, what year? _____</p>		<p>16. Last College attended. If none, check box: <input type="checkbox"/></p> <p>Name of College _____ Dates Attended _____</p> <p>City/State/Foreign Country _____ Degree Awarded _____</p>	
<p>The LACCD is made up of the following schools. Please check ONE school.</p> <p><input type="checkbox"/> City <input type="checkbox"/> East <input type="checkbox"/> Harbor <input type="checkbox"/> Mission <input type="checkbox"/> Pierce</p> <p><input type="checkbox"/> Southwest <input type="checkbox"/> Trade Tech <input type="checkbox"/> Valley <input type="checkbox"/> West LA <input type="checkbox"/> ITV</p>		<p>17. I am a citizen of _____</p> <p>Country _____</p>	
<p>18. If you are not a United States Citizen, please circle and complete:</p> <p>2. Permanent Resident Alien 3. Temporary Resident Alien 4. Refugee, Asylee 5. Student Visa (F-1 or M-1 visa) 6. Other (Specify): _____ 7. Visitor Visa (B-1 or B-2 visa)</p> <p>Permanent Resident or Visa Number _____ Issue/Adjustment Date _____</p>		<p>5. Alternate Identification Number</p> <p>If you are a returning student and have been previously assigned an Alternate Identification Number by the district, please complete. Otherwise leave blank.</p> <p>_____</p>	
<p>6. This application is for:</p> <p>Fall <input type="checkbox"/> Winter <input type="checkbox"/></p> <p>Spring <input type="checkbox"/> Summer <input type="checkbox"/></p> <p>Year _____</p>		<p>7. Sex</p> <p>Female <input type="checkbox"/></p> <p>Male <input type="checkbox"/></p>	
<p>8. Birth Date</p> <p>Month _____ Day _____ Year _____</p>		<p>Age</p> <p>_____</p>	
<p>OFFICE USE ONLY</p> <p>Residence _____</p> <p>Marriage/Annulment _____</p> <p>High School _____</p> <p>College _____</p> <p>Concurrent _____</p>			

CONTINUE ON OTHER SIDE

<p>19. Complete this question only if you are under 19 and have never been married.</p> <p>Name of Parent or Legal Guardian: _____</p> <p>Relationship to you: <input type="checkbox"/> Father <input type="checkbox"/> Mother <input type="checkbox"/> Legal Guardian <input type="checkbox"/> Other _____</p> <p>Is the person a: <input type="checkbox"/> U.S. Citizen <input type="checkbox"/> Permanent Resident Alien <input type="checkbox"/> Other _____</p> <p>If a Permanent Resident Alien, enter "A-Number" and date of issue: _____</p> <p>Current residence of this person: _____ From: _____ To: PRESENT State Month/Year</p>	<p>24. Highest Education Status: Please enter number and year in boxes below</p> <p>1 = Earned a U.S. High School diploma (or will earn one before college semester begins) _____</p> <p>2 = Enrolled in grade 12 or below when college semester begins _____</p> <p>3 = Not a High School graduate, currently enrolled in adult school _____</p> <p>4 = Not a High School graduate, last attended High School _____ Number</p> <p>5 = Passed the GED or received a certificate of H.S. equivalency _____</p> <p>6 = Earned California High School Proficiency Certificate _____</p> <p>7 = Earned a Foreign Secondary diploma or certificate of graduation _____ Year</p> <p>8 = Earned an Associate degree _____</p> <p>9 = Earned a Bachelor's or higher degree _____</p>
<p>20. Ethnic Identity (*) Please enter number in box _____</p> <p>10 = Chinese 20 = Black, African-American 60 = American Indian, Alaskan Native</p> <p>11 = Japanese 30 = Filipino 70 = Pacific Islander, Samoan</p> <p>12 = Korean 40 = Mexican, Chicano, 71 = Pacific Islander, Hawaiian</p> <p>13 = Laotian 50 = Mexican-American 72 = Pacific Islander, Guamanian</p> <p>14 = Cambodian 41 = Central American 73 = Other Pacific Islander</p> <p>15 = Vietnamese 42 = South American 74 = Other Non-White</p> <p>16 = Indian Sub-Continent 43 = Other Hispanic 80 = Decline to state</p> <p>17 = Other Asian 44 = Caucasian, White 90 = _____</p>	<p>25. Enrollment Status: Please enter number in box _____</p> <p>1 = First time college student _____</p> <p>2 = First time at this college, after attending another college _____</p> <p>3 = Returning to this college, after attending another college _____</p> <p>4 = Returning to this college, without having attended another college _____</p> <p>5 = Enrolling in this college, while attending school in the 12th or lower grade _____</p> <p>26. College Units or degree completed by first day of this term</p> <p>Please enter number in box _____</p> <p>1 = 0 units 4 = 30 to 59 1/2 _____</p> <p>2 = 1 1/2 to 15 1/4 5 = 60 or more units, no degree _____</p> <p>3 = 16 to 29 1/2 6 = A.A., A.S., B.A., B.S. or higher degree _____</p>
<p>21. What is your primary language? (*) Please enter number in box _____</p> <p>1 = English 5 = Filipino 9 = Spanish _____</p> <p>2 = Armenian 6 = Japanese 10 = Vietnamese _____</p> <p>3 = Chinese 7 = Korean 11 = Other language _____</p> <p>4 = Farsi 8 = Russian _____</p>	<p>27. Veteran (Leave blank, unless you are a veteran) _____</p> <p>Were you honorably discharged from the U.S. Armed Forces? <input type="checkbox"/> Yes <input type="checkbox"/> No</p>
<p>22. What is your main educational goal? Please enter number in box _____</p> <p>1 = Prepare for a new career (acquire new job skills) _____</p> <p>2 = Advance in current job/career (update job skills) _____</p> <p>3 = Discover/develop career interests, plans and goals _____</p> <p>4 = Obtain a two-year vocational degree without transfer _____</p> <p>5 = Obtain a two-year Associate degree without transfer _____</p> <p>6 = Obtain a vocational certificate without transfer _____</p> <p>7 = Obtain a Bachelor's degree after completing an Associate's degree _____</p> <p>8 = Obtain a Bachelor's degree without completing an Associate's degree _____</p> <p>9 = Maintain certificate or license (e.g. Nursing, Real Estate) _____</p> <p>10 = Improve basic skills in English, reading or math _____</p> <p>11 = Complete credits for high school diploma or GED _____</p> <p>12 = Personal development (intellectual, cultural) _____</p> <p>13 = Undecided on goal _____</p>	<p>28. Student Information -- Permission to Release</p> <p>TYPES OF STUDENT INFORMATION: (1) <i>Directory Information:</i> name; city of residence; participation in officially recognized activities and sports; weight and height of athletic team members; dates of attendance; degrees and awards received; and the most recent previous educational institution attended. (2) <i>College Foundation Information:</i> name, address, and telephone number. (3) <i>Four-year College Information:</i> name, address, and phone number. (4) <i>Military Recruiting Information:</i> "Directory information", plus address, telephone number, date of birth, and major field of study.</p> <p><input type="checkbox"/> I DO NOT permit the release of directory information</p> <p><input type="checkbox"/> I DO NOT permit the release of information to the College Foundation</p> <p><input type="checkbox"/> I DO NOT permit the release of information to four-year colleges</p> <p><input type="checkbox"/> I DO NOT permit the release of information to the military</p> <p>You may change your Directory Release at any time by completing a Release of Directory Information form and returning it to the Admissions Office.</p>
<p>23. Special Services (*)</p> <p>The Los Angeles Community College District is committed to increasing your educational success. Each area listed below provides special services. Please indicate those services that interest you.</p> <p>1. <input type="checkbox"/> Financial Aid 5. <input type="checkbox"/> Employment Assistance</p> <p>2. <input type="checkbox"/> Child Care 6. <input type="checkbox"/> Information regarding special services and/or accommodations for students with disabilities may be obtained from the Disabled Student Programs (DSPS) Office.</p> <p>3. <input type="checkbox"/> Tutoring</p> <p>4. <input type="checkbox"/> Transfer Assistance 7. Are you from a low income family and in need of special counseling, tutoring, and/or financial aid assistance? <input type="checkbox"/> Yes <input type="checkbox"/> No</p>	<p>29. Certification</p> <p>I declare under penalty of perjury that all information on this form is correct. I understand that falsifying or withholding information required on this form shall constitute grounds for dismissal.</p> <p>REQUIRED SIGNATURE _____ Date _____</p>

1658	lec	12:30pm - 3:40pm	M	R.K. WONG	K 408
&	lab	12:30pm - 3:40pm	W	R.K. WONG	K 408
Evening Class					
4060	lec	6:00pm - 9:10pm	M	S. ABDULMALEK	K 408
&	lab	6:00pm - 9:10pm	W	S. ABDULMALEK	K 408

MICROCOMPUTER TECHNICIAN

MICROCOMPUTER TECHNICIAN 077 CISCO NETWORKING ACADEMY - SEMESTER I 3.00 UNITS

0521	lec	7:00am - 12:35pm	T	R.W. CAMPBELL	E 200
Evening Class					
3351	lec	6:00pm - 8:05pm	T	R.W. CAMPBELL	E 200
&	lab	6:00pm - 9:10pm	Th	R.W. CAMPBELL	E 200

MICROCOMPUTER TECHNICIAN 078 CISCO NETWORKING ACADEMY - SEMESTER II 3.00 UNITS

0524	lec	7:00am - 9:05am	F	R.W. CAMPBELL	E 200
&	lab	9:25am - 12:35pm	F	R.W. CAMPBELL	E 200

MICROCOMPUTER TECHNICIAN 079 CISCO NETWORKING ACADEMY - SEMESTER III 3.00 UNITS

0527	lec	7:00am - 9:05am	F	R.W. CAMPBELL	E 200
&	lab	9:25am - 12:35pm	F	R.W. CAMPBELL	E 200

MICROCOMPUTER TECHNICIAN 080 CISCO NETWORKING ACADEMY - SEMESTER IV 3.00 UNITS

0529	lec	7:00am - 9:05am	F	R.W. CAMPBELL	E 200
&	lab	9:25am - 12:35pm	F	R.W. CAMPBELL	E 200

MICROCOMPUTER TECHNICIAN 160 IT ESSENTIALS APPLICATION SOFTWARE FUNDAMENTALS 2.00 UNITS

0531	lec	7:00am - 9:00am	W	E.L. CHAVEZ	E 106
&	lab	9:00am - 11:25am	W	E.L. CHAVEZ	E 105

MICROCOMPUTER TECHNICIAN 162 IT ESSENTIALS NETWORKING PERSONAL COMPUTERS 4.00 UNITS

0533	lec	7:00am - 10:00am	T	E.L. CHAVEZ	E 104
&	lab	10:10am - 12:30pm	T	E.L. CHAVEZ	E 104
&	lab	7:00am - 10:00am	Th	E.L. CHAVEZ	E 104

MICROCOMPUTER TECHNICIAN 164 IT ESSENTIALS MICROCOMPUTER THEORY AND SERVICING 5.00 UNITS

0535	lec	7:00am - 10:00am	M	E.L. CHAVEZ	E 105
&	lab	10:10am - 1:00pm	M	E.L. CHAVEZ	E 106
&	lab	10:10am - 1:20pm	TTh	E.L. CHAVEZ	E 106

MICROCOMPUTER TECHNICIAN 165 LINUX SURVIVAL COURSE (UC:CSU) 3.00 UNITS

Evening Class					
3364	lec	6:00pm - 8:05pm	T	R.W. CAMPBELL	E 200
&	lab	6:00pm - 9:10pm	Th	R.W. CAMPBELL	E 200

MOTORCYCLE REPAIR MECHANIC

MOTORCYCLE REPAIR MECHANIC 210 4.00 UNITS INTERNAL COMBUSTION ENGINE THEORY AND REPAIR

7496	lab	7:30am - 8:30am	S	R.R. PRICE	F 124
&	lab	8:30am - 1:40pm	S	R.R. PRICE	F 124
Evening Class					
4500	lec	6:30pm - 7:30pm	TTh	R.R. PRICE	F 124
&	lab	7:30pm - 9:40pm	TTh	R.R. PRICE	F 124

MOTORCYCLE REPAIR MECHANIC 212 4.00 UNITS MOTORCYCLE SERVICE AND TUNE-UP THEORY AND REPAIR

7497	lab	7:30am - 8:30am	S	R.R. PRICE	F 124
&	lab	8:30am - 1:40pm	S	R.R. PRICE	F 124
Evening Class					
4501	lec	6:30pm - 7:30pm	TTh	R.R. PRICE	F 124
&	lab	7:30pm - 9:40pm	TTh	R.R. PRICE	F 124

MOTORCYCLE REPAIR MECHANIC 214 4.00 UNITS MULTI-CYLINDER ELECTRICAL PRINCIPLES AND REPAIR

7498	lab	7:30am - 8:30am	S	R.R. PRICE	F 124
&	lab	8:30am - 1:40pm	S	R.R. PRICE	F 124
Evening Class					
4502	lec	6:30pm - 7:30pm	TTh	R.R. PRICE	F 124
&	lab	7:30pm - 9:40pm	TTh	R.R. PRICE	F 124

MOTORCYCLE REPAIR MECHANIC 216 4.00 UNITS MULTI-CYLINDER DIAGNOSIS AND OVERHAUL

7499	lab	7:30am - 8:30am	S	R.R. PRICE	F 124
&	lab	8:30am - 1:40pm	S	R.R. PRICE	F 124
Evening Class					
4503	lec	6:30pm - 7:30pm	TTh	R.R. PRICE	F 124
&	lab	7:30pm - 9:40pm	TTh	R.R. PRICE	F 124

MUSIC

MUSIC 101 3.00 UNITS FUNDAMENTALS OF MUSIC (UC:CSU)

1467	lec	10:10am - 11:45am	MW	M.B. WACHS	D 300
1469	lec	8:35am - 10:00am	MW	E.J. RAY	D 300
1471	lec	10:10am - 11:35am	TTh	E.D. HARMETZ	D 300
Evening Class					
3920	lec	5:00pm - 8:10pm	W	S. BAIK	D 300

MUSIC 141 3.00 UNITS JAZZ APPRECIATION (UC:CSU)

1473	lec	11:45am - 1:10pm	TTh	S.D. CANON	D 300
1575	lec	11:45am - 1:10pm	TTh	S.D. CANON	D 300

• Section #1575 - Honor section

MUSIC 321 **2.00 UNITS****ELEMENTARY PIANO I (UC:CSU)**

1464	lec	10:10am - 11:35am	TTh	S.D. CANON	D 350
1476	lec	8:35am - 10:00am	TTh	S.D. CANON	D 350

MUSIC 322 **2.00 UNITS****ELEMENTARY PIANO II (UC:CSU)**

1465	lec	10:10am - 11:35am	TTh	S.D. CANON	D 350
1477	lec	8:35am - 10:00am	TTh	S.D. CANON	D 350

MUSIC 323 **2.00 UNITS****ELEMENTARY PIANO III (UC:CSU)**

1466	lec	10:10am - 11:35am	TTh	S.D. CANON	D 350
1478	lec	8:35am - 10:00am	TTh	S.D. CANON	D 350

MUSIC 324 **2.00 UNITS****ELEMENTARY PIANO IV (UC:CSU)**

1468	lec	10:10am - 11:35am	TTh	S.D. CANON	D 350
1479	lec	8:35am - 10:00am	TTh	S.D. CANON	D 350

MUSIC 341 **2.00 UNITS****INTERMEDIATE PIANO (UC:CSU)**

1482	lec	10:10am - 11:35am	TTh	S.D. CANON	D 350
1484	lec	8:35am - 10:00am	TTh	S.D. CANON	D 350

MUSIC 650 **2.00 UNITS****BEGINNING GUITAR (UC:CSU)**

1490	lec	8:30am - 9:40am	S	J.M. CHEESMAN	F 234
&	lab	9:40am - 11:40am	S	J.M. CHEESMAN	F 234
1491	lec	8:30am - 9:40am	S	T.M. CARTER	F 235
&	lab	9:40am - 11:45am	S	T.M. CARTER	F 235

Evening Class

3923	lec	6:00pm - 9:10pm	M	E.J. RAY	D 300
------	-----	-----------------	---	----------	-------

NURSING SCIENCE**NURSING SCIENCE 101** **3.00 UNITS****INTRODUCTION TO NURSING (CSU)**

Prerequisites: Psychology 1 & 41

7724	lec	8:00am - 10:50am	Th	C.M. ASHBY	T-L 100
&	lab	7:00am - 1:30pm	WF	P. JOHNSON	WM MC

(8 Week Class - Starts 8/30/2010, Ends 10/22/2010)

- White Memorial Medical Center, 1720 Cesar E. Chavez Ave., Los Angeles, CA 90033.

7725	lec	8:00am - 10:50am	Th	C.M. ASHBY	T-L 100
&	lab	7:00am - 1:30pm	TW	C.M. ASHBY	CA HOSP

(8 Week Class - Starts 8/30/2010, Ends 10/22/2010)

- California Hospital, 1401 South Grand Ave., Los Angeles, CA 90015.

7726	lec	8:00am - 10:50am	Th	C.M. ASHBY	T-L 100
&	lab	7:00am - 1:30pm	TW	B. SOLES	OLYM MC

(8 Week Class - Starts 8/30/2010, Ends 10/22/2010)

- Olympia Medical Center, 5900 W. Olympic Center, Los Angeles, CA 90036.

7727	lec	8:00am - 10:50am	Th	C.M. ASHBY	T-L 100
&	lab	7:00am - 1:30pm	TW	R.C. VILLORA	CA HOSP

(8 Week Class - Starts 8/30/2010, Ends 10/22/2010)

- California Hospital, 1401 South Grand Ave., Los Angeles, CA 90015.

NURSING SCIENCE 102 **3.00 UNITS****FUNDAMENTALS OF NURSING**

7721	lec	8:00am - 10:50am	Th	C.M. ASHBY	T-L 100
&	lab	7:00am - 1:30pm	TW	B. SOLES	OLYM MC

(8 Week Class - Starts 10/25/2010, Ends 12/17/2010)

- Olympia Medical Center, 5900 W. Olympic Center, Los Angeles, CA 90036.

7723	lec	8:00am - 10:50am	Th	C.M. ASHBY	T-L 100
&	lab	7:00am - 1:30pm	TW	R.C. VILLORA	CA HOSP

(8 Week Class - Starts 10/25/2010, Ends 12/17/2010)

- California Hospital, 1401 South Grand Ave., Los Angeles, CA 90015.

7728	lec	8:00am - 10:50am	Th	C.M. ASHBY	T-L 100
&	lab	7:00am - 1:30pm	TW	C.M. ASHBY	CA HOSP

(8 Week Class - Starts 10/25/2010, Ends 12/17/2010)

- California Hospital, 1401 South Grand Ave., Los Angeles, CA 90015.

7729	lec	8:00am - 10:50am	Th	C.M. ASHBY	T-L 100
&	lab	7:00am - 1:30pm	WF	P. JOHNSON	H OSP

*(8 Week Class - Starts 10/25/2010, Ends 12/17/2010)***NURSING SCIENCE 103** **1.00 UNIT****NURSING PROCESS (UC:CSU)**

7765	lec	1:00pm - 3:10pm	Th	D.A. JENKINSON	T-L 100
------	-----	-----------------	----	----------------	---------

*(8 Week Class - Starts 8/30/2010, Ends 10/22/2010)***NURSING SCIENCE 104** **1.00 UNIT****NURSING COMMUNICATION**

7737	lec	1:00pm - 3:20pm	Th	R.L. WEINGOURT	T-L 100
------	-----	-----------------	----	----------------	---------

*(6 Week Class - Starts 10/25/2010, Ends 12/17/2010)***NURSING SCIENCE 105** **2.00 UNITS****NURSING PHARMACOLOGY**

7740	lec	8:00am - 9:45am	M	R.C. VILLORA	T-L 100
&	lab	10:00am - 11:10am	M	R.C. VILLORA	T-H 100

NURSING SCIENCE 106 **5.00 UNITS****MEDICAL-SURGICAL NURSING I**

7730	lec	1:00pm - 4:20pm	M	C.P. WASHINGTON	T-H 100
&	lec	9:00am - 12:20pm	W	C.P. WASHINGTON	T-H 100
&	lab	7:00am - 7:50pm	Th	C.P. WASHINGTON	CEDA SINA

(8 Week Class - Starts 8/30/2010, Ends 10/22/2010)

- Cedars Sinai Medical Center, 8700 Beverly Blvd., Los Angeles, CA 90048.

7731	lec	1:00pm - 4:20pm	M	C.P. WASHINGTON	T-H 100
&	lec	9:00am - 12:20pm	W	C.P. WASHINGTON	T-H 100
&	lab	7:00am - 7:50pm	Th	P. JOHNSON	PA MC

(8 Week Class - Starts 8/30/2010, Ends 10/22/2010)

- Pacific Alliance Medical Center, 531 College St., Los Angeles, CA 90012.

7732	lec	1:00pm - 4:20pm	M	C.P. WASHINGTON	T-H 100
&	lab	7:00am - 7:50pm	Th	C.P. WASHINGTON	CEDA SINA
&	lec	9:00am - 12:20pm	W	C.P. WASHINGTON	T-H 100

(8 Week Class - Starts 10/25/2010, Ends 12/17/2010)

7733	lec	1:00pm - 4:20pm	M	C.P. WASHINGTON	T-H 100
&	lab	7:00am - 7:50pm	Th	L.V. JACOBS	PA MC
&	lec	9:00am - 12:20pm	W	P. JOHNSON	T-H 100

(8 Week Class - Starts 10/25/2010, Ends 12/17/2010)

**NURSING SCIENCE 107
MEDICAL-SURGICAL NURSING II**

5.00 UNITS

7734	lec	9:00am - 12:20pm	M	M.D. KENDRICK	TH 100
&	lec	9:00am - 12:20pm	W	M.D. KENDRICK	TB 100
&	lab	7:00am - 7:50pm	T	M.D. KENDRICK	CA HOSP
<i>(8 Week Class - Starts 8/30/2010, Ends 10/22/2010)</i>					
• California Hospital, 1401 South Grand Ave., Los Angeles, CA 90015.					
7735	lec	9:00am - 12:20pm	M	M.D. KENDRICK	TH 100
&	lec	9:00am - 12:20pm	Th	M.D. KENDRICK	TH 100
&	lab	7:00am - 7:50pm	T	L.V. JACOBS	PA MC
<i>(8 Week Class - Starts 8/30/2010, Ends 10/22/2010)</i>					
• Pacific Alliance Medical Center, 531 College St., Los Angeles, CA 90012.					
7736	lec	9:00am - 12:20pm	M	M.D. KENDRICK	TH 100
&	lab	9:00am - 12:20pm	W	M.D. KENDRICK	TB 100
&	lab	7:00am - 7:50pm	T	M.D. KENDRICK	CA HOSP
<i>(8 Week Class - Starts 10/25/2010, Ends 12/17/2010)</i>					
• California Hospital, 1401 South Grand Ave., Los Angeles, CA 90015.					
7738	lec	9:00am - 12:20pm	M	M.D. KENDRICK	TH 100
&	lec	9:00am - 12:20pm	W	M.D. KENDRICK	TB 100
&	lab	7:00am - 7:50pm	T	L.V. JACOBS	PA MC
<i>(8 Week Class - Starts 10/25/2010, Ends 12/17/2010)</i>					
• Pacific Alliance Medical Center, 531 College St., Los Angeles, CA 90012.					

**NURSING SCIENCE 108
MEDICAL-SURGICAL NURSING III**

3.00 UNITS

7760	lec	1:00pm - 4:35pm	M	D.A. JENKINSON	TH 100
&	lab	7:00am - 5:05pm	F	D.A. JENKINSON	H OSP
<i>(8 Week Class - Starts 8/30/2010, Ends 10/22/2010)</i>					
7761	lec	1:00pm - 4:35pm	M	D.A. JENKINSON	TL 100
&	lab	7:00am - 5:05pm	T	D.A. JENKINSON	H OSP
<i>(8 Week Class - Starts 8/30/2010, Ends 10/22/2010)</i>					

**NURSING SCIENCE 109
GERONTOLOGY & COMMUNITY BASED NURSING**

2.00 UNITS

7770	lec	11:00am - 1:20pm	T	R.M. MIDDLETON	TL 100
&	lab	7:00am - 1:35pm	Th	R.M. MIDDLETON	COUN VILL
<i>(8 Week Class - Starts 8/30/2010, Ends 10/22/2010)</i>					
• Country Villa East, 2415 South Western Avenue, Los Angeles, CA 90018.					
7771	lec	9:00am - 11:20am	T	R.M. MIDDLETON	TB 100
&	lab	7:00am - 1:35pm	F	C.M. ASHBY	COUN VILL
<i>(8 Week Class - Starts 8/30/2010, Ends 10/22/2010)</i>					
• Country Villa East, 2415 South Western Avenue, Los Angeles, CA 90018.					
7772	lec	9:00am - 11:20am	T	R.M. MIDDLETON	TB 100
&	lab	7:00am - 3:50pm	Th	R.M. MIDDLETON	COUN VILL
<i>(6 Week Class - Starts 10/25/2010, Ends 12/17/2010)</i>					
• Country Villa East, 2415 South Western Avenue, Los Angeles, CA 90018.					
7773	lec	11:00am - 1:20pm	T	R.M. MIDDLETON	TB 100
&	lab	7:00am - 2:25pm	F	C.M. ASHBY	COUN VILL
<i>(7 Week Class - Starts 10/25/2010, Ends 12/17/2010)</i>					
• Country Villa East, 2415 South Western Avenue, Los Angeles, CA 90018.					

**NURSING SCIENCE 110
PSYCHIATRIC-MENTAL HEALTH NURSING**

3.00 UNITS

7755	lec	1:00pm - 4:20pm	M	STAFF	TB 100
&	lab	7:00am - 5:05pm	Th	STAFF	CEDA SINA
<i>(8 Week Class - Starts 8/30/2010, Ends 10/22/2010)</i>					
• Cedars Sinai Medical Center, 8700 Beverly Blvd., Los Angeles, CA 90048.					
7756	lec	1:00pm - 4:20pm	M	STAFF	TB 100
&	lab	7:00am - 5:05pm	F	STAFF	CEDA SINA
<i>(8 Week Class - Starts 8/30/2010, Ends 10/22/2010)</i>					
• Cedars Sinai Medical Center, 8700 Beverly Blvd., Los Angeles, CA 90048.					

7757	lec	1:00pm - 4:20pm	M	STAFF	TB 100
&	lab	7:00am - 5:05pm	Th	T.V. CREEKMUR	CEDA SINA
<i>(7 Week Class - Starts 10/25/2010, Ends 12/17/2010)</i>					
• Cedars Sinai Medical Center, 8700 Beverly Blvd., Los Angeles, CA 90048.					
7758	lec	1:00pm - 4:20pm	M	STAFF	TB 100
&	lab	7:00am - 5:05pm	F	STAFF	CEDA SINA
<i>(7 Week Class - Starts 10/25/2010, Ends 12/17/2010)</i>					
• Cedars Sinai Medical Center, 8700 Beverly Blvd., Los Angeles, CA 90048.					

**NURSING SCIENCE 111
REPRODUCTIVE NURSING AND WOMENS HEALTH (CSU)**

3.50 UNITS

7745	lec	9:00am - 2:05pm	T	C.C. CHANDLER	TH 100
&	lab	7:00am - 4:05pm	M	C.C. CHANDLER	CA HOSP
<i>(7 Week Class - Starts 8/30/2010, Ends 10/22/2010)</i>					
• California Hospital, 1401 South Grand Ave., Los Angeles, CA 90015.					
7746	lec	9:00am - 2:05pm	T	C.C. CHANDLER	TH 100
&	lab	7:00am - 5:50pm	Th	C.C. CHANDLER	HOLL PRES
<i>(8 Week Class - Starts 8/30/2010, Ends 10/22/2010)</i>					
• Hollywood Presbyterian Medical Center, 1300 North Vermont Ave., Los Angeles, CA 90027. 213-413-3000					
7747	lec	9:00am - 2:05pm	T	C.C. CHANDLER	TH 100
&	lab	7:00am - 4:05pm	M	C.C. CHANDLER	HOLL PRES
<i>(8 Week Class - Starts 10/25/2010, Ends 12/17/2010)</i>					
• Hollywood Presbyterian Medical Center, 1300 North Vermont Ave., Los Angeles, CA 90027. 213-413-3000					
7748	lec	9:00am - 2:05pm	T	C.C. CHANDLER	TH 100
&	lab	7:00am - 4:05pm	Th	C.C. CHANDLER	HOLL PRES
<i>(6 Week Class - Starts 10/25/2010, Ends 12/17/2010)</i>					
• Hollywood Presbyterian Medical Center, 1300 North Vermont Ave., Los Angeles, CA 90027. 213-413-3000					

**NURSING SCIENCE 112
CARE OF CHILDREN AND FAMILY**

3.50 UNITS

7751	lec	9:00am - 2:05pm	Th	J.H. REILEY	TH 100
&	lab	7:00am - 5:50pm	M	J.H. REILEY	H OSP
<i>(7 Week Class - Starts 8/30/2010, Ends 10/22/2010)</i>					
7752	lec	9:00am - 2:05pm	Th	J.H. REILEY	TH 100
&	lab	7:00am - 6:10pm	M	J.H. REILEY	H OSP
<i>(7 Week Class - Starts 8/30/2010, Ends 10/22/2010)</i>					
7753	lec	9:00am - 2:05pm	Th	J.H. REILEY	TH 100
&	lab	7:00am - 6:10pm	SU	J.H. REILEY	H OSP
<i>(8 Week Class - Starts 8/30/2010, Ends 10/22/2010)</i>					

**NURSING SCIENCE 114
NURSING LEADERSHIP & MANAGEMENT**

3.00 UNITS

7775	lec	9:00am - 12:00pm	W	D.A. JENKINSON	TL 100
&	lab	16:35 hrs/wk TBA	-	D.A. JENKINSON	H OSP
<i>(8 Week Class - Starts 10/25/2010, Ends 12/17/2010)</i>					
7776	lec	9:00am - 12:05pm	W	D.A. JENKINSON	TL 100
&	lab	16:35 hrs/wk TBA	-	R.M. MIDDLETON	H OSP
<i>(8 Week Class - Starts 10/25/2010, Ends 12/17/2010)</i>					
7777	lec	9:00am - 12:05pm	W	D.A. JENKINSON	TL 100
&	lab	16:35 hrs/wk TBA	-	J.H. REILEY	H OSP
<i>(8 Week Class - Starts 10/25/2010, Ends 12/17/2010)</i>					

**NURSING SCIENCE 115
BASIC SKILLS ENHANCEMENT LAB (CSU)**

1.00 UNIT

7798	lab	1:00 hrs/wk TBA	-	L.V. JACOBS	TK 100
------	-----	-----------------	---	-------------	--------

**NURSING SCIENCE 116
SKILLS ENHANCEMENT LABORATORY (CSU)**

2.00 UNITS

7800	lab	2:05 hrs/wk TBA	-	R.M. MIDDLETON	TK 100
------	-----	-----------------	---	----------------	--------

OCEANOGRAPHY

Oceanography 1 is offered through Instructional Television (ITV) Program. For registration and orientation, see Ad on page 87

OFFICE MACHINES

OFFICE MACHINES 002				1.00 UNIT
ADDING AND CALCULATING MACHINES				
Evening Class				
3048	lab	6:00pm - 8:05pm	T	V.M. EMERSON K 324

PARALEGAL

PARALEGAL 010				3.00 UNITS
INTRODUCTION TO LAW AND LEGAL PROFESSION (CSU)				
0198	lec	11:45am - 1:10pm	MW	K.L. GARY K 324

PARALEGAL 012				3.00 UNITS
TORT LAW				
0179	lec	10:10am - 11:35am	MW	K.L. GARY K 324

PARALEGAL 017				3.00 UNITS
LEGAL WRITING				
0180	lec	10:10am - 11:35am	TTh	K.L. GARY K 324

PARALEGAL 019				3.00 UNITS
PROPERTY AND CREDITOR RIGHTS				
0181	lec	1:20pm - 2:40pm	TTh	K.L. GARY K 324

PERSONAL DEVELOPMENT

PERSONAL DEVELOPMENT 002				1.00 UNIT
INTERPERSONAL RELATIONSHIPS (CSU)				
1101	lec	11:00am - 12:05pm	W	L.E. COLE ST 401
9581	lec	2:00pm - 3:05pm	W	G.M. ROSARIO F 231
9583	lec	1:30pm - 2:35pm	M	L.M. BRENT F 231
&	lec	1:25 hrs/wk TBA	-	L.M. BRENT F 231
<i>(6 Week Class - Starts 9/13/2010, Ends 10/18/2010)</i>				
9584	lec	1:30pm - 2:30pm	M	L.M. BRENT TE 208
&	lec	2:15 hrs/wk TBA	-	L.M. BRENT TE 208
<i>(6 Week Class - Starts 10/25/2010, Ends 11/29/2010)</i>				
9586	lec	11:45am - 12:50pm	T	A. HOSSEINI F 222

PERSONAL DEVELOPMENT 004				1.00 UNIT
CAREER PLANNING (CSU)				
9582	lec	1:00pm - 2:05pm	Th	K.D. SKINNER K 322
9587	lec	8:30am - 11:40am	T	K.D. SKINNER K 322
9588	lec	8:30am - 11:40am	W	M.L. BURNETT F 231

PHILOSOPHY

PHILOSOPHY 001				3.00 UNITS
INTRODUCTION TO PHILOSOPHY (UC:CSU)				
1344	lec	10:10am - 11:35am	TTh	V.G. SHIRIKJIAN F 227
1570	lec	8:35am - 10:00am	MW	M.E. SARGENT F 227
1571	lec	10:10am - 11:35am	MW	M.E. SARGENT F 227
1573	lec	8:35am - 10:00am	TTh	V.G. SHIRIKJIAN F 227
Evening Class				
3945	lec	6:00pm - 9:10pm	Th	R.J. EGAN F 227

Philosophy 1 is also offered through Instructional Television (ITV) Program. For registration and orientation, see Ad on page 87

PHILOSOPHY 008				3.00 UNITS
DEDUCTIVE LOGIC (UC:CSU)				
1574	lec	11:45am - 1:10pm	TTh	V.G. SHIRIKJIAN F 227
1577	lec	11:45am - 1:10pm	MW	V.G. SHIRIKJIAN TBA
Evening Class				
3946	lec	6:00pm - 9:10pm	T	R.J. EGAN F 227

PHYSICAL EDUCATION

PHYSICAL EDUCATION 101				1.00 UNIT
SWIMMING-NON/SWIMMER (UC:CSU)				
2701	lab	10:10am - 11:35am	MW	J.E. RATCLIFF P OOL
2703	lab	11:45am - 1:10pm	MW	J.E. RATCLIFF P OOL
2705	lab	10:10am - 11:35am	TTh	J.E. RATCLIFF P OOL
2707	lab	11:45am - 1:10pm	TTh	J.E. RATCLIFF P OOL

PHYSICAL EDUCATION 102				1.00 UNIT
SWIMMING SKILLS (UC:CSU)				
2702	lab	10:10am - 11:35am	MW	J.E. RATCLIFF P OOL
2704	lab	11:45am - 1:10pm	MW	J.E. RATCLIFF P OOL
2708	lab	11:45am - 1:10pm	TTh	J.E. RATCLIFF P OOL
2709	lab	10:10am - 11:35am	TTh	J.E. RATCLIFF P OOL
2710	lab	9:00am - 12:05pm	S	M.D. MAYFIELD P OOL

PHYSICAL EDUCATION 131				1.00 UNIT
AQUA AEROBICS (UC:CSU)				
2715	lab	1:20pm - 2:45pm	TTh	L.D. DELZEIT P OOL

**PHYSICAL EDUCATION 170
WALKING FOR FITNESS (UC:CSU) 1.00 UNIT**

2170 lab 10:10am - 11:35am TTh S.L. SULLIVAN J 212

**PHYSICAL EDUCATION 462
MODERN DANCE (UC:CSU) 1.00 UNIT**

2120 lab 11:45am - 1:10pm MW D. DE FRANCO BROWNE J 212

2121 lab 11:45am - 1:10pm TTh D. DE FRANCO BROWNE J 212

**PHYSICAL EDUCATION 465
AEROBICS FOR DANCE (UC:CSU) 1.00 UNIT**

2229 lab 10:10am - 11:35am MW D. DE FRANCO BROWNE G 100

**PHYSICAL EDUCATION 500
BASKETBALL THEORY (UC:CSU) 3.00 UNITS**

2718 lec 10:10am - 11:25am MW R.L. WELLS F 216

& lab 11:45am - 12:30pm MW R.L. WELLS G 100

2719 lec 4:00pm - 5:05pm MTWTh K. BLY F 216

& lab 9:00am - 12:10pm S K. BLY G 100

**PHYSICAL EDUCATION 504
INTERCOLLEGIATE SPORTS - BASKETBALL (UC:CSU) 3.00 UNITS**

2906 lab 11:05 hrs/wk TBA - R.L. WELLS G 100

2912 lab 11:05 hrs/wk TBA - K. BLY G 100

**PHYSICAL EDUCATION 506
INTERCOLLEGIATE SPORTS - CROSS COUNTRY (UC:CSU) 3.00 UNITS**

2513 lab 11:05 hrs/wk TBA - M.A. WAGENBACH J FLD

**PHYSICAL EDUCATION 516
INTERCOLLEGIATE SPORTS - VOLLEYBALL (UC:CSU) 3.00 UNITS**

2516 lab 11:05 hrs/wk TBA - C.C. CHAU G 100

**PHYSICAL EDUCATION 517
INTERCOLLEGIATE SPORTS - WATER POLO (UC:CSU) 3.00 UNITS**

2511 lab 11:05 hrs/wk TBA - S. LUEDECKE P OOL

**PHYSICAL EDUCATION 552
ATHLETICS PRE-SEASON CONDITIONING (UC:CSU) 1.00 UNIT**

2600 lab 6:00am - 7:30am MW M. VAN NORMAN P OOL

2601 lab 6:00pm - 9:10pm S C.C. CHAU G 100

**PHYSICAL EDUCATION 628
SWIM AND RUN FOR FITNESS (UC:CSU) 1.00 UNIT**

2706 lab 8:35am - 10:00am TTh M.A. WAGENBACH P OOL

**PHYSICAL EDUCATION 666
BODY CONDITIONING (UC:CSU) 1.00 UNIT**

2201 lab 7:00am - 8:25am MW J.E. BUDINGER LRC BASE

2202 lab 8:35am - 10:10am MW J.E. BUDINGER LRC BASE

2203 lab 10:10am - 11:35am MW J.G. BROWNE LRC BASE

2204 lab 11:45am - 1:10pm MW J.E. BUDINGER LRC BASE

2205 lab 1:20pm - 2:45pm MW J.E. BUDINGER LRC BASE

2215 lab 3:00pm - 4:25pm MW G.T. SKARR LRC BASE

2216 lab 4:30pm - 5:55pm MW D.R. LAGOS LRC BASE

2901 lab 6:00pm - 7:25pm MW STAFF LRC BASE

**PHYSICAL EDUCATION 690
WEIGHT TRAINING (UC:CSU) 1.00 UNIT**

2206 lab 7:00am - 8:30am TTh J.E. BUDINGER LRC BASE

2207 lab 8:35am - 10:00am TTh J.E. BUDINGER LRC BASE

2208 lab 10:10am - 11:35am TTh J.G. BROWNE LRC BASE

2209 lab 11:45am - 1:10pm TTh J.E. BUDINGER LRC BASE

2210 lab 1:20pm - 2:45pm TTh C.L. SWATEK LRC BASE

2211 lab 9:00am - 12:05pm F S. LUEDECKE LRC BASE

2213 lab 9:00am - 12:10pm S B.C. PFIFFNER LRC BASE

2217 lab 6:00pm - 7:25pm TTh S.E. SECK LRC BASE

**PHYSICAL EDUCATION 742
CARDIO KICKBOXING (UC:CSU) 1.00 UNIT**

2603 lab 10:10am - 11:35am TTh J.E. BUDINGER G 100

**PHYSICAL EDUCATION (NON-ACTIVITY) 750
SPORTS ETHICS (CSU) 3.00 UNITS**

7915 lec 3:10 hrs/wk TBA - J.G. BROWNE ON LINE

- Please visit the online program homepage at <http://moodle.latic.edu> prior to the start of class for directions, or see pages 82-84 of this schedule for more information.

**PHYSICAL EDUCATION (NON-ACTIVITY) 762
ANCIENT OLYMPIC GAMES 3.00 UNITS**

7907 lec 3:10 hrs/wk TBA - J.G. BROWNE ON LINE

- Please visit the online program homepage at <http://moodle.latic.edu> prior to the start of class for directions, or see pages 82-84 of this schedule for more information.

**PHYSICAL EDUCATION 800
INTRODUCTION TO DANCE AND DANCE HISTORY (UC:CSU) 3.00 UNITS**

2119 lec 10:10am - 11:35am TTh D. DE FRANCO BROWNE F 215

**PHYSICAL EDUCATION (NON-ACTIVITY) 814
DANCE PRODUCTION I (UC:CSU) 2.00 UNITS**

2721 lab 2:00 hrs/wk TBA - D. DE FRANCO BROWNE J 212

& lec 1:00 hrs/wk TBA - D. DE FRANCO BROWNE J 212

PHYSICS**PHYSICS 001
MECHANICS OF SOLIDS (UC:CSU) 4.00 UNITS**

Prerequisite: Physics 11 or equivalent and prerequisite or corequisite: Math 265.

1740 lec 10:10am - 12:00pm T R.J. POWERS K 420

& lec 10:10am - 11:15am Th R.J. POWERS K 420

& lab 11:40am - 2:50pm Th R.J. POWERS K 420

**PHYSICS 003
ELECTRICITY AND MAGNETISM (UC:CSU) 4.00 UNITS**

Prerequisite: Physics 001 & prerequisite or corequisite Math 266 with a grade of 'C' or better.

1741 lec 1:00pm - 4:10pm Th M.A. MORENO K 422

& lab 9:50am - 1:00pm F M.A. MORENO K 420

PHYSICS 006
GENERAL PHYSICS I (UC:CSU)

4.00 UNITS

Prerequisite: Physics 11 & Math 240 with a grade of 'C' or better.

1742	lec	6:30pm - 9:40pm	M	M.A. MORENO	USC EART
&	lab	1:00pm - 4:10pm	F	M.A. MORENO	K 420

• USC University Park Campus, Earth Science Building, B-56 (213) 740-2311

PHYSICS 011
INTRODUCTORY PHYSICS (UC:CSU)

4.00 UNITS

Prerequisite or corequisite Math 114 or 115 with a grade of 'C' or better.

1745	lec	8:35am - 10:00am	MW	F.J. PADILLA	K 422
&	lab	7:00am - 10:10am	Th	F.J. PADILLA	K 422
1748	lec	8:35am - 11:45am	M	M.A. EL TAWANSY	K 420
&	lab	8:35am - 11:45am	W	M.A. EL TAWANSY	K 420
1756	lec	7:00am - 10:10am	F	F.J. PADILLA	K 406
&	lab	10:20am - 1:30pm	F	F.J. PADILLA	K 422

Evening Class

4090	lec	6:00pm - 9:10pm	T	T.M. GOODMAN	K 321
&	lab	6:00pm - 9:10pm	Th	T.M. GOODMAN	K 422

PHYSICS 012
PHYSICS FUNDAMENTALS (UC:CSU)

3.00 UNITS

Prerequisite: Math 114 or 115 with a grade of 'C' or better.

1746	lec	8:35am - 11:45am	M	M.A. EL TAWANSY	K 420
1757	lec	7:00am - 10:10am	F	F.J. PADILLA	K 406

Evening Classes

4091	lec	6:00pm - 9:10pm	T	T.M. GOODMAN	K 321
------	-----	-----------------	---	--------------	-------

PHYSICS 014
PHYSICS FUNDAMENTALS LABORATORY (UC:CSU)

1.00 UNIT

Recommended Preparation: Physics 12 with a grade of 'C' or better.

1747	lab	7:00am - 10:10am	Th	F.J. PADILLA	K 422
1758	lab	10:20am - 1:30pm	F	F.J. PADILLA	K 422

PHYSICS 185
DIRECTED STUDY - PHYSICS (CSU)

1.00 UNIT

1796	lec	1:00 hrs/wk TBA	-	F.J. PADILLA	K 405
------	-----	-----------------	---	--------------	-------

PHYSICS 285
DIRECTED STUDY - PHYSICS (CSU)

2.00 UNITS

1800	lec	2:35 hrs/wk TBA	-	M.A. MORENO	TBA
------	-----	-----------------	---	-------------	-----

PLUMBING

PLUMBING 026
PLUMBING LAYOUT AND ESTIMATING I

3.00 UNITS

Evening Classes

4746	lec	6:00pm - 9:10pm	M	T.E. SWEIGART	B 200B
------	-----	-----------------	---	---------------	--------

PLUMBING 028
PLUMBING CODE I

3.00 UNITS

Plumbing mathematics and elementary drawings.

Evening Classes

4739	lec	6:00pm - 9:10pm	T	L. JONES	B 222
------	-----	-----------------	---	----------	-------

PLUMBING 029
PLUMBING CODE II

3.00 UNITS

Evening Classes

4740	lec	6:00pm - 9:10pm	Th	L. JONES	B 222
------	-----	-----------------	----	----------	-------

PLUMBING 031
BACKFLOW PREVENTION DEVICES

3.00 UNITS

Evening Classes

4744	lec	6:00pm - 6:40pm	TTh	K.S. FREIDENBERGER	B 200B
&	lab	6:40pm - 9:10pm	TTh	K.S. FREIDENBERGER	B 200

PLUMBING 111
INTRODUCTION TO PLUMBING

3.00 UNITS

8163	lec	7:00am - 7:30am	TTh	T.W. SLADE	B 352
&	lab	9:15am - 12:25pm	TTh	T.W. SLADE	B 252

PLUMBING 112
FUNDAMENTALS OF PLUMBING

3.00 UNITS

8164	lec	7:40am - 9:05am	TTh	T.W. SLADE	B 352
------	-----	-----------------	-----	------------	-------

Evening Classes

4745	lec	6:00pm - 9:10pm	M	R.W. YATES	B 250
------	-----	-----------------	---	------------	-------

PLUMBING 113
BASIC PLUMBING PRINCIPLES AND PRACTICES

6.00 UNITS

8165	lec	7:00am - 8:05am	MWF	T.W. SLADE	B 352
&	lab	8:05am - 11:05am	MWF	T.W. SLADE	B 252

PLUMBING 121
WORKING DRAWINGS AND LAYOUT I

3.00 UNITS

8166	lec	7:00am - 8:25am	MW	L. JONES	B 222
------	-----	-----------------	----	----------	-------

PLUMBING 122
PLUMBING MATHEMATICS AND PROCEDURES II

3.00 UNITS

8167	lec	7:00am - 8:25am	TTh	L. JONES	B 222
------	-----	-----------------	-----	----------	-------

PLUMBING 123
PLUMBING PRACTICES AND INSTALLATION

6.00 UNITS

8168	lec	8:35am - 9:20am	MW	L. JONES	B 222
&	lab	8:35am - 11:40am	TTh	L. JONES	B 200
&	lab	7:00am - 10:35am	F	L. JONES	B 200
&	lab	9:20am - 11:40am	MW	L. JONES	B 200

PLUMBING 131
WORKING DRAWING II

3.00 UNITS

8169	lec	7:00am - 8:25am	TTh	C.R. DEAN	B 200B
------	-----	-----------------	-----	-----------	--------

PLUMBING 132
PLUMBING MATHEMATICS AND PROCEDURES II

3.00 UNITS

8170	lec	8:25am - 8:55am	TTh	C.R. DEAN	B 200
&	lab	8:55am - 12:05pm	TTh	C.R. DEAN	B 200

PLUMBING 133
INSTALLATION AND PLUMBING FIXTURES

6.00 UNITS

8171	lec	7:00am - 8:05am	MWF	W.M. GALVAN	B 200B
&	lab	8:05am - 11:05am	MWF	W.M. GALVAN	B 200

PLUMBING 941
COOPERATIVE EDUCATION - PLUMBING

4.00 UNITS

See page 85 for detail and meeting times

9160	lec	4:25 hrs/wk TBA	-	C.L. ANDERSON	D 236
------	-----	-----------------	---	---------------	-------

POLITICAL SCIENCE

POLITICAL SCIENCE 001 THE GOVERNMENT OF THE UNITED STATES (UC:CSU) 3.00 UNITS

1030	lec	8:35am - 10:00am	MW	S. SANCHEZ	TE 401
1031	lec	10:10am - 11:35am	MW	D. ROMERO	TE 401
1032	lec	11:45am - 1:10pm	MW	G.J. PENN	TE 401
1033	lec	8:35am - 10:00am	TTh	S. SANCHEZ	TE 401
1034	lec	10:10am - 11:35am	TTh	B.D. VADEN	TE 401
7972	lec	3:10 hrs/wk TBA	-	J.P. TABAKIAN	ON LINE

- Please visit the online program homepage at <http://moodle.lattc.edu> prior to the start of class for directions, or see pages 82-84 of this schedule for more information.

Evening Classes

3630	lec	6:00pm - 9:10pm	M	E. GONZALEZ	TE 401
3632	lec	6:00pm - 9:10pm	Th	L.B. COULTER	TE 401

Political Science 1 is also offered through Instructional Television (ITV) Program. For registration and orientation, see Ad on page 87

POLITICAL SCIENCE 002 MODERN WORLD GOVERNMENTS (UC:CSU) 3.00 UNITS

1036	lec	10:10am - 11:35am	TTh	J.P. TABAKIAN	TE 310
------	-----	-------------------	-----	---------------	--------

PROCESS PLANT TECHNOLOGY

PROCESS PLANT TECHNOLOGY 100 INTRODUCTION TO INDUSTRIAL PROCESS 3.00 UNITS

1646	lec	10:15am - 11:25am	Th	C. SUTTON	K 424
&	lec	11:05am - 1:00pm	F	C. SUTTON	K 424
Evening Class					
4085	lec	6:00pm - 9:10pm	W	S.I. OKEKE	K 424

PROCESS PLANT TECHNOLOGY 103 PROCESS PLANT EQUIPMENT 3.00 UNITS

1647	lec	6:30am - 8:25am	W	J. CHAPMAN	K 424
&	lab	10:20am - 1:25pm	W	J. CHAPMAN	B 120
Evening Class					
4086	lec	6:00pm - 8:00pm	Th	S.I. OKEKE	K 424
&	lab	8:00pm - 10:00pm	Th	S.I. OKEKE	B 120
&	lab	1:05 hrs/wk TBA	-	S.I. OKEKE	B 102

PROCESS PLANT TECHNOLOGY 104 INTRODUCTION TO PROCESS PLANT SAFETY 3.00 UNITS

1644	lec	6:30am - 8:30am	M	R.M. MADYUN	K 424
&	lec	1:05 hrs/wk TBA	-	R.M. MADYUN	K 424

PROCESS PLANT TECHNOLOGY 206 PTEC-ADVANCED INSTRUMENTATION II 3.00 UNITS

1642	lec	8:35am - 11:40am	M	STAFF	K 424
Evening Class					
4082	lec	6:00pm - 9:10pm	M	STAFF	K 424

PROCESS PLANT TECHNOLOGY 210 APPLIED INSTRUMENTATION ANALYSIS - I 4.00 UNITS

1643	lec	7:00am - 9:00am	T	STAFF	K 424
&	lab	9:00am - 11:00am	T	STAFF	K 424
Evening Class					
4084	lec	6:00pm - 8:00pm	T	STAFF	K 424
&	lab	8:00pm - 10:00pm	T	STAFF	K 424

PSYCHOLOGY

PSYCHOLOGY 001 GENERAL PSYCHOLOGY I (UC:CSU) 3.00 UNITS

1040	lec	8:35am - 10:00am	MW	M.D. WALLACH	TE 312
1041	lec	10:10am - 11:35am	MW	L.S. KORITZKE	TE 312
1043	lec	8:35am - 10:00am	TTh	R.W. ESSEX	TE 201
1044	lec	10:10am - 11:35am	TTh	R.W. ESSEX	TE 201
1045	lec	11:45am - 1:10pm	TTh	R.W. ESSEX	TE 201
7975	lec	3:10 hrs/wk TBA	-	L.S. KORITZKE	ON LINE

- Please visit the online program homepage at <http://moodle.lattc.edu> prior to the start of class for directions, or see pages 82-84 of this schedule for more information.

Evening Class

3640	lec	6:00pm - 9:10pm	M	R.W. ESSEX	TE 201
3641	lec	6:00pm - 9:10pm	Th	E. MILLER	TE 213

Psychology 1 is also offered through Instructional Television (ITV) Program. For registration and orientation, see Ad on page 87

PSYCHOLOGY 002 GENERAL PSYCHOLOGY II (UC:CSU) 3.00 UNITS

Evening Class					
3642	lec	6:00pm - 9:10pm	W	R.W. ESSEX	TE 213

PSYCHOLOGY 041 LIFE-SPAN PSYCHOLOGY: FROM INFANCY TO OLD AGE (UC:CSU) 3.00 UNITS

Prerequisite: Psychology 1.

1046	lec	8:35am - 10:00am	MW	A.E. BEVACQUA	TE 201
1047	lec	10:10am - 11:35am	TTh	M.J. BENTLEY	TE 312
1048	lec	11:45am - 1:10pm	MW	L.S. KORITZKE	TE 312
7981	lec	3:10 hrs/wk TBA	-	L.S. KORITZKE	ON LINE

- Please visit the online program homepage at <http://moodle.lattc.edu> prior to the start of class for directions, or see pages 82-84 of this schedule for more information.

Evening Class

3650	lec	6:00pm - 9:10pm	T	R.W. ESSEX	K 258
------	-----	-----------------	---	------------	-------

Psychology 41 is also offered through Instructional Television (ITV) Program. For registration and orientation, see Ad on page 87

PSYCHOLOGY 069 PSYCHOLOGY IN FILM (CSU) 3.00 UNITS

Prerequisite: Psychology 1

7983	lec	3:10 hrs/wk TBA	-	L.S. KORITZKE	ON LINE
------	-----	-----------------	---	---------------	---------

- Please visit the online program homepage at <http://moodle.lattc.edu> prior to the start of class for directions, or see pages 82-84 of this schedule for more information.

PUBLIC RELATIONS

PUBLIC RELATIONS 002	3.00 UNITS
PUBLIC RELATIONS TECHNIQUES (CSU)	
0197 lec 11:45am - 1:10pm TTh M.C. BESSLER	K 262

REAL ESTATE

REAL ESTATE 001	3.00 UNITS
REAL ESTATE PRINCIPLES (CSU)	
8360 lec 1:00pm - 4:10pm M M.D. TAYLOR	K 322
Evening Class	
4954 lec 6:00pm - 9:15pm M M.D. TAYLOR	K 322

REAL ESTATE 003	3.00 UNITS
REAL ESTATE PRACTICES (CSU)	
3068 lec 1:00pm - 4:10pm T M.D. TAYLOR	K 322
Evening Class	
4955 lec 6:00pm - 9:15pm T M.D. TAYLOR	K 322

REAL ESTATE 007	3.00 UNITS
REAL ESTATE FINANCE I (CSU)	
Evening Class	
4956 lec 6:00pm - 9:15pm Th M.D. TAYLOR	K 322

REFRIGERATION & AIR CONDITIONING MECHANICS

REFRIGERATION & AIR CONDITIONING MECHANICS 100	3.00 UNITS
AIR CONDITIONING PROJECT MANAGEMENT	
Evening Class	
4841 lec 6:00pm - 9:10pm Th STAFF	B 232

REFRIGERATION & AIR CONDITIONING MECHANICS 111	3.00 UNITS
FUNDAMENTALS OF REFRIGERATION	
8300 lec 7:00am - 10:10am M G. CIOFFI	B 250

ATTENTION STUDENTS: ENROLL EARLY!!

For more information on how to enroll in your classes or to have other Student Services questions answered or about our "NEW" Queuing System located in the Student Services (ST) Building – First Floor, please refer to page 99.

REFRIGERATION & AIR CONDITIONING MECHANICS 113	3.00 UNITS
REFRIGERATION COMPONENT CONSTRUCTION	
8301 lab 7:00am - 12:05pm TTh G. CIOFFI	B 238

REFRIGERATION & AIR CONDITIONING MECHANICS 114	3.00 UNITS
REFRIGERATION MAINTENANCE PROCEDURES	
8302 lab 7:00am - 12:05pm WF G. CIOFFI	B 238

REFRIGERATION & AIR CONDITIONING MECHANICS 123	3.00 UNITS
PIPE AND TUBE JOINING PROCESSES	
8304 lab 7:00am - 12:05pm MW C.J. BARNETT	B 237

REFRIGERATION & AIR CONDITIONING MECHANICS 124	3.00 UNITS
REFRIGERATION ELECTRICAL CIRCUITS AND CONTROLS	
8305 lab 7:00am - 12:05pm TTh C.J. BARNETT	B 237

REFRIGERATION & AIR CONDITIONING MECHANICS 125	3.00 UNITS
REFRIGERATION SYSTEM COMPONENTS	
8306 lec 7:00am - 10:10am F C.J. BARNETT	B 233

REFRIGERATION & AIR CONDITIONING MECHANICS 133	3.00 UNITS
REFRIGERATION SERVICE PROCEDURES I	
8308 lab 7:00am - 12:05pm MW M.R. NEEDHAM	B 232

REFRIGERATION & AIR CONDITIONING MECHANICS 134	3.00 UNITS
SERVICE FOR AIR CONDITIONING EQUIPMENT I	
8309 lab 7:00am - 12:05pm TTh M.R. NEEDHAM	B 232

REFRIGERATION & AIR CONDITIONING MECHANICS 135	3.00 UNITS
AIR CONDITIONING AND REFRIGERATION	
8310 lec 7:00am - 10:10am F M.R. NEEDHAM	B 221

REFRIGERATION & AIR CONDITIONING MECHANICS 141	3.00 UNITS
APPLIED REFRIGERATION AND AIR CONDITIONING PRINCIPLES	
8311 lec 7:00am - 10:10am F K. DOZIER	B 203

REFRIGERATION & AIR CONDITIONING MECHANICS 143	3.00 UNITS
REFRIGERATION SERVICING PROCEDURES II	
8312 lab 7:00am - 12:05pm MW K. DOZIER	B 204

REFRIGERATION & AIR CONDITIONING MECHANICS 145	3.00 UNITS
AIR CONDITIONING AND REFRIGERATION MECHANICS	
8313 lab 7:00am - 12:05pm TTh K. DOZIER	B 204

REFRIGERATION & AIR CONDITIONING MECHANICS 160	4.00 UNITS
REFRIGERATION SYSTEM PRINCIPLES AND PRACTICES	
Evening Class	
4784 lec 8:00am - 10:30am S M.R. NEEDHAM	B 233
& lab 10:30am - 3:40pm S M.R. NEEDHAM	B 233

REFRIGERATION & AIR CONDITIONING MECHANICS 161	4.00 UNITS
AIR CONDITIONING SYSTEM PRINCIPLES AND PRACTICES	
Evening Class	
4767 lec 6:00pm - 7:10pm MW P.B. KAHNG	B 203
& lab 7:10pm - 9:40pm MW P.B. KAHNG	B 204

REFRIGERATION & AIR CONDITIONING MECHANICS 162 4.00 UNITS
PIPING PRINCIPLES AND PRACTICES**Evening Class**

4774	lec	6:00pm - 7:10pm	TTh	B.R. CORBIN	B 237
&	lab	7:10pm - 9:40pm	TTh	B.R. CORBIN	B 237

REFRIGERATION & AIR CONDITIONING MECHANICS 164 3.00 UNITS
GAS HEATING SYSTEMS (CSU)**Evening Class**

4759	lec	6:00pm - 6:45pm	MW	STAFF	B 232
&	lab	6:45pm - 9:10pm	MW	STAFF	B 221

REFRIGERATION & AIR CONDITIONING MECHANICS 165 4.00 UNITS
THERMAL ENERGY STORAGE/HEAT RECOVERY**Evening Class**

4775	lec	6:00pm - 7:10pm	MW	A.P. DATIS	B 252
&	lab	7:10pm - 9:40pm	MW	A.P. DATIS	B 232

REFRIGERATION & AIR CONDITIONING MECHANICS 188 3.00 UNITS
SERVICING II**Evening Class**

4757	lec	6:00pm - 9:10pm	Th	C.J. BARNETT	B 233
------	-----	-----------------	----	--------------	-------

REFRIGERATION & AIR CONDITIONING MECHANICS 202 3.00 UNITS
REFRIGERATION FUNDAMENTALS (CSU)**Evening Class**

4752	lec	6:00pm - 9:10pm	W	A. ESPINOZA	B 233
------	-----	-----------------	---	-------------	-------

REFRIGERATION & AIR CONDITIONING MECHANICS 203 3.00 UNITS
COMPRESSION SYSTEMS OF REFRIGERATION (CSU)**Evening Class**

4753	lec	6:00pm - 9:10pm	W	P.A. BRADY	B 222
------	-----	-----------------	---	------------	-------

REFRIGERATION & AIR CONDITIONING MECHANICS 204 3.00 UNITS
FUNCTIONS AND COMPRESSION SYSTEM COMPONENTS**Evening Class**

4754	lec	6:00pm - 9:10pm	Th	G.E. ALLEN	B 250
------	-----	-----------------	----	------------	-------

REFRIGERATION & AIR CONDITIONING MECHANICS 208 4.00 UNITS
REFRIGERENT MANAGEMENT - EPA SECTION 608 CERTIFICATION (CSU)

7866	lec	8:05 hrs/wk TBA	-	G. CIOFFI	ON LINE
------	-----	-----------------	---	-----------	---------

- Please visit the online program homepage at <http://moodle.lattc.edu> prior to the start of class for directions, or see pages 82-84 of this schedule for more information.

REFRIGERATION & AIR CONDITIONING MECHANICS 209 4.00 UNITS
NORTH AMERICAN TECHNICIAN EXCELLENCE (NATE) -AIR CONDITIONING SPECIALIST-CERTIFICATION PREPARATION

7867	lec	8:05 hrs/wk TBA	-	G. CIOFFI	ON LINE
------	-----	-----------------	---	-----------	---------

- Please visit the online program homepage at <http://moodle.lattc.edu> prior to the start of class for directions, or see pages 82-84 of this schedule for more information.

REFRIGERATION & AIR CONDITIONING MECHANICS 250 3.00 UNITS
INDOOR AIR QUALITY**Evening Class**

4763	lec	6:00pm - 9:10pm	T	C.J. BARNETT	B 233
------	-----	-----------------	---	--------------	-------

RESTAURANT MANAGEMENT**RESTAURANT MANAGEMENT 100 3.00 UNITS****RESTAURANT MANAGEMENT ORIENTATION (CSU)**

7522	lec	1:40pm - 4:40pm	T	STAFF	E 306
------	-----	-----------------	---	-------	-------

SIGN GRAPHICS**SIGN GRAPHICS 101 10.00 UNITS**
INDIVIDUAL LETTERING

7215	lec	7:00am - 8:00am	TWThF	R.T. GUTHRIE	H 204
&	lab	8:00am - 12:40pm	TWThF	R.T. GUTHRIE	H 204

SIGN GRAPHICS 102 10.00 UNITS
EXTERIOR DISPLAY SIGNS

Prerequisite: SGNNGRPH 101.

7216	lec	7:00am - 8:00am	TWThF	R.T. GUTHRIE	H 204
&	lab	8:00am - 12:40pm	TWThF	R.T. GUTHRIE	H 204

SIGN GRAPHICS 103 10.00 UNITS
WINDOW SIGNS

Prerequisite: SGNNGRPH 102.

7217	lec	7:00am - 8:00am	TWThF	R.T. GUTHRIE	H 204
&	lab	8:00am - 12:40pm	TWThF	R.T. GUTHRIE	H 204

SIGN GRAPHICS 104 10.00 UNITS
ADVANCE COMPUTER & DESIGN

Prerequisite: SGNNGRPH 103.

7218	lec	7:00am - 8:00am	TWThF	R.T. GUTHRIE	H 204
&	lab	8:00am - 12:40pm	TWThF	R.T. GUTHRIE	H 204

SIGN GRAPHICS 185 1.00 UNIT
DIRECTED STUDY - SIGN GRAPHICS

7219	lec	1:05 hrs/wk TBA	-	R.T. GUTHRIE	H 204
------	-----	-----------------	---	--------------	-------

SIGN GRAPHICS 201 2.00 UNITS
FUNDAMENTALS OF MURAL PAINTING

7225	lab	8:00am - 2:45pm	S	A.M. MORTIMER	H 204
------	-----	-----------------	---	---------------	-------

SIGN GRAPHICS 203 2.00 UNITS
SILK SCREEN PROCESSING I

7222	lec	9:00am - 10:00am	S	B.T. JOHNSON	H 230
&	lab	10:00am - 3:45pm	S	B.T. JOHNSON	H 230

SIGN GRAPHICS 204 2.00 UNITS
SILK SCREEN PROCESSING II

7223	lec	9:00am - 10:00am	S	B.T. JOHNSON	H 230
&	lec	10:00am - 3:45pm	S	B.T. JOHNSON	H 230

**SIGN GRAPHICS 211
AUTOMOTIVE GRAPHICS** **2.00 UNITS**

7226	lec	7:00am - 8:00am	M	R.T. GUTHRIE	H 204
&	lec	8:00am - 10:25am	M	R.T. GUTHRIE	H 204

**SIGN GRAPHICS 285
DIRECTED STUDY - SIGN GRAPHICS** **2.00 UNITS**

7220	lec	2:15 hrs/wk TBA	-	R.T. GUTHRIE	H 204
------	-----	-----------------	---	--------------	-------

**SIGN GRAPHICS 385
DIRECTED STUDY - SIGN GRAPHICS** **3.00 UNITS**

7221	lec	3:10 hrs/wk TBA	-	R.T. GUTHRIE	H 204
------	-----	-----------------	---	--------------	-------

SOCIOLOGY**SOCIOLOGY 001
INTRODUCTION TO SOCIOLOGY (UC:CSU)** **3.00 UNITS**

1061	lec	10:10am - 11:35am	MW	F. MCCLAIN	TE 323
1063	lec	11:45am - 1:10pm	MW	F. MCCLAIN	TE 323
1064	lec	10:10am - 11:35am	TTh	F. MCCLAIN	TE 323
1065	lec	11:45am - 1:10pm	TTh	F. MCCLAIN	TE 323
7875	lec	3:10 hrs/wk TBA	-	J.A. GARCIA	ON LINE

- Please visit the online program homepage at <http://moodle.lattc.edu> prior to the start of class for directions, or see pages 82-84 of this schedule for more information.

Evening Class

3661	lec	6:00pm - 9:10pm	Th	F. MCCLAIN	TE 323
------	-----	-----------------	----	------------	--------

Sociology 1 is also offered through Instructional Television (ITV) Program. For registration and orientation, see Ad on page 87

**SOCIOLOGY 002
AMERICAN SOCIAL PROBLEMS (UC:CSU)** **3.00 UNITS**

1070	lec	8:35am - 10:00am	TTh	F. MCCLAIN	TE 323
------	-----	------------------	-----	------------	--------

**SOCIOLOGY 028
THE FAMILY: A SOCIOLOGICAL APPROACH (UC:CSU)** **3.00 UNITS**

1072	lec	8:35am - 10:00am	MW	F. MCCLAIN	TE 323
------	-----	------------------	----	------------	--------

**SOLID WASTE MANAGEMENT
TECHNOLOGY****SOLID WASTE MANAGEMENT TECHNOLOGY 108
TRANSFER STATIONS AND LANDFILLS** **3.00 UNITS****Evening Class**

4178	lec	6:00pm - 9:10pm	M	P.C. BLOUNT	K 406
------	-----	-----------------	---	-------------	-------

**SOLID WASTE MANAGEMENT TECHNOLOGY 941
COOPERATIVE EDUCATION - SOLID WASTE MANAGEMENT TECHNOLOGY** **4.00 UNITS**

See page 85 for detail and meeting times

9212	lec	4:25 hrs/wk TBA	-	C.L. ANDERSON	D 236
------	-----	-----------------	---	---------------	-------

SPANISH**SPANISH 001
ELEMENTARY SPANISH I (UC:CSU)** **5.00 UNITS**

1530	lec	8:35am - 9:45am	MTWTh	H.C. QUINONES	K 366
1531	lec	10:10am - 11:20am	MTWTh	H.C. QUINONES	K 366
1532	lec	11:45am - 12:55pm	MTWTh	H.C. QUINONES	K 366
1533	lec	9:00am - 2:20pm	S	M. LINARES	K 364

Evening Class

3865	lec	6:45pm - 9:15pm	TTh	R. BUSCAGLIA	K 366
------	-----	-----------------	-----	--------------	-------

**SPANISH 002
ELEMENTARY SPANISH II (UC:CSU)** **5.00 UNITS**

Prerequisite: SPANISH 1.

1536	lec	8:35am - 9:45am	MTWTh	R.M. ROSS	K 364
1537	lec	10:10am - 11:20am	MTWTh	R. PALACIOS OCHOA	K 364

Evening Class

3867	lec	6:45pm - 8:20pm	TTh	R. BUSCAGLIA	K 366
------	-----	-----------------	-----	--------------	-------

**SPANISH 003
INTERMEDIATE SPANISH I (UC:CSU)** **5.00 UNITS**

Prerequisite: SPANISH 2.

3866	lec	6:45pm - 9:15pm	TTh	M.M. DRAKE	K 364
6829	lec	3:45pm - 6:25pm	MW	P. ROLDAN	K 368

**SPANISH 021
FUNDAMENTALS OF SPANISH I (UC:CSU)** **3.00 UNITS****Evening Class**

3868	lec	5:00pm - 6:25pm	MW	R. BUSCAGLIA	K 366
------	-----	-----------------	----	--------------	-------

**SPANISH 022
FUNDAMENTALS OF SPANISH II (UC:CSU)** **3.00 UNITS****Evening Class**

3870	lec	5:00pm - 6:25pm	TTh	R. BUSCAGLIA	K 366
------	-----	-----------------	-----	--------------	-------

**SPANISH 035
SPANISH FOR SPANISH SPEAKERS I (UC:CSU)** **5.00 UNITS****Evening Class**

3869	lec	6:45pm - 9:15pm	MW	R. BUSCAGLIA	K 366
------	-----	-----------------	----	--------------	-------

**Don't Wait,
Get Online!!!**

- Registration
- FAQ's
- Counseling
- Financial Aid
- Grades
- Orientation

www.lattc.edu

Spanish Course Sequence

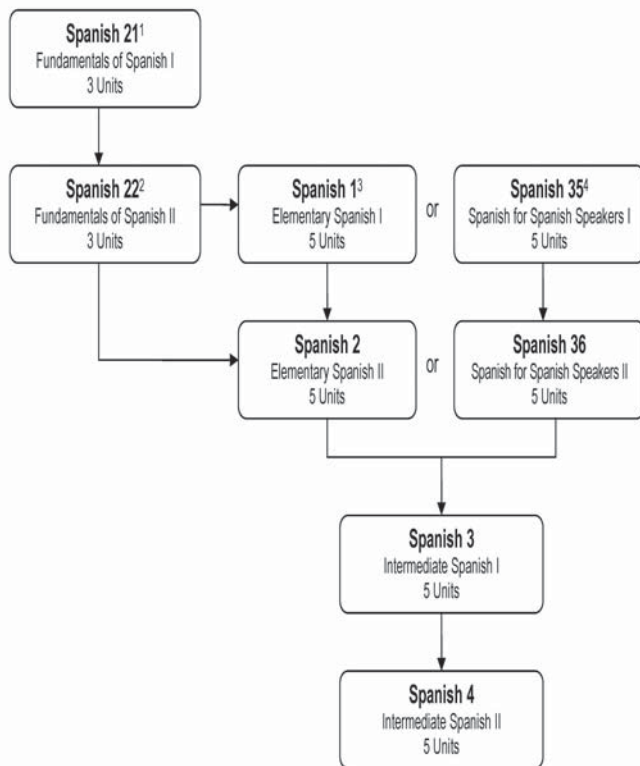

¹ "Spanish 21" can be taken as a first step to acquire the basic to do well in "Spanish 1" or as part of the sequence "Spanish 21 – Spanish 22".

² Completion of the sequence "Spanish 21 – Spanish 22" fulfills the requirement for "Spanish 1". This sequence is recommended for students who do not have the time to embark in a 5 unit class all at once.

³ "Spanish 1" and "Spanish 2" are recommended for non-native speakers.

⁴ "Spanish 35" and "Spanish 36" are recommended for heritage-language speakers (also known as native-speakers or bilingual speakers.)

SPEECH

SPEECH 101 ORAL COMMUNICATION I (UC:CSU) 3.00 UNITS

1502	lec	7:00am - 8:25am	TTh	D.A. WOOD	TE 206
1505	lec	8:35am - 10:00am	MW	J.J. GLAVAN	TE 201
1506	lec	10:10am - 11:35am	MW	J.J. GLAVAN	TE 201
1507	lec	11:45am - 1:10pm	MW	J.J. GLAVAN	TE 201
1509	lec	10:10am - 11:35am	TTh	J.J. GLAVAN	TE 201
1516	lec	8:35am - 10:00am	TTh	J.J. GLAVAN	TE 201
1517	lec	10:10am - 11:35am	TTh	D.A. WOOD	TE 206
1518	lec	7:00am - 8:25am	MW	D.A. WOOD	TE 206
1519	lec	9:00am - 12:10pm	S	A.C. BORNE	TE 201
1521	lec	11:45am - 1:10pm	TTh	D.A. WOOD	TE 206

Evening Classes

3901	lec	6:00pm - 9:20pm	MW	C.V. MCNAMARA	TE 206
3940	lec	6:00pm - 9:10pm	M	J.C. MOCK	TE 201
3941	lec	6:00pm - 9:10pm	W	J.C. MOCK	TE 201
3942	lec	6:00pm - 9:10pm	Th	J.C. MOCK	TE 201
3943	lec	6:00pm - 9:10pm	T	J.C. MOCK	TE 201
3944	lec	4:35pm - 7:45pm	F	J.C. MOCK	TE 201

SUPERVISION

SUPERVISION 001 ELEMENTS OF SUPERVISION (CSU) 3.00 UNITS

7831	lec	3:25 hrs/wk TBA	-	M.C. BESSLER	ON LINE
------	-----	-----------------	---	--------------	---------

• Please visit the online program homepage at <http://moodle.lattc.edu> prior to the start of class for directions, or see pages 82-84 of this schedule for more information.

SUPERVISION 011 ORAL COMMUNICATIONS 3.00 UNITS

Evening Class					
3076	lec	6:00pm - 9:15pm	Th	E.R. JOHNSON	K 204

SUPERVISION 941 COOPERATIVE EDUCATION - SUPERVISION (CSU) 4.00 UNITS

See page 85 for detail and meeting times

9220	lec	4:25 hrs/wk TBA	-	C.A. MORLEY MOWER	D 236
------	-----	-----------------	---	-------------------	-------

SUPPLY WATER TECHNOLOGY

SUPPLY WATER TECHNOLOGY 001 MODERN WATER WORKS I 3.00 UNITS

Evening Class					
4208	lec	6:00pm - 9:10pm	W	A. AMIR TEYMOORI	K 406

SUPPLY WATER TECHNOLOGY 941 COOPERATIVE EDUCATION - SUPPLY WATER TECHNOLOGY 4.00 UNITS

See page 85 for detail and meeting times

9248	lec	4:25 hrs/wk TBA	-	C.L. ANDERSON	D 236
------	-----	-----------------	---	---------------	-------

TAILORING

TAILORING 185 DIRECTED STUDY - TAILORING 1.00 UNIT

7234	lec	1:05 hrs/wk TBA	-	B.S. TORDA	D 234
Evening Class					
4312	lec	1:05 hrs/wk TBA	-	N.G. IAPAOLLO	D 105

TAILORING 233 MEN'S CUSTOM PATTERN DRAFTING AND DESIGN I	2.00 UNITS
7228 lab 8:35am - 3:05pm S B.S. TORDA	D 230
TAILORING 234 MEN'S CUSTOM PATTERN DRAFTING AND DESIGN II	2.00 UNITS
7229 lab 8:35am - 3:05pm S B.S. TORDA	D 230
TAILORING 250 TAILORING TECHNIQUE I Evening Class	2.00 UNITS
4315 lab 6:00pm - 9:10pm MW N.G. IAPAOLLO	D 105
TAILORING 251 TAILORING TECHNIQUES II Evening Class	2.00 UNITS
4316 lab 6:00pm - 9:10pm MW N.G. IAPAOLLO	D 105
TAILORING 252 TAILORING TECHNIQUES III Evening Class	2.00 UNITS
4317 lab 6:00pm - 9:10pm MW N.G. IAPAOLLO	D 105
TAILORING 253 TAILORING TECHNIQUES IV Evening Class	2.00 UNITS
4318 lab 6:00pm - 9:10pm MW N.G. IAPAOLLO	D 105
TAILORING 285 DIRECTED STUDY - TAILORING	2.00 UNITS
7235 lec 2:10 hrs/wk TBA - B.S. TORDA	D 234
Evening Class	
4313 lec 2:10 hrs/wk TBA - N.G. IAPAOLLO	D 105
TAILORING 385 DIRECTED STUDY - TAILORING	3.00 UNITS
7236 lec 3:10 hrs/wk TBA - B.S. TORDA	D 234
Evening Class	
4314 lec 3:10 hrs/wk TBA - N.G. IAPAOLLO	D 105

THEATER

THEATER 100 INTRODUCTION TO THE THEATER (UC:CSU)	3.00 UNITS
1560 lec 10:10am - 11:35am TTh R.K. TROPF	F 214
THEATER 270 BEGINNING ACTING (UC:CSU)	3.00 UNITS
1561 lec 11:45am - 1:10pm TTh C.R. WATSON	F 231

ATTENTION STUDENTS: ENROLL EARLY!!

For more information on how to enroll in your classes or to have other Student Services questions answered or about our "NEW" Queuing System located in the Student Services (ST) Building – First Floor, please refer to page 99.

VISUAL COMMUNICATIONS

VISUAL COMMUNICATIONS 100 GRAPHIC DESIGN I (CSU)	2.00 UNITS
7253 lec 7:00am - 7:45am TW R.N. HUBBARD	H 220
& lab 7:45am - 12:25pm TW R.N. HUBBARD	H 220
<i>(8 Week Class - Starts 8/30/2010, Ends 10/22/2010)</i>	
VISUAL COMMUNICATIONS 103 BASIC COMPUTER SYSTEMS (CSU)	2.00 UNITS
7254 lec 7:00am - 7:45am ThF G. EVANS	H 238
& lab 7:45am - 12:25pm ThF G. EVANS	H 238
<i>(8 Week Class - Starts 8/30/2010, Ends 10/22/2010)</i>	
VISUAL COMMUNICATIONS 105 DIGITAL PREPRESS I (CSU)	2.00 UNITS
7255 lec 7:00am - 7:45am TW G. EVANS	H 230
& lab 7:45am - 12:25pm TW G. EVANS	H 230
<i>(8 Week Class - Starts 10/25/2010, Ends 12/17/2010)</i>	
VISUAL COMMUNICATIONS 106 DRAWING I (CSU)	2.00 UNITS
7256 lec 7:00am - 7:45am ThF R.N. HUBBARD	H 220
& lab 7:45am - 12:25pm ThF R.N. HUBBARD	H 220
<i>(7 Week Class - Starts 10/25/2010, Ends 12/17/2010)</i>	
VISUAL COMMUNICATIONS 108 2-D DESIGN FUNDAMENTALS (CSU)	2.00 UNITS
7257 lec 7:00am - 9:15am M STAFF	H 208
VISUAL COMMUNICATIONS 112 DIGITAL PREPRESS II (CSU)	2.00 UNITS
7258 lec 7:00am - 7:45am TW G. EVANS	H 238
& lab 7:45am - 12:25pm TW G. EVANS	H 238
<i>(8 Week Class - Starts 8/30/2010, Ends 10/22/2010)</i>	
VISUAL COMMUNICATIONS 114 DIGITAL TYPESETTING (CSU)	2.00 UNITS
7259 lec 7:00am - 7:45am ThF C.J. RODRIGUEZ	H 208
& lab 7:45am - 12:25pm ThF C.J. RODRIGUEZ	H 208
<i>(8 Week Class - Starts 8/30/2010, Ends 10/22/2010)</i>	
VISUAL COMMUNICATIONS 115 GRAPHIC DESIGN II (CSU)	2.00 UNITS
7260 lec 7:00am - 7:45am ThF F.H. MORRIS	H 208
& lab 7:45am - 12:25pm ThF F.H. MORRIS	H 208
<i>(7 Week Class - Starts 10/25/2010, Ends 12/17/2010)</i>	
VISUAL COMMUNICATIONS 116 ADVERTISING CONCEPTS (CSU)	2.00 UNITS
7261 lec 7:00am - 7:45am TW F.H. MORRIS	H 208
& lab 7:45am - 12:25pm TW F.H. MORRIS	H 208
<i>(8 Week Class - Starts 10/25/2010, Ends 12/17/2010)</i>	

**VISUAL COMMUNICATIONS 118
DIGITAL DRAWING (CSU) 2.00 UNITS**

7262	lec	9:30am - 10:30am	M	R.N. HUBBARD	H 238
&	lab	10:30am - 2:00pm	M	R.N. HUBBARD	H 238

**VISUAL COMMUNICATIONS 119
DIGITAL PAGE LAYOUT (CSU) 2.00 UNITS**

7263	lec	12:35pm - 3:00pm	W	G. EVANS	H 238
------	-----	------------------	---	----------	-------

**VISUAL COMMUNICATIONS 120
DRAWING II (CSU) 2.00 UNITS**

7264	lec	7:00am - 7:45am	TW	W.T. ROBLES	H 208
&	lab	7:45am - 12:25pm	TW	W.T. ROBLES	H 208

(8 Week Class - Starts 8/30/2010, Ends 10/22/2010)

**VISUAL COMMUNICATIONS 124
COMPUTER ILLUSTRATION I (CSU) 2.00 UNITS**

7265	lec	7:00am - 7:45am	ThF	R.N. HUBBARD	H 209
&	lab	7:45am - 12:25pm	ThF	R.N. HUBBARD	H 209

(8 Week Class - Starts 8/30/2010, Ends 10/22/2010)

**VISUAL COMMUNICATIONS 126
PORTFOLIO DEVELOPMENT I (CSU) 2.00 UNITS**

7267	lec	7:00am - 7:45am	TW	R.N. HUBBARD	H 220
&	lab	7:45am - 12:25pm	TW	R.N. HUBBARD	H 220

(8 Week Class - Starts 10/25/2010, Ends 12/17/2010)

**VISUAL COMMUNICATIONS 127
DIGITAL PREPRESS III (CSU) 2.00 UNITS**

7266	lec	7:00am - 7:45am	ThF	G. EVANS	H 238
&	lab	7:45am - 12:25pm	ThF	G. EVANS	H 238

(7 Week Class - Starts 10/25/2010, Ends 12/17/2010)

**VISUAL COMMUNICATIONS 129
DIGITAL PHOTO MANIPULATION (CSU) 2.00 UNITS**

7269	lec	12:35pm - 1:35pm	TTh	R.N. HUBBARD	H 238
&	lab	1:35pm - 2:50pm	TTh	R.N. HUBBARD	H 238

**VISUAL COMMUNICATIONS 130
DRAWING III (CSU) 2.00 UNITS**

7270	lec	7:00am - 7:45am	TW	W.T. ROBLES	H 208
&	lab	7:45am - 12:25pm	TW	W.T. ROBLES	H 208

(8 Week Class - Starts 8/30/2010, Ends 10/22/2010)

**VISUAL COMMUNICATIONS 131
COMPUTER ILLUSTRATION II (CSU) 2.00 UNITS**

7271	lec	7:00am - 7:45am	ThF	R.N. HUBBARD	H 209
&	lab	7:45am - 12:25pm	ThF	R.N. HUBBARD	H 209

(8 Week Class - Starts 8/30/2010, Ends 10/22/2010)

**VISUAL COMMUNICATIONS 132
PORTFOLIO DEVELOPMENT II (CSU) 2.00 UNITS**

7273	lec	7:00am - 7:45am	TW	R.N. HUBBARD	H 220
&	lab	7:45am - 12:25pm	TW	R.N. HUBBARD	H 220

(8 Week Class - Starts 10/25/2010, Ends 12/17/2010)

**VISUAL COMMUNICATIONS 133
DIGITAL PORTFOLIO PREPARATION (CSU) 2.00 UNITS**

7272	lec	7:00am - 7:45am	ThF	G. EVANS	H 238
&	lab	7:45am - 12:30pm	ThF	G. EVANS	H 238

(7 Week Class - Starts 10/25/2010, Ends 12/17/2010)

**VISUAL COMMUNICATIONS 134
GRAPHIC DESIGN BUSINESS PRACTICES (CSU) 2.00 UNITS**

7274	lec	7:00am - 9:15am	M	D.A. ROBINSON	H 208
------	-----	-----------------	---	---------------	-------

**VISUAL COMMUNICATIONS 185
DIRECTED STUDY - VISUAL COMMUNICATIONS 1.00 UNIT**

7280	lec	1:05 hrs/wk TBA	-	R.N. HUBBARD	H 220
------	-----	-----------------	---	--------------	-------

**VISUAL COMMUNICATIONS 204
FLASH MOTION GRAPHICS (BEGINNING LEVEL) (CSU) 2.00 UNITS**

7283	lec	9:30am - 10:30am	M	G. EVANS	H 238
&	lab	10:30am - 2:00pm	M	G. EVANS	H 238

**VISUAL COMMUNICATIONS 285
DIRECTED STUDY - VISUAL COMMUNICATIONS 2.00 UNITS**

7282	lec	2:10 hrs/wk TBA	-	R.N. HUBBARD	H 220
------	-----	-----------------	---	--------------	-------

**VISUAL COMMUNICATIONS 385
DIRECTED STUDY - VISUAL COMMUNICATIONS 3.00 UNITS**

7284	lec	3:10 hrs/wk TBA	-	R.N. HUBBARD	H 220
------	-----	-----------------	---	--------------	-------

WASTEWATER TECHNOLOGY

**WASTEWATER TECHNOLOGY 012
WASTEWATER OPERATIONS I 3.00 UNITS**

Evening Class

4122	lec	6:00pm - 9:10pm	Th	V. ABKIAN	K 406
------	-----	-----------------	----	-----------	-------

**WASTEWATER TECHNOLOGY 016
WASTEWATER OPERATIONS V 3.00 UNITS**

Evening Class

4126	lec	6:00pm - 9:10pm	T	M.A. ABDELAAL	K 406
------	-----	-----------------	---	---------------	-------

**WASTEWATER TECHNOLOGY 941
COOPERATIVE EDUCATION - WASTEWATER TECHNOLOGY 4.00 UNITS**

See page 85 for detail and meeting times

9252	lec	4:25 hrs/wk TBA	-	C.A. MORLEY MOWER	D 236
------	-----	-----------------	---	-------------------	-------

WELDING GAS AND ELECTRIC

**WELDING GAS AND ELECTRIC 100
METAL SCULPTURE I 3.00 UNITS**

Evening Class

4810	lec	6:10pm - 6:50pm	MTh	STAFF	F 151A
&	lab	6:50pm - 9:10pm	MTh	STAFF	F 156

**WELDING GAS AND ELECTRIC 111
ACETYLENE WELDING, CUTTING AND BRAZING 6.00 UNITS**

8200	lec	7:00am - 8:25am	M	C.A. CHANCY	F 156
&	lec	8:30am - 11:35am	MTWThF	C.A. CHANCY	F 156

WELDING GAS AND ELECTRIC 112 WELDING RELATED TECHNICAL INSTRUCTIONS I	3.00 UNITS
8202 lec 7:00am - 8:15am WF C.A. CHANCY F 150	
WELDING GAS AND ELECTRIC 113 APPLIED MATHEMATICS I	3.00 UNITS
8203 lec 7:00am - 8:25am TTh C.A. CHANCY F 150	
WELDING GAS AND ELECTRIC 121 ELECTRIC WELDING I	6.00 UNITS
8220 lab 7:00am - 8:25am M C.A. CHANCY F 150 & lec 8:30am - 11:35am MTWThF C.A. CHANCY F 156	
WELDING GAS AND ELECTRIC 124 BLUEPRINT READING I	3.00 UNITS
8221 lec 11:35am - 1:00pm TTh C.A. CHANCY F 150	
WELDING GAS AND ELECTRIC 125 APPLIED MATHEMATICS II	3.00 UNITS
8222 lec 11:35am - 12:50pm WF C.A. CHANCY F 150	
WELDING GAS AND ELECTRIC 131 ELECTRIC WELDING II	6.00 UNITS
8223 lec 7:00am - 8:25am M L.M. LEGOHN F 151 & lab 8:30am - 11:35am MTWThF L.M. LEGOHN F 156	
WELDING GAS AND ELECTRIC 132 BLUEPRINT READING II	3.00 UNITS
8224 lec 7:00am - 8:25am TTh L.M. LEGOHN F 151	
WELDING GAS AND ELECTRIC 133 WELDING RELATED TECHNICAL INSTRUCTION III	3.00 UNITS
8225 lec 7:00am - 8:25am WF L.M. LEGOHN F 151	
WELDING GAS AND ELECTRIC 141 ELECTRIC WELDING III	6.00 UNITS
8240 lec 11:35am - 1:00pm M L.M. LEGOHN F 151 & lab 8:30am - 11:35am MTWThF L.M. LEGOHN F 156	

WELDING GAS AND ELECTRIC 142 INERT GAS WELDING (TIG & MIG)	3.00 UNITS
8241 lec 11:35am - 1:00pm TTh L.M. LEGOHN F 151	
WELDING GAS AND ELECTRIC 143 WELDING RELATED TECHNICAL INSTRUCTION IV	3.00 UNITS
8242 lec 11:35am - 12:50pm WF L.M. LEGOHN F 151	
WELDING GAS AND ELECTRIC 150 AWS D1.1 CERTIFICATION	6.00 UNITS
Evening Class	
4804 lec 8:30am - 11:35am MWF STAFF F 156 & lab 1:00pm - 2:00pm MWF STAFF F 156	
WELDING GAS AND ELECTRIC 201 WELDING-GAS AND ELECTRIC I	2.00 UNITS
Evening Class	
4814 lab 8:00am - 2:20pm S C.A. CHANCY F 156	
WELDING GAS AND ELECTRIC 201A WELDING-GAS AND ELECTRIC I	1.00 UNIT
Evening Classes	
4802 lab 6:00pm - 9:10pm W R. GALVEZ F 156 4809 lab 6:00pm - 9:10pm T R. GALVEZ F 156 5502 lab 6:00pm - 9:10pm W R. GALVEZ F 156	
WELDING GAS AND ELECTRIC 201B WELDING-GAS AND ELECTRIC I	1.00 UNIT
Evening Classes	
4803 lab 6:00pm - 9:10pm T R. GALVEZ F 156 4806 lab 6:00pm - 9:10pm W R. GALVEZ F 156	
WELDING GAS AND ELECTRIC 202A WELDING-GAS AND ELECTRIC II	1.00 UNIT
Evening Class	
4801 lab 6:00pm - 9:10pm W R. GALVEZ F 156	
WELDING GAS AND ELECTRIC 210 METAL SCULPTING LABORATORY	2.00 UNITS
Evening Class	
4812 lab 6:00pm - 9:10pm ThF R. NEWELL F 156	
WELDING GAS AND ELECTRIC 941 COOPERATIVE EDUCATION - WELDING GAS AND ELECTRIC	4.00 UNITS
See page 85 for detail and meeting times	
9256 lec 4:25 hrs/wk TBA - C.L. ANDERSON D 236	



**Don't Wait,
Get Online!!!**

- Registration
- FAQ's
- Counseling
- Financial Aid
- Grades
- Orientation

www.lattc.edu

**ATTENTION STUDENTS:
ENROLL EARLY!!**

For more information on how to enroll in your classes or to have other Student Services questions answered or about our "NEW" Queuing System located in the Student Services (ST) Building – First Floor, please refer to page 99.

NONCREDIT CLASSES

BASIC SKILLS

BASIC SKILLS 002CE 0.00 UNIT

BASIC ENGLISH SKILLS (NDA)

8740 lec 8:30am - 10:35am MTWTh STAFF E 210
(7 Week Class - Starts 10/25/2010, Ends 12/10/2010)

8741 lec 8:30am - 10:25am MTWTh STAFF E 210
(6 Week Class - Starts 9/13/2010, Ends 10/21/2010)

Evening Class

5740 lec 6:00pm - 8:55pm TTh E. GUTIERREZ E 206
(11 Week Class - Starts 9/14/2010, Ends 11/23/2010)

BASIC SKILLS 023CE 0.00 UNIT

COLLEGE AND SCHOLASTIC ASSESSMENT PREPARATION (NDA)

8700 lec 8:30am - 10:05am MW STAFF ST 316
& lec 10:15am - 11:50am MW STAFF E 208

& lec 8:30am - 10:05am TTh STAFF ST 316
& lec 10:15am - 11:50am TTh STAFF E 208

(5 Week Class - Starts 9/7/2010, Ends 10/7/2010)

8701 lec 8:30am - 10:05am MW STAFF E 206
& lec 10:15am - 11:50am MW STAFF ST 316

& lec 8:30am - 10:05am TTh STAFF E 206
& lec 10:15am - 11:50am TTh STAFF ST 316

(5 Week Class - Starts 9/7/2010, Ends 10/7/2010)

8702 lec 8:30am - 10:05am MW STAFF ST 316
& lec 10:15am - 11:50am MW STAFF E 208

& lec 8:30am - 10:05am TTh STAFF ST 316
& lec 10:15am - 11:50am TTh STAFF E 208

(5 Week Class - Starts 10/11/2010, Ends 11/10/2010)

8703 lec 8:30am - 10:05am MW STAFF E 206
& lec 10:15am - 11:50am MW STAFF ST 316

& lec 8:30am - 10:05am TTh STAFF E 206
& lec 10:15am - 11:50am TTh STAFF ST 316

(5 Week Class - Starts 10/11/2010, Ends 11/10/2010)

8704 lec 8:30am - 10:05am MW STAFF ST 316
& lec 10:15am - 11:50am MW STAFF E 208

& lec 8:30am - 10:05am TTh STAFF ST 316
& lec 10:15am - 11:50am TTh STAFF E 208

(4 Week Class - Starts 11/15/2010, Ends 12/9/2010)

8705 lec 8:30am - 10:05am MW STAFF E 206
& lec 10:15am - 11:50am MW STAFF ST 316

& lec 8:30am - 10:05am TTh STAFF E 206
& lec 10:15am - 11:50am TTh STAFF ST 316

(4 Week Class - Starts 11/15/2010, Ends 12/9/2010)

& lec 1:05 hrs/wk TBA A. TOM MIURA ST 316

(4 Week Class - Starts 11/15/2010, Ends 12/9/2010)

8710 lec 12:00pm - 1:35pm MW STAFF ST 316
& lec 1:45pm - 3:20pm MW STAFF E 208

& lec 12:00pm - 1:35pm TTh STAFF ST 316
& lec 1:45pm - 3:20pm TTh STAFF E 208

(5 Week Class - Starts 9/7/2010, Ends 10/7/2010)

8711 lec 12:00pm - 1:35pm MW STAFF E 206
& lec 1:45pm - 3:20pm MW STAFF ST 316

& lec 12:00pm - 1:35pm TTh STAFF E 206
& lec 1:45pm - 3:20pm TTh STAFF ST 316

(6 Week Class - Starts 10/4/2010, Ends 11/10/2010)

8712 lec 12:00pm - 1:35pm MW STAFF ST 316
& lec 1:45pm - 3:20pm MW STAFF E 208

& lec 12:00pm - 1:35pm TTh STAFF ST 316
& lec 1:54PM - 3:30pm TTh STAFF E 208

(5 Week Class - Starts 10/11/2010, Ends 11/10/2010)

8713 lec 12:00pm - 2:20pm MW STAFF E 208
& lec 12:00pm - 2:20pm TTh STAFF E 208

& lec 8:05 hrs/wk TBA STAFF E 206

(4 Week Class - Starts 11/15/2010, Ends 12/9/2010)

8745 lec 12:50pm - 2:20pm F M. GALINDO E 216
& lec 2:00 hrs/wk TBA N.D. MARTINEZ E 216

(13 Week Class - Starts 9/10/2010, Ends 12/9/2010)

8801 lec 2:45pm - 4:40pm MWThF STAFF ADAM MS

(9 Week Class - Starts 9/20/2010, Ends 11/19/2010)

• John Adams Middle School, 151 West 30th Street, Los Angeles, CA 90007. Contact Jorge Calderon.
8802 lec 8:00am - 12:40pm S J. CALDERON ADAM MS

& lec 2:10 hrs/wk TBA A. TOM MIURA E 208

(8 Week Class - Starts 9/25/2010, Ends 11/19/2010)

• John Adams Middle School, 151 West 30th Street, Los Angeles, CA 90007. Contact Jorge Calderon.
8807 lec 9:00am - 12:15pm S N.D. MARTINEZ E 216

& lec 1:15 hrs/wk TBA A. TOM MIURA E 208

(15 Week Class - Starts 9/11/2010, Ends 12/19/2010)

8810 lec 8:00am - 1:10pm S STAFF USC WPH
& lec 2:30 hrs/wk TBA A. TOM MIURA E 208

(11 Week Class - Starts 10/2/2010, Ends 12/11/2010)

• USC-Waite Phillips Hall of Education, 3470 Trousdale Parkway
8811 lec 8:00am - 1:10pm S J. ARTELES USC WPH

& lec 1:30 hrs/wk TBA A. TOM MIURA E 208

(11 Week Class - Starts 10/2/2010, Ends 12/11/2010)

8812 lec 8:00am - 1:10pm S STAFF USC WPH
& lec 1:30 hrs/wk TBA A. TOM MIURA E 208

(11 Week Class - Starts 10/2/2010, Ends 12/11/2010)

Evening Classes

5740 lec 6:00pm - 8:55pm TTh E. GUTIERREZ E 206
(11 Week Class - Starts 9/14/2010, Ends 11/23/2010)

5700 lec 6:00pm - 7:30pm MW J. CALDERON E 216
& lec 7:40pm - 9:10pm MW J. CALDERON TBA

& lec 6:00pm - 7:30pm TTh STAFF E 216
& lec 7:40pm - 9:10pm TTh STAFF TBA

(5 Week Class - Starts 9/7/2010, Ends 10/7/2010)

5701 lec 6:00pm - 7:30pm MW J. CALDERON E 216
& lec 7:40pm - 9:15pm MW J. CALDERON TBA

& lec 6:00pm - 7:30pm TTh STAFF E 216
& lec 7:40pm - 9:15pm TTh STAFF TBA

(5 Week Class - Starts 10/11/2010, Ends 11/10/2010)

5702	lec	6:00pm - 7:35pm	MW	J. CALDERON	E 216
&	lec	7:45pm - 9:20pm	MW	J. CALDERON	TBA
&	lec	6:00pm - 7:35pm	TTh	STAFF	E 216
&	lec	7:45pm - 9:20pm	TTh	STAFF	TBA
&	lec	1:00 hrs/wk	TBA	STAFF	ST 316
<i>(4 Week Class - Starts 11/15/2010, Ends 12/9/2010)</i>					

BASIC SKILLS 041CE **0.00 UNIT**
SOFTSKILL BASICS 1A - JOB SEARCH PLANNING (NDA)
Evening Class

5770	lec	6:00pm - 8:50pm	W	A.K. SAMSTAG	E 210
<i>(3 Week Class - Starts 9/22/2010, Ends 10/6/2010)</i>					

BASIC SKILLS 042CE **0.00 UNIT**
SOFTSKILL BASICS 1B - THE SUCCESSFUL JOB SEARCH (NDA)

8770	lec	8:50 hrs/wk	TBA	A.K. SAMSTAG	U AW
<i>(6 Week Class - Starts 11/1/2010, Ends 12/10/2010)</i>					
• UAW - 3965 S. VERMONT AVENUE, LOS ANGELES, CA 90037					

Evening Class

5771	lec	6:00pm - 8:50pm	W	A.K. SAMSTAG	E 210
<i>(3 Week Class - Starts 10/13/2010, Ends 10/27/2010)</i>					

BASIC SKILLS 043CE **0.00 UNIT**
SOFTSKILL BASICS 1C - PRE-EMPLOYMENT READINESS (NDA)

8771	lec	8:50 hrs/wk	TBA	A.K. SAMSTAG	U AW
<i>(6 Week Class - Starts 11/1/2010, Ends 12/10/2010)</i>					
• UAW - 3965 S. VERMONT AVENUE, LOS ANGELES, CA 90037					

Evening Class

5772	lec	6:00pm - 8:50pm	W	A.K. SAMSTAG	E 210
<i>(3 Week Class - Starts 11/3/2010, Ends 11/17/2010)</i>					

BASIC SKILLS 046CE **0.00 UNIT**
MICROSOFT WINDOWS BASICS (NDA)

8780	lec	12:00pm - 2:50pm	F	STAFF	TBA
<i>(3 Week Class - Starts 9/17/2010, Ends 10/1/2010)</i>					

BASIC SKILLS 047CE **0.00 UNIT**
MICROSOFT WORD BASICS (NDA)

8781	lec	12:00pm - 2:50pm	F	STAFF	TBA
<i>(3 Week Class - Starts 10/8/2010, Ends 10/22/2010)</i>					

Evening Class

5780	lec	6:00pm - 8:50pm	M	STAFF	TBA
<i>(3 Week Class - Starts 9/20/2010, Ends 10/4/2010)</i>					

BASIC SKILLS 048CE **0.00 UNIT**
MICROSOFT EXCEL BASICS (NDA)

8783	lec	12:00pm - 2:50pm	F	STAFF	TBA
<i>(3 Week Class - Starts 10/29/2010, Ends 11/12/2010)</i>					

BASIC SKILLS 050CE **0.00 UNIT**
MICROSOFT POWERPOINT BASICS (NDA)

8784	lec	12:00pm - 2:50pm	F	STAFF	TBA
<i>(3 Week Class - Starts 11/19/2010, Ends 12/10/2010)</i>					

BASIC SKILLS 051CE **0.00 UNIT**
INTERNET BASICS (NDA)

8786	lec	8:30am - 11:20am	F	A. TOM MIURA	ST 316
<i>(3 Week Class - Starts 9/3/2010, Ends 9/17/2010)</i>					

8787	lec	8:30am - 11:20am	F	A. TOM MIURA	ST 316
<i>(3 Week Class - Starts 9/24/2010, Ends 10/8/2010)</i>					

8788	lec	8:30am - 11:20am	F	A. TOM MIURA	ST 316
<i>(1 Week Class - Starts 10/15/2010, Ends 10/20/2010)</i>					

8789	lec	8:30am - 11:20am	F	A. TOM MIURA	ST 316
<i>(3 Week Class - Starts 11/5/2010, Ends 11/19/2010)</i>					

Evening Class

5781	lec	6:00pm - 8:50pm	M	STAFF	TBA
<i>(3 Week Class - Starts 10/11/2010, Ends 10/25/2010)</i>					

BASIC SKILLS 055CE **0.00 UNIT**
SOFTSKILL BASICS 3B - IMAGE, ETIQUETTE, AND INTERPERSONAL COMMUNICATIONS (NDA)

Evening Class

5773	lec	6:00pm - 8:50pm	W	A.K. SAMSTAG	E 210
<i>(3 Week Class - Starts 11/24/2010, Ends 12/8/2010)</i>					

BASIC SKILLS 065CE **0.00 UNIT**
FINANCIAL LITERACY - CREDIT BASICS (NDA)

Evening Class

5775	lec	6:00pm - 8:50pm	W	A. TOM MIURA	E 210
<i>(3 Week Class - Starts 11/22/2010, Ends 12/6/2010)</i>					

BASIC SKILLS 066CE **0.00 UNIT**
FINANCIAL LITERACY - PERSONAL MONEY MANAGEMENT (NDA)

Evening Class

5774	lec	6:00pm - 8:50pm	W	A. TOM MIURA	E 210
<i>(3 Week Class - Starts 11/1/2010, Ends 11/15/2010)</i>					

BASIC SKILLS 075CE **0.00 UNIT**
INTRODUCTION TO POST-SECONDARY EDUCATION (NDA)

8750	lec	9:00am - 11:05am	MTWTh	A. TOM MIURA	E 221
<i>(1 Week Class - Starts 8/30/2010, Ends 9/2/2010)</i>					

8751	lec	1:05 hrs/wk	TBA	A. TOM MIURA	TBA
<i>(1 Week Class - Starts 8/30/2010, Ends 9/2/2010)</i>					

8752	lec	9:00am - 11:50am	TWTh	A. TOM MIURA	E 221
<i>(1 Week Class - Starts 9/7/2010, Ends 9/9/2010)</i>					

8753	lec	1:05 hrs/wk	TBA	A. TOM MIURA	TBA
<i>(1 Week Class - Starts 9/7/2010, Ends 9/9/2010)</i>					

8754	lec	9:00am - 11:05am	MTWTh	A. TOM MIURA	E 221
<i>(1 Week Class - Starts 9/13/2010, Ends 9/16/2010)</i>					

8756	lec	9:00am - 11:05am	MTWTh	A. TOM MIURA	E 221
<i>(1 Week Class - Starts 10/4/2010, Ends 10/7/2010)</i>					

8757	lec	9:00am - 11:05am	MTWTh	A. TOM MIURA	E 221
<i>(1 Week Class - Starts 10/11/2010, Ends 10/14/2010)</i>					

8758	lec	9:00am - 11:05am	MTWTh	A. TOM MIURA	E 221
<i>(1 Week Class - Starts 10/11/2010, Ends 10/14/2010)</i>					

8759	lec	9:00am - 11:50am	MTW	A. TOM MIURA	E 221
<i>(1 Week Class - Starts 11/8/2010, Ends 11/10/2010)</i>					

Evening Classes

5750	lec	6:00pm - 8:05pm	MTWTh	A. TOM MIURA	E 221
<i>(1 Week Class - Starts 8/30/2010, Ends 9/2/2010)</i>					

5751	lec	1:05 hrs/wk	TBA	A. TOM MIURA	TBA
<i>(1 Week Class - Starts 8/30/2010, Ends 9/2/2010)</i>					

5752	lec	1:05 hrs/wk	TBA	A. TOM MIURA	TBA
<i>(1 Week Class - Starts 9/7/2010, Ends 9/9/2010)</i>					

5753	lec	6:00pm - 8:05pm	MTWTh	A. TOM MIURA	E 221
<i>(1 Week Class - Starts 10/4/2010, Ends 10/7/2010)</i>					

BASIC SKILLS 077CE 0.00 UNIT
FUNDAMENTAL FOR WORKPLACE SUCCESS - TEAMWORK (NDA)

8772 lec 9:30am - 12:20pm S M. GALINDO E 214
 (14 Week Class - Starts 9/1/2010, Ends 12/11/2010)

BASIC SKILLS 078CE 0.00 UNIT
FUNDAMENTALS FOR WORKPLACE SUCCESS II - EFFECTIVE COMMUNICATION AND LEADERSHIP SKILLS (NDA)

8773 lec 8:30am - 11:00am F M. GALINDO E 206
 (13 Week Class - Starts 9/10/2010, Ends 12/10/2010)

8774 lec 12:00pm - 2:30pm F A. TOM MIURA E 206
 (13 Week Class - Starts 9/10/2010, Ends 12/10/2010)

ENGLISH AS A SECOND LANGUAGE

ENGLISH AS A SECOND LANGUAGE - NONCREDIT 006CE 0.00 UNIT
ENGLISH AS A SECOND LANGUAGE - 0 (NDA)

8823 lec 10:00am - 1:20pm MW O. PIEROLA SE IU
 (8 Week Class - Starts 9/6/2010, Ends 10/27/2010)
 • SEIU, 1247 W. 74th Street, Los Angeles, CA 90017

ENGLISH AS A SECOND LANGUAGE - NONCREDIT 007CE 0.00 UNIT
ENGLISH AS A SECOND LANGUAGE - 1 (NDA)

8824 lec 10:00am - 1:35pm MW O. PIEROLA SE IU
 (7 Week Class - Starts 11/1/2010, Ends 12/15/2010)
 • SEIU, 1247 W. 74th Street, Los Angeles, CA 90017

Evening Class

5825 lec 6:30pm - 8:45pm MW R.A. VELASQUEZ E 206
 (11 Week Class - Starts 9/13/2010, Ends 11/24/2010)

VOCATIONAL EDUCATION

VOCATIONAL EDUCATION 080CE 0.00 UNIT
BANK TELLER TRAINING (NDA)

Evening Class

5855 lec 6:00pm - 9:05pm TTh D. TRIGGS E 210
 (12 Week Class - Starts 9/21/2010, Ends 12/9/2010)

VOCATIONAL EDUCATION 108CE 0.00 UNIT
COMPUTER TECHNOLOGY IN THE WORKPLACE (NDA)

8820 lec 10:00am - 1:10pm TTh O. PIEROLA SE IU
 (8 Week Class - Starts 9/7/2010, Ends 10/28/2010)

• SEIU, 1247 W. 74th Street, Los Angeles, CA 90017

8821 lec 10:00am - 1:15pm TTh O. PIEROLA SE IU
 (7 Week Class - Starts 11/2/2010, Ends 12/16/2010)

• SEIU, 1247 W. 74th Street, Los Angeles, CA 90017

8851 lec 10:10am - 12:15pm MW O.K. KAPAKU K 305
 (12 Week Class - Starts 9/27/2010, Ends 12/19/2010)

8852 lec 8:00am - 10:15am TTh V.M. EMERSON K 208
 (12 Week Class - Starts 9/28/2010, Ends 12/19/2010)

ATTENTION STUDENTS: ENROLL EARLY!!

For more information on how to enroll in your classes or to have other Student Services questions answered or about our "NEW" Queuing System located in the Student Services (ST) Building – First Floor, please refer to page 99.



**Don't Wait,
Get Online!!!**

- Registration
- FAQ's
- Counseling
- Financial Aid
- Grades
- Orientation

www.lattfc.edu

LATTC ON-LINE CLASSES

Fall 2010 Online Student Orientations to Moodle and Mahara:

Orientations will be given on:

- Tuesday, August 31 from 6 - 7:30 pm, Room - TE-501
- Tuesday, September 7 from 6 - 7:30 pm, Room - TE-501
- Saturday, September 11 from 9-11 am, Room - TE-501
- Sunday, September 19 from 9-11 am, Room - TE-501

Students who cannot attend orientation on campus can do video tutorials.

What do I need in order to take an online class?

You'll need:

1. Computer access where you can regularly connect to the internet, plus
2. Sufficient computer skills to send/receive email and navigate the World Wide Web, and
3. A valid and currently-used email address in the SIS plus ability to log into the SIS.

How do I register for an online class?

1. If you're already a LATTC student, just enroll in your online class as you would any other, or
2. If you're new to LATTC, you'll need to enroll in the college first. Please go to <http://www.lacolleges.net/admissions/> to enroll online. Once you're enrolled in the college, you can proceed to register for your online class

I've registered. Now what ?

1. Go to the LATTC Online Program home page at <http://moodle.lattc.edu>
2. Download the Online Student Guide for your semester and read it carefully
3. Be sure to check if your class requires a campus edition of a textbook to coordinate with your online class. If you purchase the textbook at another campus, the key may not work for your LATTC class.
4. Check the Technical Help link to on-line college bookstore <http://college.lattc.edu/bookstore> to get information on preparing your computer to take online classes. You'll need to be able to enable pop-ups and cookies on your computer in order for your online class to work.

Students who will be using the Moodle course management system should go to <http://moodle.lattc.edu> and follow the directions. Students who have a class using another course management system will need to either attend the scheduled class orientation or follow all directions on the class home page to set up the software.

Are there any special meetings, either on campus or online?

Each teacher has the right to request either on-campus or online meetings if they so desire. Some of the reasons they may choose to require these meetings is to ensure the student is who s/he claims to be and is the person actually doing the work and or tests. Or, teachers may require an on-campus meeting to provide materials or an orientation to help students get off to a great start.

Classes have already started. How do I get into an online class?

Send the instructor an email request to add the class. This email must come from the ID listed in the SIS. Include your name, student ID number, and the class name and section number in your email. Full directions and instructor email can be found on Moodle homepage "Adding a Closed Online Course" link.

What if I need additional information?

You can contact the Online-Program Coordinator, Linda Delzeit-McIntyre, at 213/763-3733, or email her at delzeit@lattc.edu.



LATTTC ON-LINE CLASSES

Administration of Justice 2 – Concepts of Criminal Law http://wellness.lattc.edu/elarton/AJ2.html (Aug. 30 to Dec. 18)	7878	3	M
Anthropology 101 – Human Biological Evolution (Physical Anthropology) http://wellness.lattc.edu/phuld/anthro101.html (Aug. 30 to Dec. 18)	7971	3	M
Art 101 – Survey of Art History I http://wellness.lattc.edu/online/art101.html (Aug. 30 to Dec. 18) http://wellness.lattc.edu/online/art101.html (Oct. 11 to Dec. 19)	7940 7944	3	M
Art 104 – Art Appreciation II http://wellness.lattc.edu/online/art104.html (Aug. 30 to Dec. 18)	7942	3	M
CAOT 82 – Microcomputer Software Survey in the Office http://wellness.lattc.edu/online/caot82.html (Aug. 30 to Dec. 18)	7959	3	M
CAOT 84 – Microcomputer Office Applications: Word Processing http://wellness.lattc.edu/online/caot84.html (Aug. 30 to Dec. 18)	7962	3	M
CAOT 85 – Microcomputer Office Applications: Spreadsheet http://wellness.lattc.edu/online/caot85.html (Aug. 30 to Dec. 18)	7863	3	M
CAOT 134 – How to Teach an Online Course http://wellness.lattc.edu/online/caot134.html (Aug. 30 to Dec. 18)	7960	1.5	M
Child Development 001 – Child Growth and Development http://wellness.lattc.edu/online/ChildDev1.html (Aug. 30 to Dec. 18)	7931	3	M
Electronics Technology 161 – F.C.C. Radio Operator’s License http://wellness.lattc.edu/chavez/electech161.html (Aug. 30 to Dec. 18)	7832	3	M
English 101 – College Reading and Composition I **[AT] and/or [PR]** http://wellness.lattc.edu/lmoreno/english101.html (Aug. 30 to Dec. 18)	7950	3	M
English 205 – English Literature **[PR]** http://wellness.lattc.edu/lmoreno/english205.html (Aug. 30 to Dec. 18)	7958	3	M
Environmental Science 1 – The Human Environment http://wellness.lattc.edu/online/envsci1.html (Aug. 30 to Dec. 18)	7828	3	M
Geography 2 – Cultural Elements of Geography http://wellness.lattc.edu/online/geography2.html (Sept. 28 to Dec. 18)	7850	3	M
Health 8 – Women’s Personal Health http://wellness.lattc.edu/online/health8.html (Aug. 30 to Dec. 18)	7900	3	M
Health 11 – Principles of Healthful Living http://wellness.lattc.edu/online/health11.html (Aug. 30 to Dec. 18)	7901	3	M
History 11 – Political and Social History of the U.S. I http://wellness.lattc.edu/restrada/history11.html (Aug. 30 to Dec. 18)	7978	3	M
History 12 – Political and Social History of the United States II http://wellness.lattc.edu/restrada/history12.html (Sept. 28 to Dec. 18)	7852	3	M
Humanities 001 – Cultural Pattern of Western Civilization http://wellness.lattc.edu/gonzalez/humanities1.html (Aug. 30 to Dec. 18)	7941	3	M
Labor Studies 5 – Greivance and Arbitration Procedures http://wellness.lattc.edu/online/laborstudies5.html (Aug. 30 to Dec. 18)	7860	3	M

LATTC ON-LINE CLASSES

Labor Studies 20 - Labor Law http://wellness.lattc.edu/online/laborstudies20.html (Aug. 30 to Dec. 18)	7861	3	M
Marketing 1 - Principles of Selling http://wellness.lattc.edu/bessler/marketing1.html (Aug. 30 to Dec. 18)	7957	3	M
Marketing 21 - Principles of Marketing http://wellness.lattc.edu/bessler/market21.html (Aug. 30 to Dec. 18)	7964	3	M
Math 105 - Arithmetic http://wellness.lattc.edu/tmeftagh/math105.html (Aug. 30 to Dec. 18)	7916	3	O
Math 112 - Pre-Algebra http://wellness.lattc.edu/tmeftagh/math112.html (Aug. 30 to Dec. 18)	7917	3	O
Math 115 - Elementary Algebra http://wellness.lattc.edu/tmeftagh/math115.html (Aug. 30 to Dec. 18)	7920	5	O
Math 125 - Intermediate Algebra http://wellness.lattc.edu/tmeftagh/math125.html (Aug. 30 to Dec. 18)	7921	5	O
Math 227 - Statistics http://wellness.lattc.edu/bakman/math227.html (Aug. 30 to Dec. 18)	7922	4	O
PhysEd 750 - Sports Ethics http://wellness.lattc.edu/online/pe750.html (Aug. 30 to Dec. 18)	7915	3	M
PhysEd 762 - Ancient Olympic Games http://wellness.lattc.edu/online/pe762.html (Aug. 30 to Dec. 18)	7907	3	M
Political Science 1 - The Government of the United States http://wellness.lattc.edu/online/polisci1.html (Aug. 30 to Dec. 18)	7972	3	M
Psychology 1- General Psychology http://wellness.lattc.edu/koritzke/psych1.html (Aug. 30 to Dec. 18)	7975	3	M
Psychology 41- Lifespan Psychology: Infancy to Old Age http://wellness.lattc.edu/koritzke/psych41.html (Aug. 30 to Dec. 18)	7981	3	M
Psychology 69- Psychology in film http://wellness.lattc.edu/koritzke/psych69.html (Aug. 30 to Dec. 18)	7983	3	M
Refrigeration / Air Conditioning 208 - Refrigerant Management - EPA 608 Certification http://wellness.lattc.edu/construction/refac208.html (Aug. 30 to Dec. 18)	7866	4	M
Refrigeration / Air Conditioning 209 - North American Technician Excellence (NATE) - Certificate Preparation http://wellness.lattc.edu/online/refac209.html (Aug. 30 to Dec. 18)	7867	4	M
Sociology 1 - Introduction to Sociology http://wellness.lattc.edu/jgarcia/sociology1.html (Aug. 30 to Dec. 18)	7875	3	M
Supervision 1 - Elements of Supervision http://wellness.lattc.edu/bessler/supervision1.html (Aug. 30 to Dec. 18)	7831	3	M

Class Management Software (CMS) Codes: M = Moodle; O= Other web-based software.
Symbols indicate: [PR] = pre-requisite required; [AT] = assessment test required

WORK EXPERIENCE THERE IS NO SUBSTITUTE



Internships Through Cooperative Work Experience Education

This program allows students to earn college units for their on-the-job learning experiences. Students employed for 200 hours or more per week on a job related to their major are eligible to earn 4 units. Students who are employed in a job not related to their major may earn 3 units of credit. Through cooperation with their employer and the student, the cooperative education coordinator will aid the students in writing learning objectives to be completed on the job. Assistance will be given in preparing a learning agreement during the classroom sessions listed below.



Students employed in a job not related to their major should enroll in:

COOP ED General Course: 395

Section: 9001
Units: 3
Room: D-236

Students employed in a job related to their major should enroll in:

COOP ED MAJOR Course: 941

Section: See schedule
Units: 4
Room: D-236

Enrollment

The appropriate section number is listed in the schedule for most disciplines. You may enroll in the course by adding it to your directory card as you enroll for your regular classes. If the section number for your discipline is not listed, please attend the first class sessions listed below after the semester begins to add the course. You may phone (213) 763-3642 for assistance or e-mail interns@lattc.edu.

Attendance

You will meet with the instructor one hour weekly during the first six weeks of the semester at the flexible sessions listed below. Your attendance is essential to the program as the instructor will only be available at this classroom for the first six weeks. During this period the instructor will aid you in preparing documents necessary to qualify you for the program. All meetings are over by the end of the sixth week. For additional information you may call (213) 763-3642 preferably after 1:00p.m. The sessions listed below will begin the first week of the semester. **The last day to add the course will be September 10, 2010.** The meetings will be completed by October 7, 2010. Sessions are scheduled for 50 minutes.

DAY	CLASS MEETING	ROOM
Monday	5:00 p.m. only	D-236
Wednesday	12:00 & 5:00 p.m.	D-236
Thursday	5:00 p.m. only	D-236

All sessions are 50 minutes- select any one weekly

APPRENTICESHIP EDUCATION



Apprenticeship Education

Enrollment in apprentice classes is limited to registered apprentices who are employed in the trade and are registered by the state. Apprenticeship students are all employed before attending classes.

The college offers related and supplemental training to apprentices who are formally registered and are employed in the industry. Under the jurisdiction of a Joint Apprentice

Committee only apprentices who have been registered by the state will be permitted to attend apprentice classes. For information concerning opportunities, please contact Mr. William (Bill) Elarton, Apprenticeship Director, in room B-122, phone (213) 763-3701 or Mr. Tom Vessella, Apprenticeship Coordinator, in room B-134A, phone (213) 763-3707.

This educational service to labor, management and government is established by the Shelley Maloney Act of 1939. Any person who is not registered and seeking information about becoming an apprentice should contact the Apprentice Information Center located at 320 West 4th Street, Suite #830, Los Angeles, CA 90013-1105. for information about the trade of interest. The phone number of the Department of Apprentice Standards is (213) 576-7750.

The apprenticeship students are all employed before attending classes. The Joint Apprenticeship Committee for each craft is listed below:

CABINET MILLWORK APPRENTICESHIP

Apply at 10015 Rose Hills Road in Whittier.
Phone (562) 699-0419 for information.

ELECTRICAL LINEMAN & ELECTRICAL CABLE SPLICER

Apply at various public utilities. Only public utilities employ line apprentices.

ENGINEER-OPERATION/ MAINTENANCE

Apply at 2501 W. Third Street, Los Angeles,
(213) 385-2889.

STATION ELECTRICIAN

Apply at Glendale Water and Power.





The Weekend College

A Program of Los Angeles Community College District

ITV The Weekend College classes allow students to complete general education classes in a focused eight-week format. Classes are taught on four campuses: **City [C]** and **Southwest [SW]** Colleges on Saturdays and **Valley [V]** and **Pierce [P]** Colleges on Sundays. First college listed is **AM only 9:00 - 12:00 Noon**. Second college listed is **PM only 1:30 - 4:30 PM**. Students may attend at any location or change locations, if necessary, throughout the semester.

The classes are taught by the same qualified LACCD instructor at each campus. Instruction is combined with award-winning video lessons available on cable television, in broadband, on DVD, and in the College Learning Resource Centers. Each class also has an online component creating a positive, engaging learning environment.

For classroom locations go to:

www.lamission.edu/itv and click View Schedule. Financial aid is available for qualified students; fee waivers apply to these classes. Transcripts are issued by LA Mission College.

Fall 2010 Session A August 30 - October 24, 2010

Classes	Section	Saturday Campus	Sunday Campus
Economics 1	7084	C/SW	P/V
English 101	7085	C/SW	P/V
Health 11	7086	C/SW	P/V
History 11	7087	C/SW	P/V
Oceanography 1	7088	SW/C	V/P
Philosophy 1	7089	SW/C	V/P
Political Science 1	7090	SW/C	V/P
Psychology 1	7091	SW/C	V/P

Saturday class meetings: September 4 – October 23

Sunday class meetings: September 5 – October 24

Last Day To:

ADD Classes: September 9, 2010

Drop without incurring fees: September 4, 2010

Summer 2010 June 14 - August 1, 2010

Classes	Section	Saturday Campus	Sunday Campus
Economics 1	7074	C/SW	P/V
English 101	7075	C/SW	P/V
Health 11	7076	C/SW	P/V
History 11	7077	C/SW	P/V
Math 125	7078	C/SW	P/V
Oceanography 1	7079	SW/C	V/P
Philosophy 1	7080	SW/C	V/P
Political Science 1	7081	SW/C	V/P
Psychology 41	7082	SW/C	V/P
Sociology 1	7083	SW/C	V/P

Saturday class meetings: June 19 – July 31

Sunday class meetings: June 20 – August 1

No class meetings: July 4 & 5

Last Day To:

ADD Classes: June 23, 2010

Drop without incurring fees: June 18, 2010

Fall 2010 Session B October 25 - December 19, 2010

Classes	Section	Saturday Campus	Sunday Campus
English 101	7092	C/SW	P/V
English 102	7093	C/SW	P/V
Health 11	7094	C/SW	P/V
History 11	7095	C/SW	P/V
Math 125	7096	SW/C	V/P
Philosophy 1	7097	SW/C	V/P
Political Science 1	7098	SW/C	V/P
Psychology 41	7099	SW/C	V/P
Sociology 1	7100	SW/C	V/P

Saturday class meetings: October 30 – December 18

Sunday class meetings: October 31 – December 19

No class meetings: November 27 & 28

Last Day To:

ADD Classes November 4, 2010

Drop without incurring fees: October 30, 2010

Website: www.lamission.edu/itv • Telephone: 818/833-3594 or 800/917-9277

STUDENT RESOLUTION PROCESS



From time to time there may be a situation where you and your instructor do not agree. To assist both of you in coming to a positive conclusion, Trade-Tech has developed an informal complaint resolution process. This process is purely optional and is not intended to replace the grievance process, however, students are urged to avail themselves of it whenever feasible.

A form is available to assist you at every level. Should you not be able to resolve a matter at one level, you are asked to bring the form with you to the next level. There are three forms: pink (Level I), green (Level II) and goldenrod (Level III). Forms are available in individual department offices, in the Academic Affairs Dean's Office (Student Services Building, 5th Floor, ST-519), and in the Compliance Office (LRC-257).

Following the informal students resolution process does not prevent you from filing an official Student Grievance through the LATTCC Compliance Officer, Dr. Letia Royal-Burnett. For more information, consult the college catalog under "Student Grievance Procedure", or visit the college website at LATTCC.edu and click on the "Compliance Office" link.

Level I (pink form)

The first step toward resolving a problem between a student and an instructor is for the two of you to meet. Most times talking it over will resolve the matter. However, if you are unable to resolve the problem between the two of you, please take a completed copy of this form to the Department Chair and discuss Step II proceedings

Level II (green form)

The second step toward resolving a problem between a student and an instructor is to schedule a meeting between the Department Chair, student and instructor. The Department Chair's role is to facilitate problem resolution by offering advice on College rules and regulations and clarifying individual responsibilities. To engage in Level II resolution, please take the pink Level I form, signed by both you and your instructor, to the Department Chair's office. A meeting will then be scheduled between you and your instructor.

Level III (goldenrod form)

The third step toward resolving a problem between a student and an instructor is to schedule a meeting with the Dean who supervises that department. To do this, you'll need to bring copies of both your Level I (pink) and Level II (green) student resolution forms with you.

COLLEGE & DISTRICT POLICIES

ACADEMIC FREEDOM

The Faculty shall have the academic freedom to seek the truth and guarantee freedom of learning to the students.

ACADEMIC STANDARDS

ACADEMIC/PROGRESS PROBATION

Students shall be placed on probation, if after attempting a minimum of 12 UNITS, any of the following occur:

1. Academic Probation: Low Grade Point Average. The student has a cumulative GPA of less than "C" (2.0).
2. Academic Probation: Transfer Student. The student has transferred with a cumulative GPA less than "C" (2.0).
3. Progress Probation. When the percentage of all UNITS attempted in which grades of "W" (withdrawal), "Inc." (incomplete), and "NC" (no credit) reaches or exceeds 50%.

ACADEMIC/PROGRESS DISMISSAL

A student on academic/ progress probation shall be DISMISSED from the College if:

1. The cumulative GPA is less than 2.0 in all UNITS attempted in each of three consecutive semesters. Or
2. If the percentage of "W", "Inc", and "NC" grades are 50% or greater in each of three consecutive semesters.

Dismissal from one college in the Los Angeles Community College District shall disqualify a student from admission to any other college in the District.

APPEAL OF DISMISSAL

A student who is subject to dismissal may appeal to the College Dismissal Committee by submitting a Return From Disqualification Petition to the College Admissions Officer in ST-Lobby. Petitions are accepted during specified time periods each semester.

ADMISSION AND RESIDENT CLASSIFICATION OF NON-CITIZENS

BOARD RULE 8100.10 Admission and Residence Classification of Non-Citizens. It is the intention of the Los Angeles Community College District that no one be discriminated against in the admission and residence classification process on the basis of national origin. Further, it is the intention of the Board that subjective personal characteristics, such as appearance and speech, not be the basis for assumptions about national origin or immigration status. The Los Angeles Community College District shall admit all non-citizens who are able to benefit from instruction and who are not barred from enrollment under Federal and/or State law. Non-citizens shall be classified as resident or nonresident in accordance with applicable State and Federal laws, California Administrative Code Title 5, and District regulations. For all terms commencing on or after January 1, 2008, all nonresidents who enroll for six UNITS or fewer shall be exempt from the nonresident tuition fee.

DIVERSITY

The policy of the Los Angeles Community College District is to implement affirmatively, equal opportunity to all qualified employees and applicants for employment without regard to race, color, national origin, ancestry, religion, creed, sex, age, handicap, marital status, medical condition (cancer related), sexual orientation, or veteran status. Positive action will be taken to ensure that

this policy is followed in all personnel practices, including recruitment, hiring, placement, upgrading, transfer, demotion, treatment during employment, rate of pay or other forms of compensation, selection for training, layoff, or termination. A vigorous Affirmative Action Program will be maintained to ensure appropriate utilization of certain protected groups in specific areas and levels within the district workforce through the implementation of specific result-oriented procedures and activities (Board Rule 101301). Inquiries regarding Affirmative Action at Los Angeles Trade-Technical College should be directed to the College Diversity Representative, Dr. Letia Royal-Burnett, Compliance Office, (213) 763-7066.

ATTENDANCE

Only students who have been admitted to the college and are in approved active status may attend classes.

Students who pre-registered in a class and miss the first meeting may lose their right to a place in the class. Students should attend every meeting of all classes for which they register. To avoid being dropped from class, students should contact the instructor when they are absent for emergency reasons.

Students are responsible for dropping a class that they stop attending. If the class is not dropped, the student may receive an "F" in that class and be responsible for enrollment fee. Any drops or exclusions that occur between the end of the 4th week and the end of the 12th week will result in a "W" on the student's record which will be included in the determination of progress probation. Drops are not permitted beyond the end of the 12th week. An evaluative grade ("A", "B", "C", "D", "F", "CR", or "NC") will be assigned to students who are enrolled past the end of the 12th week even if they stop attending class, except in cases of extreme extenuating circumstances.

CONDUCT EXPECTED OF STUDENTS

Students enrolling in one of the Los Angeles Community Colleges may rightfully expect that the faculty and administrators will maintain an environment in which there is freedom to learn. This requires that there be appropriate conditions and opportunities in the classroom and on the campus. As members of the college community, students should be encouraged to develop the capacity for critical judgment; to engage in sustained and independent search for truth; and to exercise their rights to free inquiry and free speech in a responsible, nonviolent manner. Students shall respect and obey civil and criminal law, and shall be subject to legal penalties for violation of laws of the City, County, State, and Nation.

CLASSROOM CONDUCT

Instructors are responsible for presenting appropriate material in courses, and students are responsible for learning this material. Although it is a student's academic performance that is evaluated in determining grades, student conduct is important in the academic setting. Enrollment in a class may be terminated due to unsatisfactory student conduct, undue disrespect toward an instructor or administrator, or academic dishonesty. Each student is responsible for maintaining standards of academic performance established for each course in which he or she is enrolled.

BE ON TIME

Students are expected to attend and arrive on time for each class meeting. Class time is limited; students learn more and understand important concepts better if they always come on time for each class session.

RESPONSIBILITY TO BE INFORMED

It is the student's responsibility to read the information presented in this schedule and to know and observe all policies and procedures related to his/her program. Regulations will not be waived nor exceptions granted because a student pleads ignorance of policies, procedures, or deadlines.

PASS/NO PASS

Students may complete a request form to take a class on a Pass/No Pass basis through the sixth week of the semester. For Summer and Winter Semesters, through the second week. Courses, which students may elect to take on a Pass/No Pass basis, are listed in the college catalog. Request forms may be obtained at the Admissions Office, ST-Lobby.

The grade of P (pass) will be given if the performance in class is equal to a "C" grade or better.

The grade of NP (no pass) will be given if the performance in class is equal to a "D" or "FAIL" grade.

A student who has received credit for a course taken on Pass/No Pass basis may not convert this credit to a letter grade.

DRUG-FREE WORKPLACE POLICY

Los Angeles Trade-Technical College adheres to, supports, and is in full compliance with requirements that maintain our college as a drug-free institution of higher education.

The LACCD Board of Trustees has adopted the following standards of conduct:

- Students and employees are prohibited from unlawfully possessing, using or distributing illicit drugs and alcohol on district premises, in District vehicles, or as part of any activity of the Los Angeles Community College District.

The LACCD Board of Trustees has adopted Rule 9803.19, which prohibits:

- Any possession of controlled substances which would constitute a violation of Health and Safety Code section 11350 or Business and Professions Code section 4230, any use of controlled substances, the possession of which is prohibited by the same or any possession or use of alcoholic beverages while on any property owned or used by the District or colleges of the District. "Controlled substances," as used in this section, include, but are not limited to the following drugs and narcotics: opiates, opium and opium derivatives, mescaline, hallucinogenic substances, peyote, marijuana, stimulants, depressants, cocaine.

E-MAIL ACCOUNT FOR ENROLLED STUDENTS

Student e-mail accounts are created approximately 2 weeks after a student is enrolled in a class. To learn about your e-mail account, find the link on the campus home page to MyLATTTC Portal and click on it. That will redirect you to the web page with the directions and a tutorial video. Your login id is your student ID number and your password is the six numbers that represent mmddyy of your date of birth. You can create a nickname that will provide an alias for receiving email. However, you always log in using your student ID number.

EDUCATIONAL ENVIRONMENT POLICY

Due to requirement set forth by the Occupational Safety and Health Administration, proper attire, including shoes, eye ware, and other articles, should be worn during all class hours.

EMERGENCY INFORMATION

The College is concerned about your safety in case of an emergency. Detailed instructions are posted in every classroom and throughout the campus. Take a few minutes to read them and plan for your safety.

FAMILY EDUCATION RIGHTS AND PRIVACY ACT (FERPA)

See Student Records and Directory Information. For more information on student rights under the FERPA, please go to our LA Community College homepage http://www.laccd.edu/admin_regs/.

FEE EXEMPTION FOR SPECIAL PART-TIME & FULL-TIME STUDENTS GRADES K-12

Commencing with the Spring 2002 semester, non-resident students who are admitted as "Special Part-Time & Full-Time Students Grades K-12 under the Board Rule 8100.05 are also exempted from paying non-resident tuition for all semesters and terms including Summer and Winter Intersession. Please see Admissions & Records Office, ST-Lobby, for details.

FREEDOM OF SPEECH AREA AND PROCEDURES

BOARD RULE 9902. Article IX, states, "The college president shall designate an area or areas on the college campus as areas for free discussion and expression by all persons. A Free Speech Area may only be located where there is a normal flow of student traffic with unlimited accessibility. Necessary campus rules governing the operation of such areas shall govern only the time, place and manner in which said areas are to be used. All such rules shall be applied equally and fairly to all persons desiring to use the Free Speech Areas. No restrictions shall be placed on subject matter, topics or viewpoints expressed in Free Speech Areas.

In compliance with the above Board Rule, the college president has designated the K-Mall Quad as the Free Speech Area. All individuals or organizations wanting to use the Free Speech Area, must check into the Vice President of Student Services office, located in ST-514, prior to use of this area. The guidelines and rules for use of this area, along with time, place and manner will be distributed to the interested party. This procedure does not apply to activities sponsored by the college.

GRADES AND GRADE CHANGES

The instructor of the course shall determine the grade to be awarded to each student in accordance with the college's Grading Symbols and Definitions Policy. The determination of the student's grade by the instructor is final in the absence of mistake, fraud, bad faith or incompetence. The removal or change of an incorrect grade from a student's record shall only be done upon authorization by the instructor of the course.

Students may file a petition for grade change in the Admissions and Records office. Grade change Petitions must be submitted within a year after the grade was assigned. In the case of fraud, bad faith or incompetence, the final determination concerning removal or change of grade will be made by the College President.

GRADE REQUEST AND NOTIFICATION

Students can access their grade information through the Student Telephone Enrollment Process (STEP) by following the steps below:

1. Dial one of the following numbers: (213) 689-8888; (310) 605- 0505; (818) 988-2222; (323) 226-1999. STEP's voice response will guide you with each entry. Press * to correct any mistakes.
2. Press 7 for Los Angeles Trade-Technical College
3. Press 0 for Winter, 1 for Spring, 2 for Summer, or 3 for the Fall semester
4. Enter your Student ID Number
5. Enter your Personal Identification Number (PIN) (four digits number of your birthday)

6. Press 3 to hear your grades
7. Press 3 to exit the system

If you need a copy of your grades, you can obtain a grade printout from the web. This printout is NOT a Transcript or a Verification of Enrollment. If you need an Official Transcript or a Verification of Enrollment, you may order them from the Admission Office, ST-Lobby.

INCOMPLETE

A grade of "Inc" (incomplete) may be made up no later than ONE YEAR following the end of the term in which it was assigned by making personal arrangements with the instructor. If the Incomplete is not made up by the deadline, THE INCOMPLETE WILL BE REMOVED AND REPLACED BY A GRADE DETERMINED BY THE INSTRUCTOR. A CLASS MAY NOT BE REPEATED TO CLEAR AN INCOMPLETE GRADE.

GRADUATION

Please refer to the current College catalog for specific graduation requirements.

GRADUATION APPLICATION FOR DEGREES/CERTIFICATES

All students must file an application for degree/certificate evaluation during the first 6 weeks of the semester in which they expect to complete their degree/ certificate requirements. Students completing the course work during the Summer Session must file an application during the first 6 weeks of the preceding Spring Semester. Late applications are not accepted. Applications are available in the Admissions and Records Office, ST-Lobby.

The following requirements apply to students entering for the first time after July 2, 1983. Continuing students with uninterrupted attendance and demonstrating satisfactory progress, exclusive of summer session, should refer to the College Catalog in effect at the time of their initial enrollment. A continuing student is one who has completed a minimum of one course per semester, except that completion with a "W" will be accepted for one semester only.

Prior to the end of the semester in which the application is filed, students will be notified by mail of their degree/certificate evaluation.

Students who do not complete requirements must submit a new application during the first 6 weeks of the semester in which they expect to meet requirements. Students successfully completing all requirements will be NOTIFIED THROUGH U.S. MAIL when their degree/certificate is ready for pick-up, based on the following schedule:

- Students completing all requirements by the end of the Fall Semester will have the degree/certificate ready after June 15.
- Students completing all requirements by the end of the Spring Semester will have degree/certificate ready after August 15.
- Students completing all requirements by the end of Summer Session will have degree/certificate ready after September 15.

Students Must Present The Notification Card And Proper Photo Identification When Picking-up Degree/ Certificate. Diplomas and/or Certificates will be held for only one year after the Diploma/Certificate graduation date. Qualified graduates who do not pick-up their Diploma/Certificate within the above time frame must submit a request for a duplicate Diploma/ Certificate and will be assessed a fee for duplicate preparation.

HOPE SCHOLARSHIP TAX CREDIT

According to federal tax credit legislation, students who are enrolled at least half-time (6 or more UNITS) on census day and who have paid enrollment fees may be able to deduct their enrollment fees on their federal income tax. For more information and the necessary forms, go to the Admissions Office (ST-Lobby), the Business Office (ST-109) or Financial Aid Office (ST-214) and ask for IRS form W-9.

LIMITED ENGLISH PROFICIENCY

Occupational education classes are open to all students. The lack of proficiency in English is no barrier to enrollment in occupational educational courses, although the college suggests that students who are deficient in English use the services of the college that we provide for persons who are limited in English proficient or speak English as a second language.

ESTUDIANTES CON FALTA DE COMPETENCIA EN LENGUA INGLESA

Los cursos relacionados con la educación para carreras intermedias u ocupacionales gozan de disponibilidad para todos los estudiantes. La falta de competencia en lengua inglesa no constituye barrera alguna para poder inscribirse en dichos cursos. Por otro lado, el plantel les sugiere a aquéllos que aún no dominan el inglés que hagan uso de los servicios que la institución les ofrece a tales personas.

英语能力有限的学生

学校的职业訓練課程是开放給所有学生。英语能力有限的学生注册职业課是不受任何限制。本校建议学生使用我们所提供的雙语服务。

NONDISCRIMINATION POLICY

All programs and activities of the Los Angeles Community College District shall be operated in a manner which is free of discrimination on the basis of race, color, gender, national origin, ancestry, religion, creed, pregnancy, marital status, medical condition (cancer related), gender orientation, age, disability, or veteran status (Reference: Board Rule 1202). Inquiries regarding Affirmative Action issues should be directed to Dr. Letia Royal-Burnett, (213) 763-7066. Inquiries relating to disabilities and special accommodations per the Americans with Disabilities Act should be directed to Ms. Donna Lichtman, Director of Disabled Students Programs and Services, (213) 763-3773 & TDD (Telecommunications Device for the Deaf) (213) 763-5375.

NORMAS DEL PLANTEL REFERENTES A LA DISCRIMINACIÓN

Todos los programas y actividades de Los Angeles Community College District se llevan a cabo libres de cualquier tipo de discriminación racial o de discriminación referente al color, género, nacionalidad, ascendencia, religión, credo, feñez, estado matrimonial, condición médica (con relación al cáncer), orientación sexual, edad, discapacidad, veteranía de las fuerzas armadas (Referencia: Board Rule 1202). Toda averiguación concerniente a Affirmative Action (Acción afirmativa) deberá dirigirse a Dr. Letia Royal-Burnett, (213) 763-7066. Averiguaciones concernientes a la discapacidad y acomodo especial referente a las normas de Americans with Disabilities Act (Ley de discapacidad de los Americanos) deberán dirigirse a Donna Lichtman, Directora del programa y servicios para estudiantes discapacitados, (213) 763-3773. Personas sordomudas, por favor, dirigirse al teléfono (213) 763-5375.

免于歧视政策

洛杉矶公立大学学区政策的所有課程和活动是免于歧视种族, 肤色, 性别, 国籍, 血缘, 宗教, 信仰, 怀孕, 婚姻, 健康癌症, 性向, 年龄, 伤残, 或 退伍军人状态 (委员会规则 120 询问有关平权法 (Affirmative Action) 請聯絡 Dr. Letia Roy Burnett, (213) 763-7066. 问有关伤残和特别膳宿供应与美国残法案, 請聯絡 Donna Lichtman 女士, 残疾学生服务主 (213) 763-3773 & TDD (聋人电信设备)(213) 763-5375.

OPEN ENROLLMENT

Unless specifically exempted by law, every course for which State Aid is claimed is fully open to any person who has been admitted to the college and who meets the appropriate recommended academic prerequisites.

PARKING ON CAMPUS

The parking information contained in the Schedule of Classes is intended to provide individuals with basic guidelines on the College's parking program, rules, regulations, and enforcement policies. For the complete text of this information, please refer to the current College catalog. This information may also be obtained from the College Sheriff's Department, D-150, the Administrative Projects Office, ST-532, or the College website (www.lattc.ca.us/html/Parking-Info.htm).

PARKING GUIDELINES

All parking is by valid College permit only. Parking permits are made of removable mylar and should be affixed to the inside of the rear window (right side). Parking permits must be displayed at all times a vehicle is parked on campus, weekends included. The purchase of a parking permit does not guarantee a specific parking space; it is only a license to park one vehicle in designated parking lots as posted at the entrance of each parking lot.

Student parking permits are available for purchase at the Business Office for \$20 per permit per semester for Spring and Fall.

A valid college parking permit and a DMV placard must be displayed on any vehicle parked in a designated handicapped stall. Students with a verified disability should go to the Disabled Students Program and Services Office, E-110, to arrange for an accommodation.

STUDENT PARKING PERMIT SALES, REFUNDS AND EXCHANGES

Inquiries regarding the College's parking should be directed to the following offices during normal business hours: Parking Rules, Regulations, Permit Use, and Enforcement: College Sheriff's Department, D-150, (213) 763-3600 Permit Sales, Refunds, and Exchanges: Business Office, ST-Lobby, (213) 763-7225. College Sheriff's Department personnel are on duty 24 hours a day, seven days a week to assist with permit use and enforcement issues.

TRANSPORTATION

The college is located near the intersection of the Harbor and Santa Monica freeways, and is directly across the street from the Metro Blue Line's Grand Avenue station. In addition to the light rail system, there are more than 40 bus lines stopping at or within two blocks of the College. For more information, please consult the College website at www.LATTC.edu.

SEXUAL ASSAULT

The policy of the Los Angeles Community College District is committed to providing a safe environment for its students, faculty, and staff. The Los Angeles Community College District Board of Trustees condemns any act of sexual assault committed on any of its facilities. In the event of sexual assault committed on grounds or in facilities maintained and/or used by the District, any victim of a sexual assault who is one of the District's students, faculty, staff, or visitors shall promptly receive appropriate treatment and full and accurate information. Individuals who commit sexual assault while on properties within the control of the District shall be subject to appropriate criminal prosecution and/or District disciplinary procedures.

Confidentiality is fundamental to all aspects of cases dealing with sexual assault. The names of sexual assault victims shall not be revealed by persons responsible for implementing and enforcing the provision of this Chapter, except with the consent of the victim. College Sheriff's Department, (213) 763-3611, Building D-150.

Please contact Letia Royal-Burnett on 213-763-7066 for information about making a complaint of unlawful discrimination or harassment

SMOKING/NON-SMOKING POLICY

Smoking is not permitted in any classroom or other enclosed facility or adjacent entrances and exits, porches, decks and stairwells. Smoking is permitted only in designated areas

SOCIAL SECURITY NUMBERS/STUDENT IDENTIFICATION NUMBER

Effective July 24, 2006, Los Angeles Community College District will no longer use the social security number as a student identifier. State Law requires the college district to issue a separate student identification number to identify students which will help protect the confidentiality of students' social security numbers. However, for financial aid purposes, social security numbers will be required.

STANDARDS OF STUDENT CONDUCT

A student enrolling in one of the Los Angeles Community Colleges may rightfully expect an environment in which there is freedom to learn. This in turn requires that there be appropriate conditions in the classroom and on the campus. To this end, all persons shall respect and obey civil and criminal law, and shall be subject to legal penalties for violation of laws of the city, county, state and nation. All visitors making use of the facilities or grounds of any college of the District will be expected to abide by the Standards of Conduct and the rules relating to campus visitors adopted by the Board of Trustees. Violations of all such rules and regulations, may result in disciplinary action depending on the individual's status as student, faculty, staff or visitor. Violations of rules and regulations include but are not limited to the following:

BOARD RULE 6201.12: Competency Requirement. Students entering prior to Fall 2009 must demonstrate competence in reading, in written expression, and in mathematics. This requirement may be met by achieving a grade of "C" or better in appropriate courses, recommended by the District Academic Senate, and approved by the Chancellor or by achieving a passing score on an examination or examinations recommended by the District Academic Senate and approved by the Chancellor.

Effective for all students entering on or after the Fall 2009 semester, competence in written expression shall be demonstrated by obtaining in satisfactory grade in English 101, or another English course at the same level and with the same rigor as recommended by the District Academic Senate and approved by the Chancellor. Competence in mathematics shall be demonstrated by obtaining a satisfactory grade in Mathematics 125 (Intermediate Algebra), or another mathematics course at the same level and rigor, or higher, and with elementary algebra or higher as a prerequisite, as recommended by the District Academic Senate and approved by the Chancellor.

The competency requirements in written expression or mathematics may also be met by completing an assessment, conducted pursuant to Title 5, CCR, section 55500 and achieving a score determined to be comparable to satisfactory completion of English 101 or Mathematics 125 respectively. That is, students may either place into English or mathematics courses above level of English 101 or Mathematics 125, or they may achieve a satisfactory score on a competency exam or other approved exam as recommended by the District Academic Senate and approved by the Chancellor.

The competency requirements may also be met by obtaining a satisfactory grade in courses with English and mathematics content (but taught in subjects other than English and mathematics), which require entrance skills at a level equivalent to those necessary for English 101 and Mathematics 125, respectively, and are taught at the same level and with the same rigor. The District Academic Senate shall recommend such courses to the Chancellor for approval.

BOARD RULE 6202: CATALOG RIGHTS: For these purposes, a catalog year is defined as beginning fall semester and continuing through the proceeding summer. A Student remaining in College District may elect to satisfy the degree, certificate or graduation requirements in effect at the college from which the student will either earn his/her degree, certificate or graduate:

1. At the time the student began such attendance at the college, or
2. at the time of graduation.

For the purposes of implementing this policy, the college may develop a policy to:

1. authorize or require substitutions for discontinued courses; or
2. require a student changing his/her major to complete the major requirements in effect at the time of the change;
3. allow students to select an intervening catalog in years between time student began continuous attendance and time of graduation.

The college's policy shall be developed in consultation with the college Academic Senate in accordance with the provisions of Chapter XVIII of the Board Rules - ACADEMIC SENATE AND THE BOARD OF TRUSTEES SHARED GOVERNANCE POLICY, and published in all college catalogs under appropriate headings.

This policy does not apply to college programs which are governed or regulated by outside government agencies or which require licensure or certification through one of these agencies.

BOARD RULE 6703.11: Acceptance of Credits.

All courses and UNITS used to satisfy LACCD curriculum requirements, including graduation requirements (Chapter VI, Article II, LACCD Board Rules), educational program requirements (Board Rule 6708) and transfer core curriculum requirements (Board Rule 6600), shall be from accredited institutions, unless otherwise specified in this Board Rule.

For purposes of this Board Rule, "accredited institution" shall mean a postsecondary institution accredited by an accreditation agency recognized by either the U.S. Department of Education or the Council on Postsecondary Accreditation. It shall not mean an institution "approved" by the California Department of Education or by the California Council for Private Postsecondary and Vocational Education.

Courses accepted, which have a grade of "C-" do not satisfy any LACCD curriculum requirement that requires a grade of "C" or higher.

BOARD RULE 6703.17: Remedial Coursework Limit.

- a. A student's need for remedial coursework shall be determined using appropriate assessment instruments, methods, or procedures administered pursuant to Title 5, CCR, subchapter 6 (commencing with section 55500). However, except as provided in subdivision (c) of this Board Rule, no student shall receive more than 30 semester UNITS of credit for remedial coursework. Students having exhausted the unit limitation shall be referred for further remedial work to appropriate noncredit courses provided by a college, adult school, community-based organization, or other appropriate local provider.
- b. For the purpose of this section, "remedial coursework" refers to nondegree-applicable basic skills courses as defined in Title 5, CCR, of section 55500.
- c. The following students are exempted from the limitation on remedial coursework described in subdivision (a) of this Board Rule: (1) Students enrolled in one or more courses of English as a Second Language (ESL); (2) Students identified by the district as having a learning disability as defined in section 56036.
- d. Colleges may provide a waiver of the limitation on remedial coursework with respect to any student who shows significant, measurable progress toward the development of skills appropriate to his or her enrollment in degree-applicable credit courses. Each college, in consultation with its Academic Senate, shall develop procedures for determining whether a student has "significant, measurable progress toward the development of skill appropriate to his or her enrollment. Such procedures shall take

into account the student's course taking pattern, grades, and intra and inter-semester persistence. Such waivers will only be granted for specified periods of time or for specified numbers of UNITS.

- e. A student who does not attain full eligibility status for degree-applicable credit courses within the limit described in subdivision (a) of this section shall, unless provided with a waiver, be restricted to taking only noncredit courses, nondegree-applicable courses which do not involve remediation, and those degree-applicable credit courses which do not have basic skills prerequisites or advisories on recommended preparation.
- f. A student may, upon successful completion of appropriate "remedial coursework," or upon demonstration of skills levels which will reasonably assure success in degree-applicable credit courses, request reinstatement to proceed with such coursework.

BOARD RULE 9803.10: Willful Disobedience. Willful disobedience to directions of College officials acting in the performance of their duties.

BOARD RULE 9803.11: Violation of College Rules and Regulations. Violation of College rules and regulations, including those concerning student organizations, the use of College facilities, or the time, place, and manner of public expression or distribution of materials.

BOARD RULE 9803.12: Dishonesty. Dishonesty, such as cheating, or knowingly furnishing false information to the colleges.

BOARD RULE 9803.13: Unauthorized Entry. Unauthorized entry to or use of the college facilities.

BOARD RULE 9803.14: College Documents. Forgery, alteration, or misuse of college documents, records, or identification.

BOARD RULE 9803.15: Disruption of Classes. Obstruction or disruption of classes, administration, disciplinary procedures, or authorized college activities.

BOARD RULE 9803.16: Theft of or Damage to Property. Theft of or damage to property belonging to the college, a member of the college community, or a campus visitor.

BOARD RULE 9803.17: Interference With Peace of College. The malicious or willful disturbance of the peace or quiet of any of the Los Angeles Community Colleges by loud or unusual noise, or any threat, challenge to fight, fight, or violation of any rules of conduct as set forth in this Article. Any person whose conduct violates this section shall be considered to have interfered with the peaceful conduct of the activities of the college where such acts are committed.

BOARD RULE 9803.18: Assault or Battery. Assault or battery, abuse or any threat of force or violence directed toward any member of the college community or campus visitor engaged in authorized activities.

BOARD RULE 9803.19: Alcohol and Drugs. Any possession of controlled substance which would constitute a violation of Health and Safety Code section 11350 or Business and Professions Code section 4230, any use of controlled substances the possession of which are prohibited by the same, or any possession or use of alcoholic beverages while on any property owned or used by the District or colleges of the District. "Controlled substances," as used in this section, include but are not limited to the following drugs and narcotics:

- a. opiates, opium and opium derivatives
- b. mescaline
- c. hallucinogenic substances
- d. peyote
- e. marijuana
- f. stimulants and depressants
- g. cocaine

BOARD RULE 9803.20: Lethal Weapons. Possession, while on a college campus or at a college-sponsored function, of any object that might be used as a lethal weapon is forbidden all persons except sworn peace officers, police officers, Sheriff, and other governmental employees charged with policing responsibilities.

BOARD RULE 9803.21: Discriminatory Behavior. Behavior while on a college campus or at a college-sponsored function, inconsistent with the District's non-discrimination policy, which requires that all programs and activities of the Los Angeles Community College District be operated in a manner which is free of discrimination on the basis of race, color, national origin, ancestry, religion, creed, sex, pregnancy, marital status, sexual orientation, age, handicap or veterans status.

BOARD RULE 9803.22: Unlawful Assembly. Any assemblage of two or more persons to 1) do an unlawful act, or 2) do a lawful act in a violent, boisterous or tumultuous manner.

BOARD RULE 9803.23: Conspiring to Perform Illegal Acts. Any agreement between two or more persons to perform illegal acts.

BOARD RULE 9804: Interference with classes. Every person who, by physical force, willfully obstructs, or attempts to obstruct, any student or teacher seeking to attend or instruct classes at any of the campuses or facilities owned, controlled or administered by the Board of Trustees of the Los Angeles Community College District, is punishable by a fine not exceeding five hundred dollars (\$500) or imprisonment in a county jail not exceeding one year, or both such fine and imprisonment. As used in this section, "physical force" includes, but is not limited to, use of one's person, individually or in concert with other, to impede access to or movement within or otherwise to obstruct the students or teachers of the classes to which the premises are devoted.

BOARD RULE 9805: Interference with performance of duties of employees. Every person who attempts to cause, or causes, any officer or employee of any of the Los Angeles Community Colleges or any public officer or employee to do or refrain from doing, any act in the performance of his/her duties, by means of a threat to inflict any injury upon any person or property, is guilty of a public offense.

BOARD RULE 9805.10: Assault or abuse of Instructor. Every parent, guardian, or other person who assaults or abuses any instructor employed by the District in the presence or hearing of a community college student or in the presence of other community college personnel or students and at a place which is on District premises or public sidewalks, streets, or other public ways adjacent to school premises, or at some other place where the instructor is required to be in connection with assigned college activities is guilty of a misdemeanor.

BOARD RULE 9806: Unsafe Conduct. Conduct which poses a threat of harm to the individual and/or to others. This includes, but is not limited to, the following types of conduct: Unsafe conduct in connection with a Health Services Program (e.g., Nursing, Dental Hygiene, etc.); failure to follow safety direction of District and/or college staff; willful disregard to safety rules as adopted by the District and/or college; negligent behavior which creates an unsafe environment.

DISCIPLINARY ACTION

Community college districts are required by law to adopt standards of student conduct along with applicable penalties for violation. The Los Angeles Community College District has complied with this requirement by adopting Board Rule 9803, Standards of Student Conduct (See above). Board Rule 9804, Student Discipline Procedures, provides uniform procedures to assure due process when a student is charged with a violation of the Standards

of Student Conduct. Disciplinary measures may be taken by the College independently of any charges filed through civil or criminal authorities, or both. Copies of the Student Discipline Procedures are available in the Vice President of Student Services Office, ST-514, (213) 763-7078.

STUDENT GRIEVANCE PROCEDURES

The purpose of the Student Grievance Procedures is to provide a prompt and equitable means for resolving student grievances. The procedures enumerated in Administrative Regulation E-55 shall be available to any student or applicant for admission, who believes a College decision or action has adversely affected his or her status, rights, and/or privileges as a student. The procedures shall include, but not be limited to, alleged violations of Title IX of the Higher Education Amendments of 1972 (and applicable regulations), grievances relating to disabled students as defined by Section 504 of the Rehabilitation Act of 1973, and grievances relating to course grades to the extent permitted by Education Code Section 76224(a). Section 76224(a) provides:

"When grades are given for any course of instruction taught in a community college district, the grade given to each student shall be the grade determined by the instructor of the course and the determination of the student's grade by the instructor, in the absence of mistake, fraud, bad faith, or incompetence, shall be final." For additional information, contact the college Ombudsperson at (213) 763-7066.

OMBUDSPERSON

Pursuant to the Student Grievance Procedure, the College Ombudsperson has been appointed by the President to assist the student in obtaining informal resolution of his or her grievance. If an informal resolution is not obtained, then the Ombudsperson will arrange for the formation of a Grievance Hearing Committee to hear the student's grievance and will facilitate the hearing process pursuant to District Administrative Regulation E-55. The Compliance Officer may be contacted at (213) 763-7066.

STUDENT RECORDS AND DIRECTORY INFORMATION

The Los Angeles Community College District, in compliance with Federal and State law, has established policies and procedures governing student records and the control of personally identifiable information. The Los Angeles Community College District recognizes that student records are a confidential matter between the individual student and the College. At the same time the District has a responsibility to fulfill public information needs (i.e., information about students participating in athletics, announcement of scholarships and awards, etc.). To meet this responsibility the District may release Directory Information unless the student states in writing that he or she does not want it released. The responsibility for carrying out these provisions is charged to the College Records Officer, designated by the chief administrative officer on each campus. The Records Officer may be contacted via the Office of Admissions. Copies of Federal and State laws and District policies and procedures are maintained by the Records Officer and are available for inspection and inquiry. No information may be given via telephone request.

All student records maintained by the various offices and departments of the College, other than those specifically exempted by law, are open to inspection by the student concerned. The accuracy and appropriateness of the records may be challenged in writing to the Records Officer. A student has the right to receive a copy of his or her record, at a cost not to exceed the cost of reproduction. (Requests for transcripts should be made directly to the Office of Admissions).

No student records, including Directory Information, will be released without the written consent of the student concerned except as authorized by law. A log of persons and organizations requesting or receiving student record information is maintained by the Records Officer. The log is open to inspection only to the student and the community college official or his or her designee responsible for the maintenance of student records.

Directory Information includes the student's name, city of residence, participation in officially recognized activities and sports, weight and height of members of athletic teams, dates of attendance, degrees and awards received, and the most recent previous educational agency or institution attended by the student. This information will not be released to anyone if the student marks "NO" on question #28 on the College Application or if the student marks "NO" on the College's Release of Directory Information form. This form is available in the Admission Office, ST-Lobby.

In addition, under federal law, the military is entitled to receive the following student information for recruitment purposes: student directory information as defined above, student address, telephone number, date and place of birth, and major field of study. This information will not be released to the military if the student marks "NO" on question #28 on the College Application or if the student marks "NO" on the College's Release of Directory Information form.

All inquiries regarding student records, Directory Information, and policies for records access, release, and challenge should be directed to the Records Officer via the Office of Admissions. Students have the right to file a complaint with the United States Department of Education concerning alleged violations of Federal and State laws governing student records.

STUDENT RIGHTS AND RESPONSIBILITIES

All students are urged to carefully read the General Information section of the College Catalog. It is the utmost importance that you understand the Standards of Student Conduct as outlined in the Catalog.

STUDENT RIGHT TO KNOW

GRADUATION RATES

In compliance with the Student-Right-to-Know and Campus Security Act of 1990, the graduation rate of full-time, certificate or degree seeking students who entered in the Fall 1999 semester and graduated no later than academic year 2001-2002 is 21.6%; the Transfer rate is 35.1%

More information about Student Right-to-Know Rates can be found at the California Community Colleges "Students Right-to-Know Rates Information Clearinghouse Website" located at <http://srtk.cccco.edu>.

CRIME REPORTING PROCEDURES

Safety at Los Angeles Trade-Technical College is everybody's concern. The Los Angeles Community College District maintains a Sheriff's Department in operation 24 hours a day. Any criminal activity can be reported at any time of day or night by calling extension (213) 763-3611 from any college phone or *80 from any pay phone. The college Sheriff's Department office is located in D-150, on the northwest corner of 21st Street and Grand Avenue.

CAMPUS SECURITY ACT-THE CLEARY ACT (ANNUAL REPORTS)

Los Angeles Trade-Technical College, in compliance with the Federal Student Right to Know and Campus Security Act of 1990, provides the campus crime statistics for three calendar years. Listed on next page are the campus crime statistics for 2007, 2008, and 2009 calendar years.

The College Security Report is also posted at the College Sheriff's office website which can be accessed through the web address: <http://college.lattc.edu/sheriff/crime-statistics>. A paper copy of the report is also available upon request at the college Sheriff's office. D150.

Offences Reported	Occurrences		
	Year January 1 to December 31	2009	2008
ARREST	38	51	44
ASSAULTS	11	3	15
AUTO BURGLARIES	15	12	14
BURGLARIES	36	16	12
GRAFFITI /VANDALISM	10	19	44
GRAND THEFT	22	36	25
GRAND THEFT AUTO	9	2	5
LIQUOR LAW VIOLATIONS	0	2	3
MARIJUANA POSSESSION DETENTIONS	14	28	18
MURDERS	0	0	0
MANSLAUGHTER	0	0	0
NARCOTICS VIOLATIONS	14	28	18
PETTY THEFTS	84	70	73
RAPE	0	0	0
SEXUAL BATTERY	1	0	0
ROBBERIES	1	2	7
WEAPON VIOLATIONS	3	1	1
MISCELLANEOUS REPORTS	72	52	56

TRANSCRIPTS

Transcripts are available to students upon written request. Transcript Request Forms are available in the Admissions Office (ST-102). District policy prohibits the acceptance of Transcript Requests over the phone. Please consult the Admissions and Records Office for fees and time schedules for delivery.

VERIFICATIONS OF ENROLLMENT

Verification of the Student's Enrollment may be obtained upon written request. Verification Request Forms are available in the Admissions Office (ST-102). District policy prohibits the acceptance of Verification Requests over the phone. Please allow ten (10) working days for processing. Requests for Verification of Enrollment by Agencies or Individuals other than the student must be accompanied by a signed release.

VIEWING YOUR RECORDS

Under the provisions of the Family Education Rights and Privacy Act of 1974 students may see their records by making an appointment with a counselor for this purpose.

CAMPUS OFFICES & SERVICES

ADMISSION AND RECORDS

(213) 763-5300

Location: Student Services Building, ST-Lobby

The Admissions and Records Office is located in Building "R", Room 102. Office hours are Monday to Thursday 8:30 a.m. to 7:00 p.m. and Friday 8:30 a.m. to 3:00 p.m. Services include admission to the college, registration, maintenance and protection of students' records, receiving and processing grade rosters and other related documents, evaluation of certificates and graduation applications, processing transcripts and petitions, and verifying student enrollment. We also provide service to Veteran students.

BRIDGES TO SUCCESS CENTER

(213) 763-5560

(213) 763-5661 En Español

Location: Student Services Building, ST-316

E-mail: bridge@latc.edu

The Bridges to Success Center is a gateway to college for those students that are still enrolled in K-12 grades, wish to take noncredit and continuing education, adult students who had not considered college before and immigrants/second language learners. We help students earn their high school diplomas and GEDs, start college early, enter short-term career training that prepares them for high demand careers, strengthen their basic academic skills and prepare them to successfully enter the workplace. We are a one-stop center that provides our students with high-touch services to make their transition to college a smooth one.

CAREER CENTER

(213) 763-7104

Location: C-107A

The Career Center's mission is to promote effective career counseling and planning. Experienced staff assist students with career options and provide career assessments, interpretations, guidance and assist students with developing career objectives and educational opportunities. Hours are: Monday – Tuesday, 10:00 a.m. – 3:30 p.m., Wednesday, 9:00 a.m. – 3:00 p.m., Thursday, 9:00 a.m. – 1:00 p.m.

CHILD DEVELOPMENT CENTER

(213) 763-3690

Location: Corner of Olive & 21st

The Campus Child Development Center provides free or low cost childcare to eligible parents who attend classes, job training, and/or are working. The Center serves children between the ages of 12 months and 5 years old, Hours are from 6:30 a.m. to 5:00 p.m., Monday through Thursday, 4:00 p.m. on Friday. Evening childcare is available for children between 5 and 12 years of age from 4:30 p.m. to 9:30 p.m., Monday through Thursday.*

* *Services subject to change*

COOPERATIVE AGENCIES RESOURCES FOR EDUCATION (C.A.R.E.)

(213) 763-7117

Location: Student Services Building, ST-205

The CARE is a special program for a unique group of EOPS students. The CARE program provides additional services to students who are single parents, head-of-household, receive public assistance (AFDC) and have at least one child age 14 or younger. Hours are Monday-Thursday: 8:00 a.m. – 7:00 p.m., Fridays: 8:00 a.m. – 4:00 p.m.

COUNSELING SERVICES

(213) 763-7354

Location: Student Services Building, ST-416

Counselors are available to provide academic, vocational, personal, and support services to students. It is recommended that students who have attended other colleges bring copies of transcripts from those colleges for review. Counseling Center hours: 8:00 a.m. – 6:30 p.m., Monday through Thursday & 8:00 a.m. – 3:00 p.m., Friday. Appointments are available beginning the first week of each term.

DISABLED STUDENT PROGRAM & SERVICES (DSP&S)

(213) 763-3773

Location: E-110

The Disabled Student Services Program provides specialized counseling, priority registration, parking (with medical verification). With documentation, arrangements will be made for interpreters, test proctoring, note-taking, tutoring, and other services. Office hours are Monday through Thursday, 8:30 a.m. – 4:30 p.m.

*** ATTENTION DISABLED PLACARD HOLDERS ONLY****

If the elevator for the F building is not functioning. You may call the Sheriff's Office for an escort. Please call 213-763-3600 or you may also use the emergency blue phone next to the elevator.

EXTENDED OPPORTUNITY PROGRAM AND SERVICES (EOPS)

(213) 763-7097/7117

Location: Student Services Building, ST-205

Extended Opportunity Program and Services (EOPS) is designed to supplement existing college programs and to provide assistance to aid financially and educationally disadvantaged full-time students. EOPS services include counseling (academic, career, personal); priority registration; tutoring, personal development courses and assistance with books and supplies. Hours are Monday through Thursday, 8:00 a.m. to 4:00 p.m.; Friday: 8:00 a.m. to 4 p.m.

FINANCIAL AID SERVICES

(213) 763-7082

Location: Student Services Building ST-214

Los Angeles Trade-Technical College offers federal and state financial aid to applicants who demonstrate that they can meet only a fraction of the cost required to attend college. Trade-Tech offers the following programs:

- Federal Pell Grant and Federal Work Study (FWS)
- Board of Governors Fee Waivers
- Scholarships
- Federal Supplemental Educational Opportunity Grant (FSEOG)
- Federal Perkins Loans
- Federal Direct Loans
- Academic Competitiveness Grant (ACG)
- California State Grants (Cal Grants)

Students can apply for one or more of these programs by filing a Free Application for Federal Student Aid (FAFSA). For additional information, contact the Financial Aid office or stop by and pick up an "Information Guide", your guide to financial aid programs and services in the Los Angeles Community College District. For detailed explanations related to obtaining and using financial aid, please call for an appointment with a Financial Aid Technician. Office hours: 9:00 a.m. – 2:00 p.m., Monday-Friday and 4:30 p.m. – 7:30 p.m., Monday-Thursday.

IMPORTANT NOTICE: You may have to repay federal funds if you are paid for classes you did not attend or stopped attending. Contact the Financial Aid Office before withdrawing from your classes! (213) 763-7082, Student Services Building, ST-214.

GAIN/CALWORKS

(213) 763-7109

Location: Student Services Building, ST-403

GAIN/CalWORKs is a job training program that provides extensive services for the participants receiving Temporary Aid for Needed Families (TANF). Educational services; academic, career and personal counseling and case management; job development/placement, and assistance with the cost of books and supplies are some of the services provided. Office hours: Monday – Friday, 8:00 a.m. – 4:00 p.m., and posted evening hours.

INFORMATION CENTER

(213) 763-5337

Location: Student Services Building -ST-LobbyThe Information Center provides general information about the campus, programs and services LATTCC has to offer. Bilingual student employees are also available to assist the ESL population with their inquiries. Office hours: 8:30 a.m. – 7:00 p.m., Monday through Thursday, 8:30 a.m. – 3:00 p.m., Friday.

INTERNATIONAL STUDENTS

(213) 763-5345

Location: Student Services Building, ST-415

Los Angeles Trade-Technical College (LATTCC) welcomes applications from international students. We also accept transfer applications for F-1 Visa students currently studying in the U.S. as well as Change of Status applications for visitors who currently have other visas. Applications may be obtained by contacting the office or on-line. Office Hours: Mon-Thurs. 9:00 am - 5:00 pm, Fri. 9:00 am - 3:00 pm. Office hours are subject to change. Please call for an appointment. Website: <http://college.lattc.edu/international/> • Email: intstud@lattc.edu

LIBRARY

Circulation: (213) 763-3950

Reference Desk: (213) 763-3958

Location: LRC

The Library is located on the first and second floors of the Learning Resources Center. Available materials include books, periodicals, microforms and CD-ROM applications. The book collection, periodicals and encyclopedias can be accessed through the online public access catalog. Library hours: Monday – Thursday, 8:00 a.m. – 6:50 p.m., Friday, 8:00 a.m. – 1:00 p.m., closed Saturdays, Sundays and school holidays.

MATRICULATION

(213) 763-5348

Location: Student Services Building, ST-303

Matriculation services at Trade-Tech are designed to maximize student's opportunities to succeed. Services include: Basic Skills assessments and Accuplacer exams; on-line and in-person orientation; and "Early Alert" services providing mid-semester evaluation of your academic progress. The Matriculation Office is located in ST-303. Office hours: Monday through Thursday, 8:30 a.m. – 7:00 p.m.

PUENTE PROJECT

(213) 763-3771

Location: Student Services Building, ST-413

The Puente Project is an academic preparation program whose mission is to increase the number of educationally disadvantaged students to transfer to a college or a university, earn college degrees and return to the community as members and leaders for future generations. Puente uses a combination of

teaching, counseling and mentoring to achieve its educational objectives. For more information about the program, contact Puente Office. Hours: Tuesday & Thursday, 8:30 a.m. – 4:00 p.m.

STUDENT ACTIVITIES OFFICE

(213) 763-7205

Location: C-105

This office coordinate extracurricular educational and social activities for students, including: clubs, ethnic/cultural programs, Deans and President's Awards ceremonies, social dances, blood drives, and the Associated Student Organization (ASO) Council. Office hours: 8:30 a.m. - 6:00 p.m., Monday to Thursday and 8:30 a.m. - 4:30 p.m. on Fridays.

STUDENT EMPLOYMENT CENTER

(213) 763-7124

Location: C-107A

This office assists students in finding full, part time or temporary jobs, and offers personal assistance with resumes and cover letters. It provides employment information to alumni related to their academic/ vocational program. Individual employment advisement is available by appointment. Office hours: 8:00 a.m. – 1:00 p.m. & 3:00 p.m. – 6:00 p.m., Monday – Thursday, 8:00 a.m. – 1:00 p.m., Friday.

STUDENT HEALTH CENTER

(213) 763-3764

Location: E-102

The Student Health Center offers non-emergency healthcare services to students, including preventative health education, physician services, and women's health. Hours are: Monday 10:00 a.m. - 6:00 p.m. Tuesday, Wednesday, Thursday 8:00 a.m. - 4:00 p.m., Friday 8:00 a.m. - 12:00 p.m.

UMOJA PROGRAM

(213) 763-7358

Location: Student Services Building, ST-416

Umoja is a Ki-Swahili (African) word for Unity. The Umoja Program is a community and critical resource dedicated to enhancing the cultural and educational experiences of African-American and other students. Umoja believe that when the voices and histories of students are deliberately and intentionally recognized, the opportunity for self-efficacy emerges and the foundation is formed for potential academic success. The following services are provided:

- Cultural events, field trips, and workshops
- Personal Development Classes (College Survival)
- Math & English Classes
- Umoja Counseling
- Mentoring & Life Coaching
- Career & Personal Development
- Financial Aid Services

UNIVERSITY TRANSFER CENTER

(213) 763-7154

Location: Student Services Building, ST-203

<http://college.lattc.edu/transfer/>

The University Transfer Center provides services to students interested in transferring to a four-year college or university, including workshops, appointments with visiting representative and trips to colleges and universities. Office hours: Monday- 9:00 a.m. to 6:00 p.m., Tuesday- 9:00 a.m. to 3:30 p.m., Wednesday- 9:00 a.m. to 3:00 p.m., Thursday 9:00 a.m. to 4:00 p.m., and Friday 9:00 a.m. to 1:00 p.m.

Associated Students Organization (ASO) is You!



Get involved with student activities at the best community college around.

Events. Clubs. Conferences. Discounts. Fundraisers. Fun.



Join the Associated Students Organization (ASO) family by coming by the ASO Office in the C-building or calling 213 763-7200.

ASO is the student government.

We advocate for student rights by addressing your issues and concerns.

We represent the 15,000-plus Trade Tech student body.



LOS ANGELES TRADE-TECH
LATTC
 A Community College

New Student Services Numbering System at LA Trade Tech

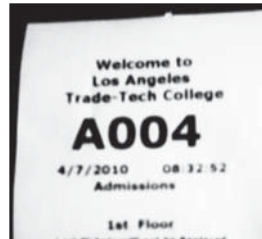

In order to better serve the needs of our students, as a campus, we are using a new queuing system designed to provide the most efficient service possible within the Student Services (ST) Building. We want all students to be familiar with the process, so it serves your needs.

- You **MUST** visit the Information desk first, located in the lobby of the ST-building to inquire if you will need a ticket number.
- If you need one-on-one service, you must secure a ticket (like the one pictured above) from the information desk. The numbers are different with each office, so the ticket guarantees you a place in line among those who need service from that office. Numbers are announced in the lobby over the speakers located inside and outside the ST-building. You may also check the selected screens inside and outside the ST-building to see if you have been called.
- It is best to wait outside until your number is called, then proceed to the proper office window for service. Please refer to your ticket for the proper office window. Please understand that numbers correspond to particular offices, so just because a higher number is called, it does not mean that the person jumped in front of you.

Thank you for your patience and cooperation as we strive to serve you more efficiently, and thank you for attending Los Angeles Trade-Technical College.



Los Angeles Trade-Technical College Foundation

400 W. Washington Blvd. ST 535, Los Angeles, CA

Phone: (213) 763- 7166 • Fax: (213) 763-5362

Website: <http://college.lattc.edu/foundation>

“Building a Foundation for the Great Future”

Join the LATTC Alumni Association Today!

Receive information about special events

Receive special alumni rates and discounts

Enjoy special programs created just for alumni

Network with other distinguished alumni

Complete the form and return it to LATTC Foundation 400 W. Washington Blvd ST 535, Los Angeles, CA 90015

Alumni Information

Name: _____

Year Graduated: _____

Program of Study: _____

Address: _____

City: _____

State: _____

ZIP Code: _____

Telephone (home): _____

Telephone (business): _____

E-Mail: _____

This information is for LATTC Foundation use only and will not be released to third parties.
LATTC is a tax-exempt non-profit 501(c)(3) corporation.

DIRECTORY

FROM OFF CAMPUS: DIAL (213) 763-XXXX (SEE LISTED PHONE NUMBER)

INFORMATION & SERVICES

Activities	Phone No.	Room
A		
Academic Senate	763-7167	TG
Admissions & Records	763-5300	ST-Lobby
<ul style="list-style-type: none"> • Academic Renewal 763-5320 ST-Lobby • Adding/Dropping a Class 763-5300 ST-Lobby • Applying for Admissions 763-5300 ST-Lobby • Academic, Administrative & Grade Change Petition 763-5312 ST-Lobby • CCCApply (on-line application) <ul style="list-style-type: none"> A – C763-5317 D – E763-5318 F – G763-5314 H – J763-5311 K – L763-5304 M – N763-5305 O – Q763-5307 R – S763-5306 T – V763-5309 W – Z763-5312 • Credit by Exam 763-5320 ST-Lobby • General Petitions 763-5314 or 5317 ST-Lobby • Graduation Application 763-5306 ST-Lobby <ul style="list-style-type: none"> A – E763-5308 ST-Lobby F – K763-5320 ST-Lobby L – R763-5302 ST-Lobby S – Z763-5322 ST-Lobby • Registration Questions 763-5300 ST-Lobby • Residency Questions 763-5300 ST-Lobby • Transcript Request 763-5309 ST-Lobby <ul style="list-style-type: none"> A – L763-5318 ST-Lobby M – Z763-5304 ST-Lobby • Verification of Enrollment 763-5307 In Person • Veterans 763-5305 ST-Lobby • Withdraw from College 763-5300 ST-Lobby 		
Allied Health/Health Occupation	763-7170	TG
Assessment	763-5339	ST-303
Associated Student Organization (ASO)	763-7200	C-108
Athletics	763-3726	J-202

Activities	Phone No.	Room
B		
Basic Skills Office	763-5515	K-006
Bookstore	763-7210	K-102
<ul style="list-style-type: none"> • Books, Supplies, Catalog, Schedule 		
Bridges to Success Center	763-5560	ST-316
<ul style="list-style-type: none"> • K-12 Enrollment • Noncredit courses 		
Business Office	763-7225	ST-109
<ul style="list-style-type: none"> • Accounts Payable 763-7236 ST-109 • Bus Passes and Tokens 763-7225 ST-109 • Check Distribution 763-7225 ST-109 • Fees Payment and Refund 763-7225 ST-109 • Registration Receipt 763-7225 ST-109 • Student ID Cards 763-7225 ST-109 • Student Parking Permits 763-7225 ST-109 		
C		
Cafeteria	763-7331	H Bldg
CAHSEE to College	763-5560	C-108
CalWORKs/GAIN	763-7109	ST-403
Child Development Center	763-3690	Olive & 21st
College Information Center	763-5337	ST-Lobby
College Sheriff	763-3600	D-150
<ul style="list-style-type: none"> • Emergencies 763-3611 D-150 • Locating a Student (emergency) 763-3611 D-150 • Lost & Found 763-3600 D-150 • Parking Enforcement 763-3600 D-150 		
Compliance Office	763-7066	LRC-257
Continuing Education/Noncredit	763-5560	ST-319
Counseling Center	763-7354	ST-416
D-F		
Disabled Student Programs & Services	763-3773	E-110
EOPS Programs	763-7097	ST-205
EOPS/CARE	763-7117	ST-205
Financial Aid Lab	763-7082	ST-314
Financial Aid Office	763-7082	ST-214
<ul style="list-style-type: none"> • Financial Aid/ Fee Waiver • Loans (Government) • Scholarships 		

DIRECTORY

INFORMATION & SERVICES

Activities	Phone No.	Room
G-I		
GAIN/CalWORKs	763-7331	ST-403
Garden Room	763-7331	H-108
Graduation Ceremony	763-7097	C-105
Health/Physical Education	763-3730	J-202A
Information Center	763-5337	ST-Lobby
<ul style="list-style-type: none"> • Campus Information • Schedules/Catalogs • Student ID Card 		
International Students	763-5345	ST-415
L-P		
Labor Studies	763-7129	L-220
Learning Skills Center	763-3738	C-102
<ul style="list-style-type: none"> • Learning Skills Computer Lab • Open Computer Lab • Reading Center • Tutoring Center • Writing Center 	763-3738 763-7208 763-3753 763-3738 763-3797	C-102 C-109 C-102 C-102 C-100
Library	763-3950	LRC
<ul style="list-style-type: none"> • Circulation • Reference Desk 	763-3950 763-3958	
Matriculation	763-5348	ST-303
<ul style="list-style-type: none"> • Assessment • Orientation • New Student Counseling • Prerequisite Clearance • Challenge Process 	763-5339 763-5336 763-7354 763-5339 763-5339	ST-303 ST-303 ST-416 ST-303 ST-303
Noncredit	763-5560	ST-316
Open Computer Lab	763-7208	C-109
PUENTE Program	763-3771	ST-413

Activities	Phone No.	Room
R-S		
Reading Center	763-3753	C-106
Student Relations/Recruitment/ Outreach	763-5329	K-003
Student Activities	763-7205	C-108
<ul style="list-style-type: none"> • Awards/Honors • Campus Clubs • Notices (Posting on Campus) • Student Government 	763-7205 763-7205 763-7205 763-7200	C-108 C-108 C-108 C-108
Student Employment Center	763-7124	C-107A
<ul style="list-style-type: none"> • Job Placement 	763-7124	C-107A
Student Grievance	763-7066	LRC-257
Student Health Center	763-3764	E-102
<ul style="list-style-type: none"> • Accidents • Health Services 	763-3764 763-3764	E-102 E-102
T-W		
Tutoring Center	763-3738	C-102
University Transfer Center	763-7154	ST-203
Veterans Affairs	763-5305	ST-Lobby
Wellness Center	763-3746	E-102
Writing Center	763-3797	C-100

COLLEGE ADMINISTRATION

Name	Phone No.	Room
Dr. Roland Chapdelaine, President	763-7052	ST-542
Anna Badalyan, Dean, Institutional Effectiveness	763-7064	ST-531

ACADEMIC AFFAIRS

Dr. Kathleen Burke-Kelly Interim Vice President, Academic Affairs	763-7022	ST-505
Vincent Jackon, Dean, Academic Affairs	763-7035	ST-521
Cynthia Morley-Mower, Dean, Academic Affairs	763-7074	ST-517

ADMINISTRATION

Dr. Mary Gallagher, Vice President, Administration	763-7040	ST-534
Marcus Anglin, College Financial Administrator	763-7225	ST-109
Bill Smith, Facilities Manager	763-3612	D-152

STUDENT SERVICES

Ramon Castillo, Vice President, Student Services	763-7078	ST-512
Dr. Raul Cardoza, Dean, Enrollment Management	763-5301	ST-120
Dr. Theda Douglas, Dean, Student Services	763-7097 or 7098	ST-230
Ms. Dorothy Smith, Dean, Matriculation and Student Success	763-5507	ST-519
Derek Majors Associate Dean, EOPS/CARE/DSPS	763-7116	ST-217
Luis Dorado Assistant Dean, Student Activities	763-7207	C-105

WORKFORCE & ECONOMIC DEVELOPMENT

Marcy Drummond, Vice President, Workforce & Economic Development	763-7036	ST-305
Leticia Barajas, Dean, Academic Affairs	763-7071	ST-320

DEPARTMENT HEADS

Name	Phone No.	Room
Admissions & Records - Carolyn Clark	763-5316	ST-116
Allied Health - Dr. Rita Weingourt	763-7185	TG-100
Art Trades, Fashion - Carole Anderson	763-3640	D-222
Athletics - Dimitri Lagos	763-3728	J-202
Behavioral/Social Sciences/Child Development - Alicia Rodriguez-Estrada	763-3938	TE-516
Bridges to Success - Dr. Allison Tom-Miura	763-3759	ST-316
Business/CIS/Computer Applications & Office Technology - Paulette Bailey	763-7258	K-225
Business Office - Marcus Anglin	763-7227	ST-109
Child Development Center - Pauline Carrillo	763-3690	Olive & 21st
College Sheriff - Deputy Diane Dodd	763-3600	D-150
Community & Economic Development - Dr. Denise Fairchild	763-3757	C-210
Compliance - Dr. Letia Royal-Burnett	763-7066	LRC-257
Construction, Design & Manufacturing - William D. Elarton	763-3701	B-122
Continuing Education/Noncredit - Leticia Barajas	763-7071	ST-320
Cosmetology - Marilyn Maine	763-7139	H-130
Counseling Center - Tom Dawkins	763-7361	ST-416
Culinary Arts - Steve Kasmar	763-7331	H-117
Electronics Technology - Eric Chavez	763-3782	K-325
EOPS/CARE - Derek Majors	763-7116	ST-217
Financial Aid Office - Cecilia Kwan	763-7082	ST-214
GAIN/CalWORKs - Linda Cole	763-7109	ST-403
Health/Physical Education - Joseph Ratcliff	763-3730	J-202A
Information Center/Matriculation/21st Century/Reading Center/Writing Center/Tutoring Center - Dorothy Smith	763-5510	ST-515
Labor Center - John McDowell	763-7129	L-220
Language Arts/Humanities - Rodrigo Palacios	763-3923	F-212
Learning Skills Center/ESL - Dr. Ayesha Randall	763-3738	C-102
Library - Vacant	763-3964	L-215
Math - Margaret Murphy	763-7320	TE-508
Noncredit - Dr. Allison Tom-Miura	763-3759	C-108
Physical Plant - Bill Smith	763-3612	D-152
Sciences - Xenia Wright	763-7295	K-405
Transportation - Rudy Serrato	763-3900	F-108K

ACADEMIC DEPARTMENTS & FACULTY

Name	Phone No.	Room
ALLIED HEALTH		
Allied Health &, Health Occupations	7170	TG
Wickman, Yvette	7170	TG
Ashby, Cynthia	7178	TG
Battams, Brian	7172	TG
Chandler, Christine	7194	TG
Davis-Kendrick, Maggie	7181	TG
Jacobs, Loreto	7177	TG
Jenkinson, Deborah	7176	TG
Middleton, Rosemary	7173	TG
Reiley, Joyce	7179	TG
Rodriguez, Angel	7186	TG
Soles, Barbara	7193	TG
Villora, Rosalie	7180	TG
Washington, Carolyn	7174	TG
Weingourt, Dr. Rita	7182	TG

BEHAVIORAL & SOCIAL SCIENCES

Chen, Shirley	5513	TE-516
---------------	------	--------

Social & Behavioral Sciences: Anthropology

Huld, Phillip	5504	TE-520r
---------------	------	---------

Social & Behavioral Sciences: Child Development

Babb, Jing	3954	H 350
Maina, Dr. Gathoni	3953	H 350
Vega, Cecelia	3986	H 350

Social & Behavioral Sciences: History

Rodriguez-Estrada, Alicia	5513	TE-516
Jackson, Diana	5503	TE-520u
Robinson, Thurman	3932	TE-520t

Social & Behavioral Sciences: Political Science

Vaden, Dr. Bradley	3927	L-266
--------------------	------	-------

Social & Behavioral Sciences: Psychology

Essex, Dr. Robert	3933	F 225j
Koritzke, Leslee	5505	TE-520q

Social & Behavioral Sciences: Sociology

McClain, Dr. Freddie	3936	TE-520v
----------------------	------	---------

BUSINESS/CAOT/CIS

Bailey, Paulette	7269	K 225
Amarawansa, Karen	7253	K 225

Business / Management

Montour, Clifford	7260	K 209
Ahmad, Jamil	7257	K 209
Bessler, Maida	7263	K 260
Endman, James	7252	K 225
Gary, Esq., Karl	7255	K 203b
Gonzalez, Raymond	7259	K 209
Johnson, Ed	7252	K 225
Scudder, Stuart	7252	K 225
Seetao, David	7252	K 225
Shaw, MD	7252	K 225
Sherer, Richard	7265	K 266
Taylor, Melvin	7261	K 209
Taylor, Pamela	7252	K 225
Toure, Yolanda	7252	K 225

Name	Phone No.	Room
------	-----------	------

Computer Applications/Office Technologies

Bailey, Paulette	7258	K 209
Baklayan, Shoushan	7264	K 264
Chu, Eleanor	7267	K 306
Haymon, Sharon	7252	K 225
Palacios, Valda	7252	K 225
Thornhill, Dorothy	7266	K 306a
Viramontes, Max	7256	K 208a

Computer Information Systems

Auciello, Joseph	7268	K 309
Burton, Wanda	7252	K 225
Crunkleton, Joseph	7252	K 225
Emerson, Victoria	7252	K 225
Hahne, Louis	7254	K 309
Kapaku, Okima	7252	K 225
Mata, Antonio	7252	K 325b
Moore, Donald	7252	K 225
Phillips, G. W.	7252	K 225
Proctor, Ernest	7252	K 225
Roberts, Ronald	7252	K 225
Tee, Vincent	7252	K 225

COMMUNITY PLANNING & ECONOMIC DEVELOPMENT

Community Planning &, Econ. Dev.	3757	C 204
Fairchild, Dr. Denise	3760	C 210
Torres, Benjamin	3757	C 210

CONSTRUCTION, DESIGN & MANUFACTURING

Construction Design, & Mtg.	3700	B 122
Elarton, William	3701	B 122
Walters, Yvonne	3700	B 122

Architecture

Freeland, David	3677	D 331a
Gallegos, Patricio	3674	B 303a
Garcia, Emmanuel	3673	B 303b
Harirchi, Ladan	3700	B 122
Lewis, Jill	3672	D 302b
Murdock, Scott	3673	D 302b
Oliva, Marcela	3676	D 330b
Stenhouse, Douglas	3669	D 331b

Carpentry

Dunn, Roger	3704	B 104a
Hinoki, Ron	3700	B 122
Hubbard, Larry	3709	B 134b
Lawrence, Reed	3700	B 122
McAndrews, Robert	3700	B 122
Porter, Henry	3700	B 122
Vessella, Thomas	3707	B 134a
Woo, George	3703	B 104b

Electrical

Brkic, Ferdo	3700	B 122
Burke, Dennis	3740	B 337c
Curtin, Kevin	3700	B 122
Dominguez, John	3700	B 122
Goluzza, Brano	3700	B 122
Jackson, Ronald	3723	B 337a
Karhas, Nicholas	3700	B 122
Lester, John	3721	B 330a
Maalouf, Eli	3700	B 122
Nasrallah, Ghassan	3700	B 122
Nieves, Thomas	3722	B 304b

ACADEMIC DEPARTMENTS & FACULTY

Name	Phone No.	Room
Pogoler, Lawrence	3720	B 304a
Ramirez, Roberto	3700	B 122
Robinson, David	3718	B 301a
Rogers, Merle	3724	B 351a
Seitz, John	3745	B 337c
Sussman, Daniel	3700	B 122
Takaguchi, Ronald	3700	B 122
Uchida, Hiroshi	3719	B 304a
Wiegand, Carl	3700	B 122
Winston, Ray	3700	B 122
Ying, Supot	3700	B 122
Yow, Yuzo	3700	B 122

Machine Shop

Rauterkus, Peter	3941	F 166b
Shibuya, Steven	3946	F 164j
Vo, Chuong	3945	F 164b
West, P	3700	F 166
York, David	3700	F 166

Plumbing

Dean, Craig	3710	B 252a
Freidenberger, Karen	3700	B 122
Jones, Larry	3717	B 200c
Lunt, Charles	3700	B 122
Slade, Timothy	3710	B 252a
Swiegart, T	3700	B 122
Weinstock, Stanley	3711	B 202
Yates, Robert	3700	B 122

Refrigeration & Air Conditioning

Allen, Gene	3700	B 122
Barnett, Craig	3712	B 237c
Brady, Patrick	3700	B 122
Cioffi, Gabriel	3714	B 238a
Corbin, Bobby	3700	B 122
Datis, Angelo	3700	B 122
Dozier, Kelly	3715	B 221c
Espinoza, Albert	3700	B 122
Kahng, Paul	3700	B 122
Needham, Matthew	3743	B 204a

Welding

Chancy, Che	3949	F 150b
Holley, James	3948	F 156d
Legohn, Lisa	3942	F 156j
Newell, Renee	3944	F 151e

COSMETOLOGY

McClendon, Jamille	7133	H-130
Aguilar, David	7133	H-130
Maine, Marilyn	7139	H-130
Chen, Lina	7136	H-130
Ley, Lidia	7147	H-130
Lopez, Rosa	7145	H-130
Mercado, Dyana	7133	H-130
Monge, Jacqueline	7133	H-130
Robinson, Elton	7138	H-130
Shackelford, Sondra	7140	H-130
Smith, Felicia	7133	H-130
Young, Carolyn	7133	H-130

CULINARY ARTS

Culinary, Arts	7331	H 118
Kasmar, Steven	7332	H 118
Cole, Pamela	7333	H 117
Blanchard, Leroy	7342	H 108
Delrosario, Giovanni	7347	H 131b

Name	Phone No.	Room
Feigenbaum, Susan	7341	H 108
Kanemaki, James	7331	H 118
Lisanti, Jim	7343	H 108
Sims, Eddie	7346	H 131
Spence, Roselyn	7331	H 108
Vachon, Jerry	7331	H 108

Professional Baking

Damaso, Stacy	7335	H 106
Thompson, Deborah	7351	H 315
Wemischner, Robert	7352	H 315

ELECTRONICS TECHNOLOGY

Electronics, Technology	3782	E 217
Chavez, Eric	3789	K-325
McClendon, Jamille	3788	E 217
Campbell, Dr. Robert	3782	E 219c
Cyrus, Shawn	3786	E 219b
Roosta, Soroya	3971	E 305a
Venegas, Rafael	3796	E 311

FASHION, VISUAL COMMUNICATIONS & ART TRADES

Fashion, Center	3640	D 222
Anderson, Carole	3642	D 222
Fernando, Tessie	3640	D 222

Fashion Design

Adams, Ludmila	3640	D 222
Brand-Njoku, Mary	3655	D 203a
Brooks, Marva	3640	D 222
Coreas, Madeline	3643	D 230a
Cunnigan, Dixie	3640	D 222
Drebskaya, Finna	3650	D 130a
Foral, Dorothy	3640	D 222
Gale, Joyce	3647	D 106a
Glass-Villalobos, Nurit	3657	D 105b
Iaffaldano, Cinzia	3649	D 130b
Jackson, Tiffany	3661	D 332b
Johnson, Deborah	3640	D 222
Kim, Hyein	3644	D 102b
Lee, Aileen	3658	D 102a
Melin, Linda	3640	D 222
Petrie, Iris	3640	D 222
Sapos, Carol	3651	D 133b
Stafford, William	3640	D 222
Thornton, Della	3648	D 106b
Torda, Benito	3640	D 222
Watanabe, Ruth	3645	D 105a

Fashion Merchandising

Murphy, Diane	3654	D 203a
---------------	------	--------

Tailoring

Iapaolo, Nino	3640	D 222
---------------	------	-------

Sign Graphics

Guthrie, Ralph	7367	H 204
----------------	------	-------

Visual Communications

Evans, George	7372	F-240
Hubbard, Roger	7363	F-240
Mendoza, Laura	7363	F-248
Millar, Norman	7363	F-240
Morris, Fred	7363	F-240
Robles, William	7363	F-240

ACADEMIC DEPARTMENTS & FACULTY

Name	Phone No.	Room
LABOR CENTER		
Labor, Center	7129	L 220
McDowell, John	7129	L 213
De La Torre, Vivien	7129	L 210
Garcia, Olga	7129	L 220
Siegel, Lou	7129	L 212
Yasuda, Kathleen	7160	L 211

LANGUAGE ARTS / HUMANITIES

Language Arts/Humanities: Art		
Malone, Annie	3923	F 212

Language Arts/Humanities: English		
Ahmed, Ahmed	3923	F 212
Blake, George	3923	F 212
Dalrymple, Roxann	5511	F 212
Daniels, Jeff	3923	F 212
Dolan, Theresa	5502	F 240a3
Doss, Howaida	3923	F 212
Gangel-Vasquez, Janice	3929	F 212j
Gonzalez, Dr. Michael	7288	K 203g
Gregory, Eric	3923	F 212
Jacobs, Brian	3923	F 212
Kobler, Mark	3923	F 212
Lennon, Frankie	3923	F 212
Mancia, Roberto	3770	ST 413
McCants, Gwen	3923	F 212
Mendez, Armando	3923	F 212
Menzies, Edgar	3923	F 212
Mitchell, Sharis	3923	F 212
Moreno, Lisa	5506	F 240f
Ryder, William	3923	F 212
Shakir-Blackshere, Rashidah	3930	F 212g
Stahl, Lisa	3923	F 212
Villani, Frank	3923	F 212

Language Arts/Humanities: Fine Arts		
Herbert, Pamela	3937	F 240d
Szymanski, Gary	7378	H 236b
Williams, Frank	3923	F 212

Language Arts/Humanities: Humanities		
Parker-Lopez, Carolie	7285	K 203f
Tropf, Ralph	3923	F 212

Language Arts/Humanities: Music		
Canon, Sherri	3668	D 300a
Ray, Eric	3923	F 212
White, Molly	5377 x 4012	D 300a

Language Arts/Humanities: Philosophy		
Egan, Richard	3923	F 212
Sargeant, Mark	3923	F 212

Language Arts/Humanities: Spanish		
Buscaglia, Renatta	7274	K 366b
Drake, Millie	3923	F 212
Linares, Manuel	3923	F 212
Quinones, Hernan	7291	K 366a
Ross, Rose	3923	F 212

Language Arts/Humanities: Spanish/French		
Palacios-Ochoa, Rodrigo	7289	K 364a

Name	Phone No.	Room
Language Arts/Humanities: Speech		
Borne, Alvin	3923	F 212
Glavan, Dr. John	3931	TE-520
McNamara, Catherine	3923	F 212
Mock, Jearold	5517	TE-520
Wood, Deirdre	3926	TE-520

Language Arts/Humanities: Theater		
Harmetz, E.	7290	K 366b

LEARNING SKILLS

Learning Skills Center	3738	C 102
Randall, Ayesha	3739	C 100d
Anketell, Christina	3741	C 100c
Armstrong, Maria	3698	C 100c
Cole, Valerie		
Grunbaum, Dorien	7284	K 203e
Harley, Norma		
Iniguez, Noe	3738	C 104
Kinyon, Kindra	7283	C 100c
Le Veque, Victoria	3938	C 102
Nwoko, John	3738	C 102a
Pham, Minh	3738	C 104
Porter, Alfred	3738	C 102

LIBRARY SCIENCE

Nitsch, Lisa	3978	LRC
Samuel, Judith	3959	LRC

MATHEMATICS

Mathematics, Dept.	7330	K 203d
Murphy, Margaret	7320	K 203d
Bakman, Dr. Anna	7299	K 203h
Lee, Dr. Kuen	7314	K 203a
Light, Eugene	7301	K 203h
Liu, Hsiao-Ling	7315	K 203a
Meftagh, Tayebbeh	7319	K 203b
Simpson-Rogers, Nii	7329	K 203d

MORTGAGE FINANCE

Mortgage Finance, Program	3757	C 204
---------------------------	------	-------

NONCREDIT/CONTINUING EDUCATION

Tom-Miura, Dr. Allison	3759	C 108
------------------------	------	-------

PHYSICAL EDUCATION/HEALTH/ATHLETICS

Athletics, Physical Education	3726	J 202
Ratcliff, Joseph	3730	J 202a
Hale, Tracy	3727	J 202
Browne, James	5524	J 204
Budinger, John	5377 x 4069	J 213
De Franco-Browne, Diane	3732	J 210
Delzeit, Linda	3733	L 270
Lagos, Dimitri	3728	J 202
Orozco, Oscar	3734	G 104
Pfiffner, Brian	5377 x 4076	J 202
Physical Education, Athletics	3726	J 202
Sullivan, Dr. Sally	3731	J 210
Wagenbach, Michael	3729	J 203
Wells, Richard	3737	J 201

ACADEMIC DEPARTMENTS & FACULTY

Name	Phone No.	Room
SCIENCES		
Sciences: Biology		
Avila, Luis	7300	K 203d
Brockmann, Erika	7306	K 402
Denton, Dr. Timothy	7297	K 423c
Gbonegun, Olu	7295	K 405
Kunarak, Sanya	7310	K 203d
Lavinger, Steve	7295	K 405
Neddermeyer, Karl	7295	K 405
Olsen, Bruce	7295	K 405
Pantastico-Caldas, Dr. Marissa	7298	K 423f
Pappas, Nick	7295	K 405
Ramaraj, Pandurangan	7295	K 405
Shank, Barbara	7295	K 405
Wright, Xenia	7296	K 405a
Sciences: Chemistry		
Ajje, Dr. Henry	7295	K 405
Darmanyan, Dr. Pavel	7295	K 405
Diaz, Dr. Martin	7302	K 423b
Harutunian, Dr. Vahak	7317	K 423e
Houban, Dr. Karl	7324	K 423h
Jeffress, David	7304	K 401
Powers, Dr. Richard	7295	K 405
Ruiz-Silva, Dr. Beatriz	7311	K 423f
Sciences: Geology		
Colazas, Xenophon	7295	K 405
Sciences: Microbiology		
Hosseini, Mansour	7295	K 405
Wong, Ricky	7313	K 423b
Sciences: Physical Geography		
Landau, Dr. Daniel	7295	K 405
Schwartz, Gregory	7295	K 405
Sciences: Physics		
Goodman, Todd	7295	K 405
Parkin, Steve	7295	K 405
Sciences: Physics/Astronomy		
Moreno, Dr. Miguel	7322	K 423g
Padilla, Fred	7323	K 423h
Santojanni, Donald	7307	K 403
Sciences: Physics/Engineering		
El Tawansy, Mohamed	7321	K 423g
Sciences: Process Plant Technology		
Madyun, Renee	7318	K 423e
Sutton III, Dr. Cash	7295	K 405
Sciences: Solid Waste Mgmt.		
Blount, Paul	7295	K 405
Sciences: Supply Water		
Amir-Teymoori, Abbas	7295	K 405
Sciences: Wastewater		
Abd El Aal, Mohamed	7295	K 405
Abkian, Varout	7295	K 405

Name	Phone No.	Room
STUDENT SERVICES - COUNSELORS		
Abraham, Angeles	7117	ST-205
Ahn, Inhae	7156	ST-422
Almada, Christina	7360	ST-424
Brent, Lourdes	7117	ST-205
Bukasa, Lorna	7117	ST-205
Burnett, Maurice	7358	ST-418
Campbell, Deborah	7359	ST-434
Cole, Linda	7109	ST-403
Dawkins, Thomas	7361	ST-432
Esparza, David	7158	ST-203
Gray, Kamale	5342	ST-416
Hopper, Michael	7109	ST-403
Hosseini, Ashraf	7157	ST-413
Johnson-Taylor, Chini	7366	ST-410
Madrid, George	7360	ST-430
Munoz, Ana	7117	ST-205
Rosario, Gliceria	7117	ST-205
Skinner, Kyle	7117	ST-205
Tishler, Sheila	7097	ST-420

TRANSPORTATION		
Transportation	3900	F 114
Serrato, Rudy	3901	F 114
Scherb, Eva	3902	F 114
Chung, Peter	3909	F 106d
Encinas, Dan	3939	F 132
Goy, Bruce	3900	F 114
Grissett, Robert	3900	F 114
Guerra, Ricardo	3900	F 114
Marroquin, Manuel	3914	F 116b
McFall, Thomas	3917	F 122
Spear, George	3907	F 104
Uribe, John	3910	F 108a
Williams, Terry	3906	F 102
Woo, William	3920	F 128

Collision Repair		
Ferre, Brian	3912	F 110g
Morago, Fred	3916	F 120b
Muradian, Sarkis	3916	F 120b
Singh, Santock	3900	F 110a

Diesel and Related Technology		
Cavanaugh, John	3905	F 100a
Guerra, Jesus	3919	F 126a

Motorcycle Repair		
Price, Robert	3918	F 124a

DIRECTORY

Public Transportation to Los Angeles Trade-Technical College

Metro Rail/Bus Lines (www.mta.net):

Access from:

Metro Rail	Blue, Gold, Green, Orange and Red Lines	Blue Line Grand Station
2/302	Downtown Los Angeles - Pacific Palisades via Sunset Bl	Broadway/Venice
4	Downtown Los Angeles - West Los Angeles - Santa Monica via Santa Monica Bl	Broadway/Venice
10	Downtown Los Angeles - West Hollywood via Temple St & Melrose Av	Main/Venice
14	Downtown Los Angeles - Beverly Hills via Beverly Bl	Grand/Venice
20	Downtown LA - Santa Monica via Wilshire Bl	Red Line>Blue Line>Grand Station
33/333	Downtown LA - Santa Monica via Venice Bl	Red Line>Blue Line>Grand Station
35/335	Downtown Los Angeles - Fairfax/Washington via Washington Bl	Broadway/Venice
37	Downtown Los Angeles - Fairfax/Washington via Adams Bl	Grand/Venice
38	17th/Broadway - Fairfax/Washington via W. Jefferson Bl	Grand/Jefferson
40	South Bay Galleria - Union Station via Hawthorne Bl, Crenshaw Bl & ML King Bl	Broadway/Washington
42	LAX - Downtown LA via LAX City Bus Center, LaTijera Bl, Stocker St & M.L.King Bl	Broadway/Washington
45	Lincoln Heights - Rosewood via Broadway	Broadway/Washington
48	Downtown Los Angeles-Avalon Station via Main St & South San Pedro St	Main/Venice
55/355	Downtown LA - Imperial Station via Compton Av	Grand Station
66/366	Wilshire Center - Montebello via 8th St & Olympic Bl	Red Line>Blue Line>Grand Station
68/84	West Los Angeles - Montebello via Washington Bl & Cesar Chavez Av	Red Line>Blue Line>Grand Station
78/79/378	Arcadia - Los Angeles via Huntington Dr & Las Tunas Dr	Olive/Venice-18 th
83	Eagle Rock - Downtown LA via York	Hill-Main/Venice
90/91	Downtown LA - Sunland via Glendale Av, Foothill Bl	Hill/Venice
94	Downtown Los Angeles-Sylmar Station via Hill St & San Fernando Rd	Hill/Venice
96	Downtown Los Angeles-Sherman Oaks via Griffith Pk Dr & Riverside Dr	Olive-Grand/Venice
439	LAX/Aviation Station - Downtown LA/Union Station via LAX, Westchester, etc.	Red Line>Blue Line>Grand Station
442	Hawthorne - Downtown LA via Hawthorne Bl, La Brea Av, Manchester Bl., etc.	Red Line>Blue Line>Grand Station
444	Rancho Palos Verdes - Downtown LA via Hawthorne Bl-Harbor /I-110 Fwy	Red Line>Blue Line>Grand Station
445	San Pedro - Union Station via Pacific Av, First St, Harbor Beacon Park Ride Lot, etc.	Red Line>Blue Line>Grand Station
446/447	San Pedro - Downtown LA/Union Station via Pacific Av., Avalon Bl, etc.	Red Line>Blue Line>Grand Station
484	Metro Local and Express (Pomona-Downtown LA via Valley Bl & El Monte Busway)	Olive/Venice-18 th
485	Metro Local and Express (Altadena-Downtown LA via Lake Av & El Monte Busway)	Olive/Venice-18 th
487/489	Sierra Madre Villa Gold Line Station-Downtown LA -- Temple City - Downtown LA	Red Line>Blue Line>Grand Station
490	Metro Local and Express (Pomona-Downtown LA via Ramona Bl & El Monte Busway)	Olive/Venice-18 th
603	Rampart Bl. - Hoover St-Allesandro St. - Colorado St.	Grand/Washington
730	Metro Rapid (Downtown LA-Pico Rimpau via Pico Bl)	Broadway/Temple
745	Metro Rapid (Downtown Los Angeles-Harbor Freeway Station via Broadway)	Broadway/Washington
794	Metro Rapid (Downtown Los Angeles-Burbank Station via San Fernando RD, Brand Bl)	Hill/Venice

Other transit lines that stop within a few blocks of the college include:

- . *LADOT DASH and Commuter Express (<http://www.ladottransit.com/>)*
- . *Foothill Transit (<http://www.foothilltransit.org/>)*
- . *Montebello Bus Lines (<http://www.cityofmontebello.com/depts/transit/bus/default.asp>)*
- . *Santa Monica Municipal Bus Lines (<http://www.bigbluebus.com/home/index.asp>)*
- . *Torrance Transit (<http://www.ci.torrance.ca.us/128.htm>)*

INDEX

A

Ability to Benefit Test	58
Academic Freedom	89
Academic Standards	89
Accuracy Statement	89
Adding Classes	13
Admission And Records	96
Application for Admission	63
Apprenticeship Education	86
Assessment Test	11
Attendance	89
Auditing Classes	8, 13

B

BOGF Waiver	59
Bridges to Success Center	96

C

C.A.R.E.	96
Campus Offices & Services	96
Campus Security Act/The Cleary Act	95
Cancelled Classes	13
Career Center	96
Child Development Center	96
Class Conflict	13
Class Listing	20
Honors	55
On-Line Classes	82
Cooperative Education	85
Apprenticeship Education	86
Instructional Television	87
Corequisites	12
Concurrent Enrollment	13
Conduct Expected of Students	89
Counseling Services	96
Course Repetition	13
Crime Reporting Procedures	95

D

Disabled Student Program	96
Disciplinary Action	94
Diversity	89
Dropping Classes	13
Drug-Free Workplace	90

E

E-Mail Accounts	90
Educational Environment Policy	90
Educational Programs	90
Emergency Information	90
Employment Center	97
English Proficiency	91
Enrollment Process	4
Extended Opportunity Program	96

F

Family Education Rights and Privacy Act	90
Fee Exemption - K-12	90
Fees at a Glance	8
Final Exam Schedule	111
Financial Aid	96
Application Process	57
ATB Test	58
BOGF Waiver	59
Foundation (LATTC)	100
Freedom of Speech Area	90

G

GAIN /CALWORKS	96
Grades and Grade Changes	90
Graduation	90
Plan A General Education	15
Plan B General Education	16
CSU General Education	17
IGETC General Education	18
Grievance Procedures	94

H

Health Center	97
Hope Scholarship Tax Credit	90

I

Information Center	85, 96
International Student Admission Office	13, 96
Instructional Resource Lab (IRL)	56
ITV - The Weekend College	87

L

Learning Skills Center	56
Library	97
Limited English Proficiency	90

M

Matriculation	97
---------------	----

N

New Student Services Numbering System	99
Non-Citizen Admission	13
Non-Credit Classes	79
Nondiscrimination Policy	91

O

Ombudsperson	94
On-line classes	82
Open Enrollment	92
Open Computer Lab	56
Orientations	6

P

Parking	14, 112
Pass/No Pass	90
Prerequisites	12
Public Transportations	108
Puente Program	97

R

Records and Directory Information	94
Registration by Proxy	14
Register by Internet	7
Residency Requirement	54
Resolution Process	88
Right to Know	95

S

Sexual Assault	92
Smoking Policy	92
Social Security Numbers	92
Standards of Student Conduct	92
Steps to Enroll	5
Student Activities Office	97
Student Records & Directory Information	74
Student Resolution Process	88
Student Rights and Responsibilities	95
Study Load	14

T

Transcripts	95
Tutoring Center	56

U

Umoja Program	97
University Transfer Center	55, 97

V

Verifications of Enrollment	95
Veterans	14
Viewing Your Records	95
Vision and Mission of LATTC	3

W

Web Enrollment	54
Writing Center	56

NOTES

FALL 2010 FINAL EXAM SCHEDULE

Final examinations are required of all classes and are required to be given within the designated final exam period; a two-hour period is scheduled for each examination.

The date of your final examination is determined by the first day and the first hour your class meets.

Final examinations must be held on the day and time scheduled and in your regularly assigned classroom.

Short-term Classes – Classes that are scheduled less than 15 weeks will have their final exam at the normal class time on the last day of instruction.

Weekend Classes – Classes that are scheduled on Friday only or Saturday only will have their final exam at the normal class time on Friday, December 17 or Saturday, December 18.

Evening Classes – Classes that meet at 3:30 p.m. or later will have their final exam at the normal class time on the last day of instruction.

For class times not listed or in case of conflicts or make-up exams – **please see instructor**. Instructors will need to consult with their Department Chair and Area Dean to determine final exam times for classes with start times that do not coincide with the standard time blocks listed below.

		7:00-9:00 am	9:30-11:30 am	12:00-2:00 pm	2:30-4:30 pm	5:00-7:00 pm	7:30-9:30 pm
Monday	December 13	Classes starting between 8:00-8:55 am Mon/Wed or starting between 7:00-8:55 am Monday only	Classes starting between 9:00-9:55 am Mon/Wed or starting between 9:00-10:55 am Monday only	Classes starting between 12:00-12:55 pm Mon/ Wed or starting between 11:00 am-12:55 pm Monday only	Classes starting between 1:00-3:15 pm Monday only	Classes starting between 5:00-5:55 pm Mon/Wed, or starting between 3:20-5:55 pm Monday only	Classes starting between 6:00-8:00 pm Monday only
	December 14	Classes starting between 7:00-7:55 am MTWTh, or Tues/Thurs, or starting between 7:00-8:55 am Tuesday only	Classes starting between 10:00-10:55 am MTWTh, or Tues/Thurs, or starting between 9:00-10:55 am Tuesday only	Classes starting between 11:00-11:55 am MTWTh, or Tues/Thurs, or starting between 11:00 am-12:55 pm Tuesday only	Classes starting between 1:00-2:55 pm MTWTh, or Tues/Thurs, or starting between 1:00-3:15 pm Tuesday only	Classes starting between 3:20-4:55 pm MTWTh, or Tues/Thurs, 3:20-5:55 pm or 3:20-5:55 pm Tuesday only	Classes starting between 6:00-8:00 pm MTWTh, or Tues/Thurs, or Tuesday only
Tuesday	December 15	Classes starting between 7:00-7:55 am Mon/Wed or Wed/Fri or starting between 7:00-8:55 am Wednesday only	Classes starting between 10:00-10:55 am Mon/Wed or Wed/Fri or starting between 9:00-10:55 am Wednesday only	Classes starting between 11:00-11:55 am Mon/Wed or Wed/Fri or starting between 11:00 am-12:55 pm Wednesday only	Classes starting between 1:00-2:55 pm Mon/Wed or Wed/Fri or starting between 1:00-3:15 pm Wednesday only	Classes starting between 3:20-4:55 pm Mon/Wed or Wed/Fri or 3:20-4:55 pm Wednesday only	Classes starting between 6:00-8:00 pm Mon/Wed or Wed/Fri or Wednesday only
	December 16	Classes starting between 8:00-8:55 am MTWTh, or Tues/Thurs, or starting between 7:00-8:55 am Thursday only	Classes starting between 9:00-9:55 am MTWTh, or Tues/Thurs, or starting between 9:00-10:55 am Thursday only	Classes starting between 12:00-12:55 pm MTWTh, or Tues/Thurs, or starting between 11:00-12:55 pm Thursday only	Classes starting between 1:00-3:15 pm Thursday only	Classes starting between 5:00-5:55 pm Tues/Thurs, or 3:20-5:55 pm Thursday only	Classes starting between 6:00-8:00 pm Thursday only
Wednesday	December 17	Classes starting between 8:00-8:55 am Wed/Fri, or starting between 7:00-8:55 am Fri/Sat or Friday only	Classes starting between 9:00-9:55 am Wed/Fri, or starting between 9:00-11:55 am Fri/Sat or Friday only	Classes starting between 12:00-12:55 pm Wed/Fri, or starting between 12:00-2:55 am Fri/Sat or Friday only	Classes starting between 1:00-2:55 pm Fri/Sat, or starting between 3:00-4:55 pm Fri/Sat or Friday only	Classes starting between 5:00-5:55 pm Fri/Sat or Friday only	Classes starting between 6:00-8:00 pm Fri/Sat or Friday only
	December 18	Classes starting between 7:00-8:55 am Saturday only	Classes starting between 9:00-11:55 am Saturday only	Classes starting between 12:00-2:55 pm Saturday only	Classes starting between 3:00-4:55 pm Saturday only	Classes starting between 5:00-6:55 pm Saturday only	No exams scheduled
Thursday	December 19	Classes starting between 7:00-8:55 am Sunday only	Classes starting between 9:00-11:55 am Sunday only	Classes starting between 12:00-2:55 pm Sunday only	Classes starting between 3:00-4:55 pm Sunday only	Classes starting between 5:00-6:55 pm Sunday only	No exams scheduled



Student Parking Guidelines

You are responsible for knowing LATTTC parking rules and regulations. This handout is intended to provide students with basic guidelines on parking at the college. The complete text of the college's parking rules and regulations is printed in the College Catalog and may also be obtained from the Sheriff's Department, D-150, the Administrative Services Office, or the College Website: (www.latttc.ca.us.html/Parking-Info.htm).

- Student parking regulations are enforced from the first day of classes each semester through final examinations. A student parking permit is valid for the current semester only and must be displayed at all times a vehicle is parked on college property. Saturday and Sunday parking permit use is enforced in the same manner as weekdays.
- Parking permits are made of removable mylar and should be affixed to the **inside rear window, (lower right side, facing outward.)** Vehicles displaying a permit which is expired, altered, reported lost or stolen, or not completely visible are subject to a citation.
- A valid college parking permit and a DMV placard must be displayed on any vehicle parked in a designated handicapped stall. Students with a verified disability should go to the Disabled Students Program and Services Office, E-110, to arrange for an accommodation.
- Regulations governing handicapped parking, red curbs, no-parking zones, fire lanes, special permit areas, and areas that have parking time limitations are enforced 24 hours a day, including weekends and holidays. **Failure to display a parking permit or parking in an area not authorized for student parking, including metered spaces, will result in the issuance of a citation. Illegally parked vehicles may be towed away at owner's expense.**
- All traffic laws must be obeyed. Vehicles must be parked in stalls within the designated lines. The college speed limit is 7 miles per hour.
- **The purchase of a parking permit does not guarantee a parking space; it is only a license to park one vehicle with a Student Parking Permit for all time periods in any of the designated areas specified below:**
 - **Olive Street Parking Facility** – Entrance from Olive St., between Washington Blvd. and 21st St.
 - **Roof Lot (F-Bldg)** – Entrance from Flower St. (Southbound ONLY), between 22 St. and 23rd St.
 - **22nd Street Lots B** – Entrance from 22nd St., between Grand and Olive
 - **Orthopedic Hospital** – Entrance off 23rd St., at Hope Ave., between Grand Ave. and Flower St.

OVERFLOW PARKING: LATTTC makes every effort to provide adequate parking for all students, staff and visitors. However, since student parking becomes extremely impacted during the first three weeks of the Fall and Spring semesters, we have made arrangements with our neighbor and community partner, **The LA Mart, at 1933 S. Broadway**, to provide overflow parking for LATTTC students in their East lot. The lot is accessible from Broadway or Main just south of Washington Blvd., and will be available to students with a valid parking permit for the first three weeks of the Fall and Spring semesters ONLY.

- LATTTC assumes no responsibility or liability for your car or its contents while parked in the lots. However, since vibrations sometimes cause a false trigger of motion detectors, we ask that you be considerate of our neighbors in setting the volume level and sensitivity settings for any car alarm on your vehicle.
- Escort service is provided upon availability. Call the College Sheriff's Department and an officer will be dispatched to your location.

Inquiries regarding the college's parking permit program should be directed to the offices listed below during normal business hours. College Sheriff's Department personnel are, however, on duty 24 hours a day, seven days a week to assist with permit use and enforcement issues.

- **Parking Rules, Regulations, Permit Use and Enforcement:** College Sheriff's Department, D-150, (213) 763-3600. Individuals who believe a citation was issued to them in error must appeal it immediately by completing an Administrative Review form (available at the Sheriff's Department, D-150) or the LATTTC Sheriff's Department website under Parking Citations and Appeals). Appeals must be mailed to: Los Angeles Trade Technical College, c/o Parking Citation Service Center, P.O. Box 11923, Santa Ana, CA 92711. Failure to immediately pay or appeal a citation may result in substantial penalties and a Department of Motor Vehicle (DMV) hold on your vehicle registration.
- **Permit Sales, Refunds, and Exchanges:** Business Office, ST-113, (213) 763-7225.
- **Policy:** Administrative Services, ST-532, (213) 763-7040.

* *The parking information shown above is subject to change without notice.*

400 West Washington Blvd.
 Los Angeles, California 90015-4181
www.lattc.edu



Phone: (213) 763-7000
 TDD: (213) 763-5375
 Fax: (213) 763-5393

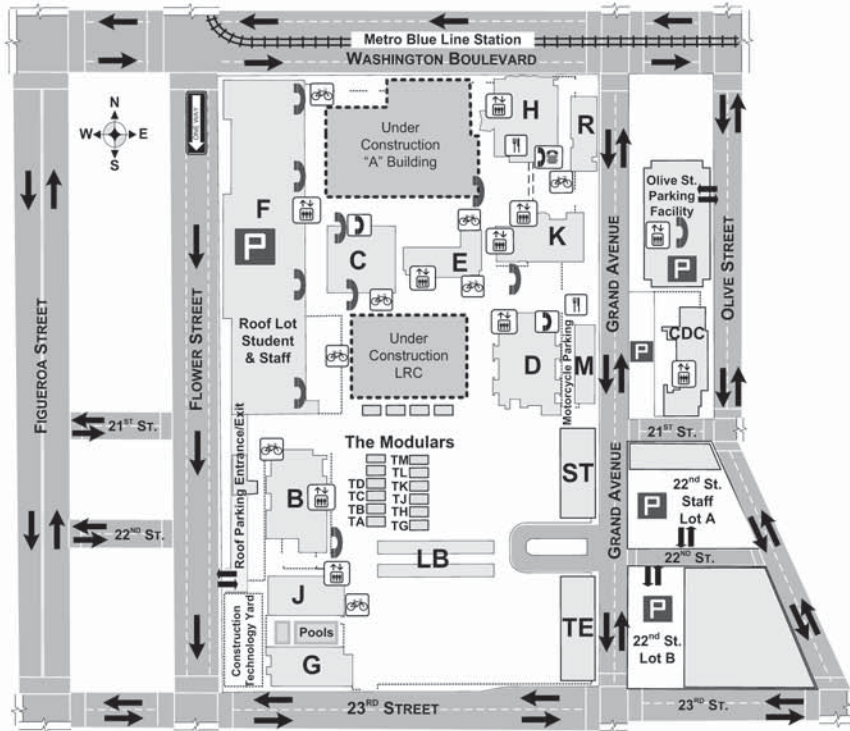

LEGEND:
 [Elevator icon] Elevator [Public pay phone & TDD icon] Public pay phone & TDD [Food icon] Food [Emergency Blue Phone icon] Emergency Blue Phone
 [Bicycle rack icon] Bicycle rack [Public pay phone icon] Public pay phone [P icon] Parking

B BUILDING
 Apprenticeship/Coop. Ed.
 Construction Technologies

C BUILDING
 Copy Center
 Learning Skills Center
 Mail Room
 Student Activities/ASO
 Student Employment Center
 Writing Center

CDC BUILDING
 Child Development Center

D BUILDING
 Architecture Technology
 Art Trades/Fashion
 College Sheriff
 Physical Plant Office

E BUILDING
 Disabled Student Programs & Services
 Jefferson High School
 Student Health Center

F BUILDING
 Automotive Technologies
 Health
 Machine Shop CNC
 Receiving
 Sign Graphics
 Visual Communications
 Welding Program

G BUILDING
 Gymnasium Men's & Women's

H BUILDING
 Cafeteria
 Culinary Arts
 Garden Room

J BUILDING
 Athletics
 Physical Education

K BUILDING
 Bookstore
 Business Administration
 Community & Economic Development
 Computer Applications & Office Technology
 Computer Information Systems
 Electronics Technology
 Fitness Center
 Media Services
 Non Credit
 Science

LB BUILDING
 Distance and Distributed Learning
 Labor Center
 Library
 Webmaster

M BUILDING
 Physical Plant Shops

R BUILDING
 Cosmetology

ST BUILDING
 Academic Affairs
 Administrative Offices
 Admissions & Records
 Assessment Center
 Bridges to Success Center
 Business Office
 CalWorks/GAIN
 Career Center
 Compliance Office
 Continuing Education
 Counseling Center
 EOPS/CARE
 Financial Aid
 Information Center
 International Student Program
 Matriculation
 Non-credit
 Personnel/Payroll
 PUENTE Program
 School Relations
 Student Services
 University Transfer Center
 Veterans Services
 Workforce & Econ. Dev.
 Worksource Center

TE BUILDING
 Behavioral/Social Sciences
 Language Arts/Humanities
 Mathematics

THE MODULARS
 Allied Health/Health Occupations
 Temporary Classrooms

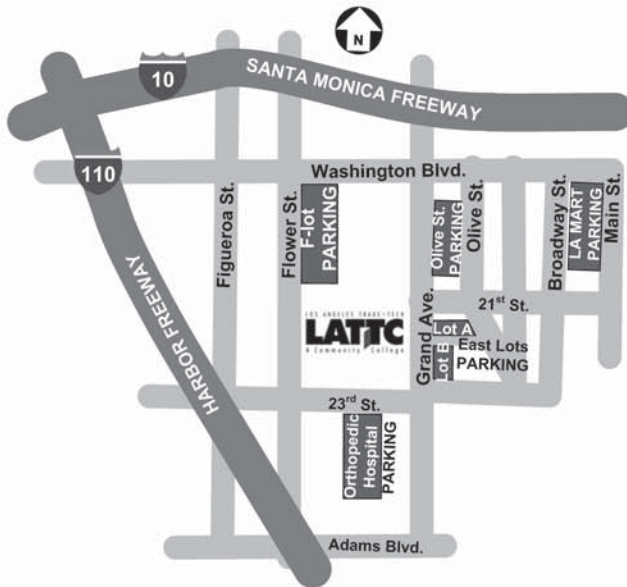

4/7/10 -ty

Please note: At the time of publication, current information was used. Construction demands will create changes and information will always be available at the College Sheriff's Office, D150, (213) 763-3600, 24 hours a day, 7 days per week. LATTC provides adequate parking for students, staff and visitors. However, since demand is high during the first three weeks of Fall and Spring semesters, overflow parking will be available in the East lot of the LA Mart at 1933 S. Broadway. These spaces are accessible from Broadway or Main Streets just south of Washington. The LA Mart East lot offers free parking to students with a valid college parking permit for the first three weeks of the Fall and Spring semesters only. Beginning with the fourth week, students must use other designated college lots.



400 West Washington Blvd., Los Angeles, CA 90015
Ph 213-763-7000
www.lattc.edu

Non-Profit Org.
U.S. Postage
PAID
Los Angeles, CA
Permit No. 33366

Materials available in an alternative format upon request.

